

# MX241P Series

Thermal Transfer / Direct Thermal  
Industrial Barcode Printers



Series Lists:

MX241P/MX341P/MX641P

## Service Manual

# Copyright Information

**©2022 TSC Auto ID Technology Co., Ltd.**

The copyright in this manual, the software and firmware in the printer described are owned by TSC Auto ID Technology Co., Ltd. All rights reserved.

CG Triumvirate is a trademark of Agfa Corporation. CG Triumvirate Bold Condensed font is under license from the Monotype Corporation. Windows is a registered trademark of Microsoft Corporation.

All other trademarks are the property of their respective owners. Information in this document is subject to change without notice and does not represent a commitment on the part of TSC Auto ID Technology Co. No part of this manual may be reproduced or transmitted in any form or by any means, for any purpose other than the purchaser's personal use, without the expressed written permission of TSC Auto ID Technology Co.



# Table of Contents

1. Fundamental of the System.....	1
1.1 Printer Overview .....	1
Front View.....	1
Interior View .....	2
Rear View .....	3
2. Electronics.....	4
2.1 Summary of the Board Connectors .....	4
2.2 Interface Pin Configuration.....	6
3. Mechanism.....	8
3.1 Remove the Lower Front Panel.....	8
3.2 Remove the Electronics Cover.....	9
3.3 Removing the Media Cover.....	10
3.4 Replacing the Platen Roller Assembly .....	11
3.5 Replacing the Print head ASS'Y.....	12
3.6 Replacing the LCD Panel Module .....	14
3.7 Replacing the LCD Control Board & LCD Touch Panel.....	15
3.8 Replacing Front Panel Buttons Control Board.....	16
3.9 Replacing the Label Supply Spindle.....	17

3.10 Replacing the Power Supply Unit.....	18
3.11 Replacing the Internal Rewinder DC Motor .....	19
3.12 Replacing Multi-interface Board .....	20
3.13 Replacing the Main Board.....	21
3.14 Replacing the Stepping Motor Assembly.....	22
3.15 Replacing the Gap/Black Mark Sensor Module .....	23
3.16 Cutter Module Installation (Option).....	24
3.17 Peel-off Kit Installation (Option).....	26
3.18 Internal Rewinding Kit Installation (Option).....	32
3.19 Replacing WiFi Housing.....	35
3.20 Install WiFi+BT Combo Module.....	36
4. TroubleShooting .....	37
4.1 Knob Adjustment.....	40
4.2 Mechanism Fine Adjustment to Avoid Ribbon Wrinkles.....	41
4.3 Suggestion of Ribbon Tension Adjustment .....	44
5. Maintenance.....	46
Revise History .....	48



# 1. Fundamental of the System

## 1.1 Printer Overview

### Front View



1. LED indicators
2. LCD display
3. Front panel buttons
4. USB host x 2
5. Media view window
6. Paper exit chute
7. Media cover

## Interior View

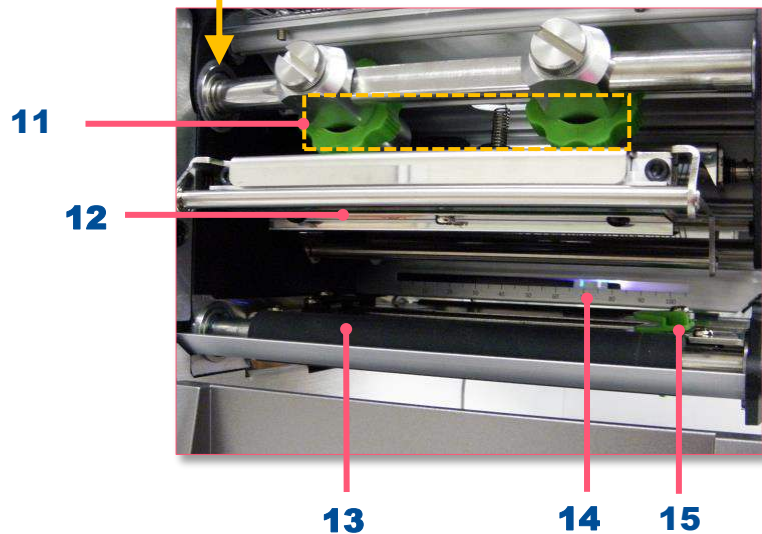
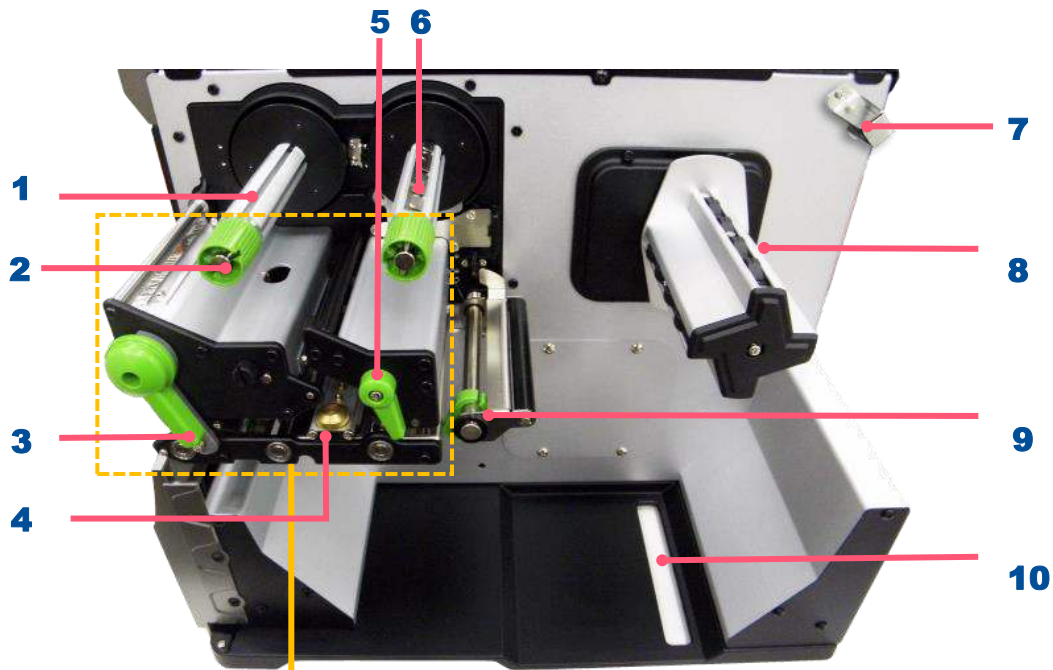

1. Ribbon rewind spindle
2. Ribbon rewind tension adjustment knobs
3. Print head release lever
4. Media sensor position adjustment knob
5. Label guide bar release lever
6. Ribbon supply spindle
7. Media capacity sensor
8. Label supply spindle
9. Rear label guide
10. External label entrance chute
11. Print head pressure adjustment knobs
12. Print head
13. Platen roller
14. Media sensor (Black mark :Blue ; Gap: White)
15. Front label guide

# Rear View

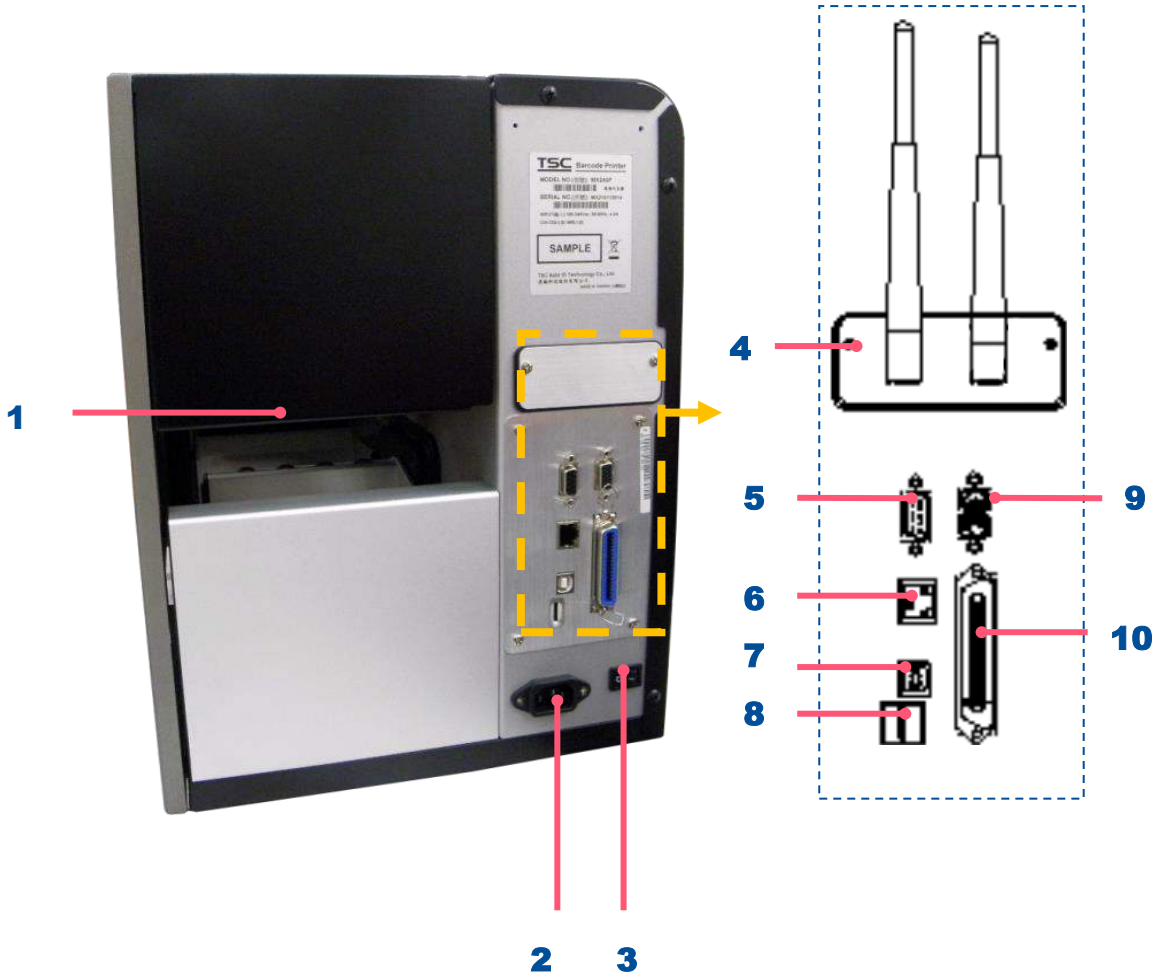

- 1. External label entrance chute
- 2. Power cord socket
- 3. Power switch
- 4. Slot-in Wi-Fi module (Option)
- 5. RS-232C interface
- 6. Ethernet interface
- 7. USB interface
- 8. Micro SD card socket
- 9. GPIO interface (Option)
- 10. Centronics interface (Option)

**Note:**  
The interface picture here is for reference only. Please refer to the product specification for the interfaces availability.

## 2. Electronics

### 2.1 Summary of the Board Connectors

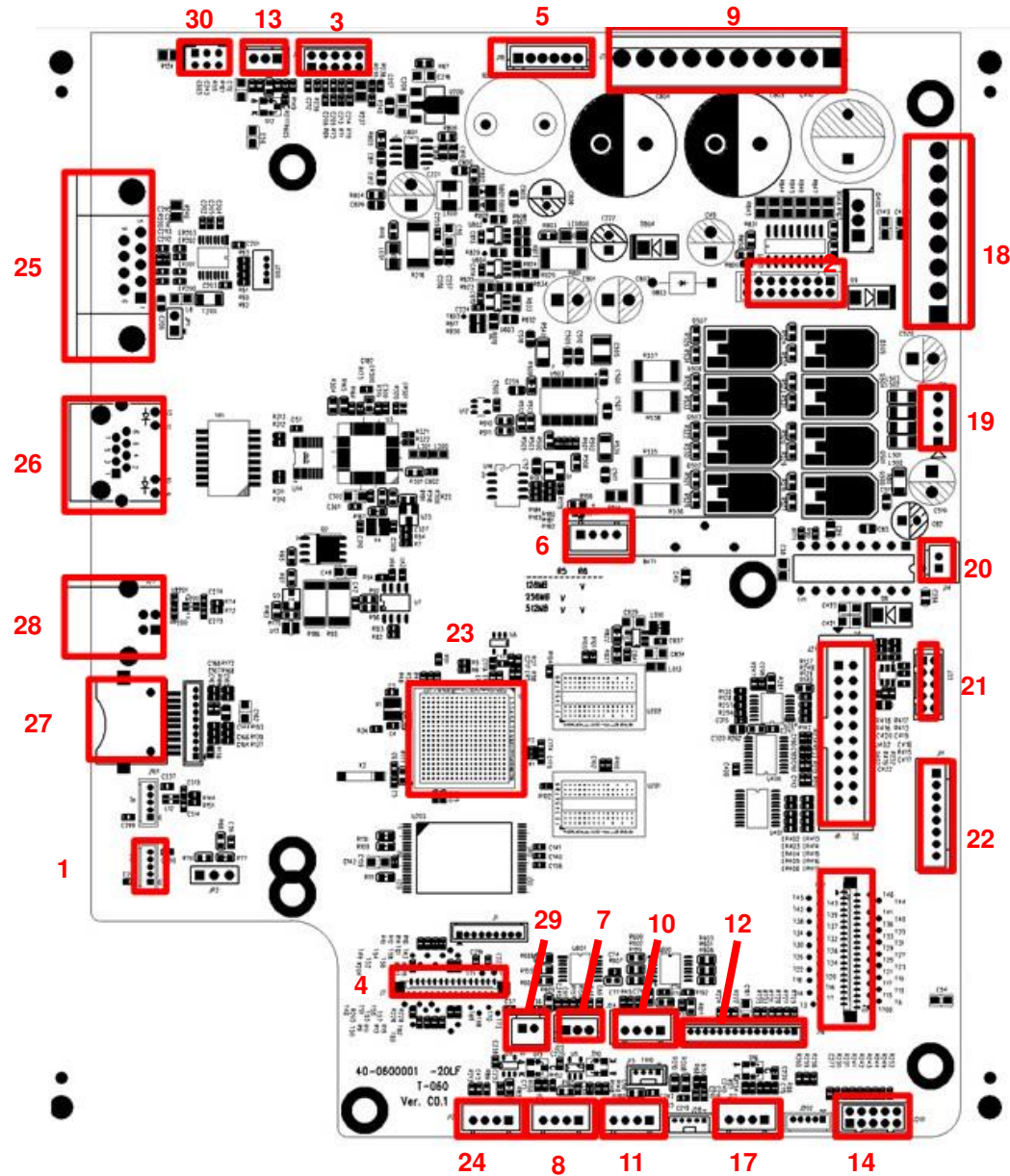



Connector	Description	Connector	Description
1	USB Host connector	27	MICRO SD card socket
2	Power supply output (5V/36V DC) connector	28	USB interface
3	Wi-Fi Module connector	29	Upper BM Sensor Connector
4	Parallel Port board connector	30	Wi-Fi interface
5	GPIO interface board connector		
6	Head open sensor connector		
7	Gap sensor connector		
8	Ribbon encoder sensor connector		
9	Power supply output (24V DC) connector		
10	Lower BM Sensor connector		
11	Paper Distance Sensor connector		
12	BT module connector		
13	Print head connector		
14	LCD panel connector		
15	Ribbon end sensor connector		
16	TPH Power (24V DC) connector		
17	Stepping motor connector		
18	Cutter/peel-off connector		
19	Paper REWIND connector		
20	Micro processor		
21	RS-232C connector		
22	Ethernet interface		
23	MICRO SD card socket		
24	USB interface		
25	Upper BM Sensor Connector		
26	Wi-Fi interface		

## 2.2 Interface Pin Configuration

### RS-232C

PIN	CONFIGURATION
1	+5 V
2	TXD
3	RXD
4	CTS
5	GND
6	RTS
7	N/C
8	RTS
9	N/C

### USB Device

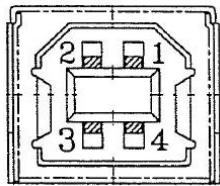

PIN	CONFIGURATION
1	N/C
2	D-
3	D+
4	GND

Ethernet

PIN	CONFIGURATION
1	Tx+
2	Tx-
3	Rx+
4	N/C
5	N/C
6	Rx-
7	N/C
8	N/C

## 3. Mechanism

### 3.1 Remove the Lower Front Panel

1. Remove 2 screws (fastened by  $7.5 \text{ kg} \pm 15\% \text{ kg-cm}$ ) and pull out the lower front panel.

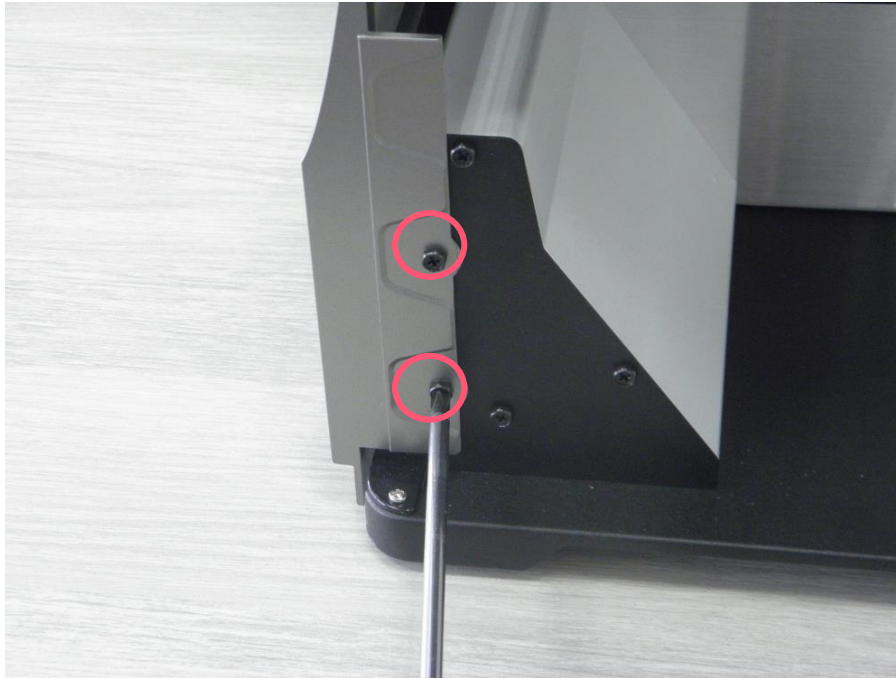

Lower front panel

## 3.2 Remove the Electronics Cover

1. Open printer media cover to remove 1 screw inside the printer.
2. Remove 6 screws on electronics cover.
3. Remove the electronics cover



4. Reassemble the parts in the reverse procedures.

### 3.3 Removing the Media Cover

1. Refer to section 3.2 to remove the electronics cover.
2. Remove 3 screws from each hinge. Be careful the media cover may fall out from the printer.
3. Take out the media cover from the printer.

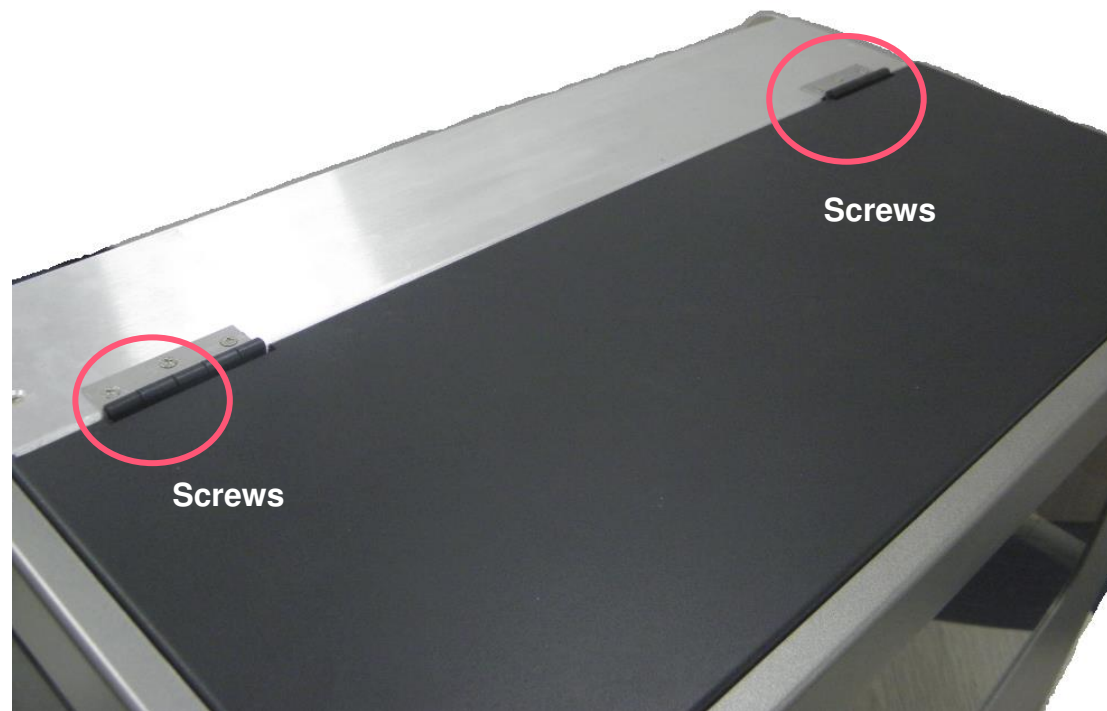

4. Reassemble the parts in the reverse procedures.

## 3.4 Replacing the Platen Roller Assembly

1. Open printer media cover.
2. Disengage print head release lever.
3. Remove 3 screws from the platen holder.
4. Take out the platen holder, tear bar and platen roller assembly and replace a new platen roller assembly.

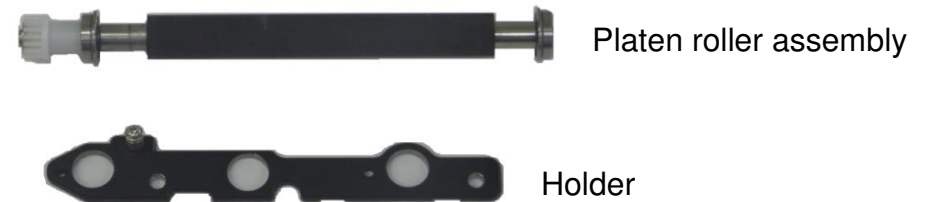
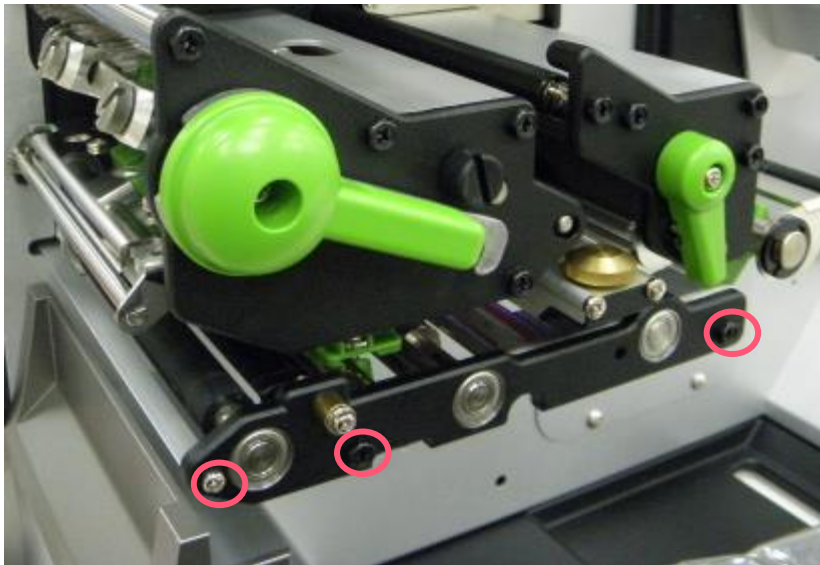

5. Reassemble the parts in the reverse procedures.

## 3.5 Replacing the Print head ASS'Y

1. Loosen the print head secure screw counterclockwise until it can be taken out from the mechanism.
2. Disengage the print head release lever.

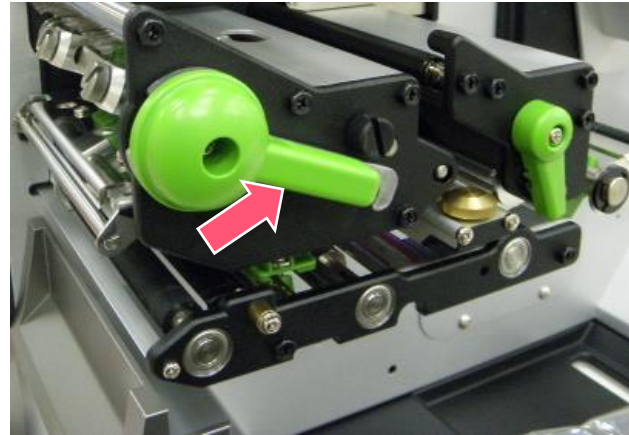
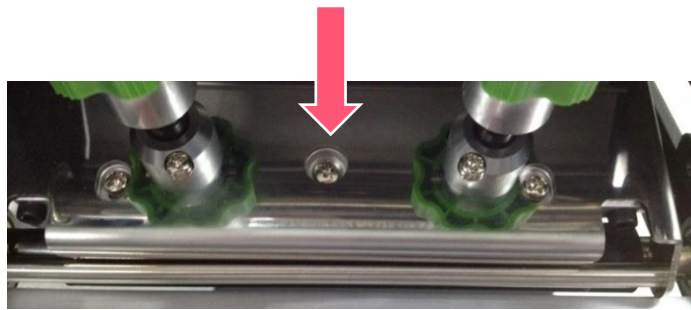

3. Carefully disconnect connectors from the print head assembly. Please do not pull the cable to right and left side alternatively in order to disconnect it from the print head connector. Please use the flat screw driver to push at the key in the middle of the connector. When the connector becomes loose from the print head connector, you can disconnect it.





4. Remove/Replace the print head assembly.
5. Connect the print head cable and carefully slide print head assembly into the print mechanism. Make sure the two locating protrusion pins on the print mechanism mounting plate snap into the locating holes on the print head.

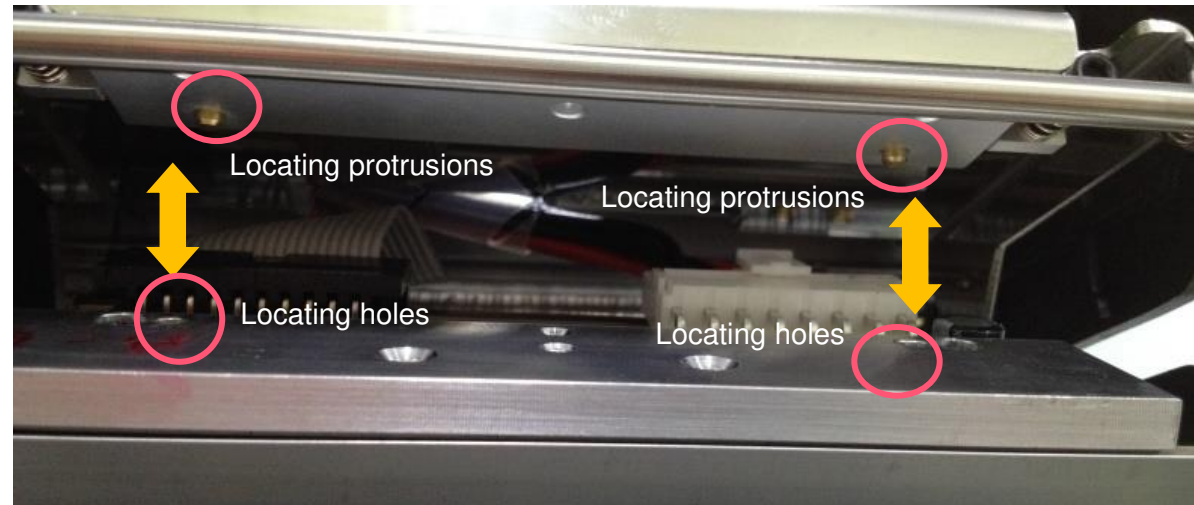

6. Reassemble the parts in the reverse procedures.

**Note: Please use the come with new print head secure screw to replace the print head assembly. DO NOT re-use the original screw.**

## 3.6 Replacing the LCD Panel Module

1. Follow the previous step (refer to section 3.2) to remove the electronics cover.
2. Remove the marked fix LCD panel module two screws and disconnect one connector on USB host board
3. Remove the module connecting cable & harness.

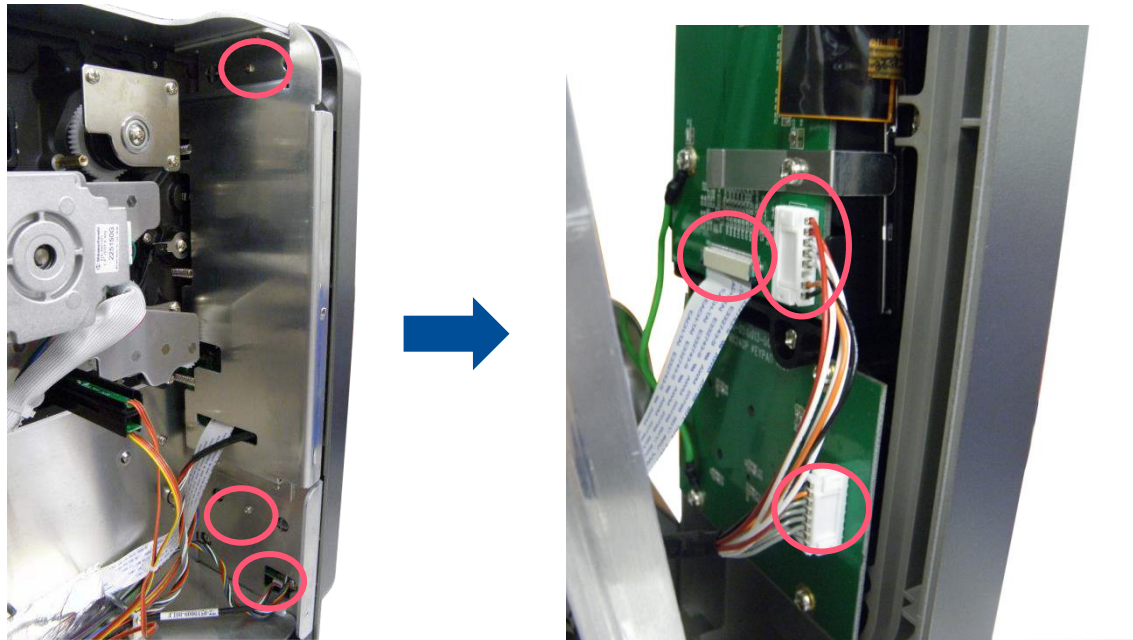

4. Reassemble the parts in the reverse procedures.

## 3.7 Replacing the LCD Control Board & LCD Touch Panel

1. Follow the previous step (refer to section 3.7) to remove the LCD panel module.
2. Remove the FPC harness from the LCD control board.

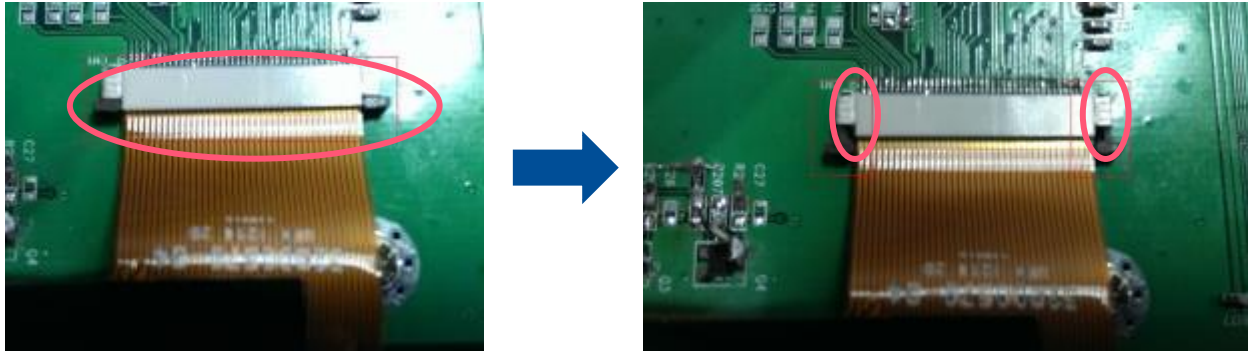

3. Remove the marked six fixed screws (fastened by  $5 \text{ kg} \pm 15\% \text{ kg-cm}$ ) to take out LCD control board, the holder and touch panel can be removed

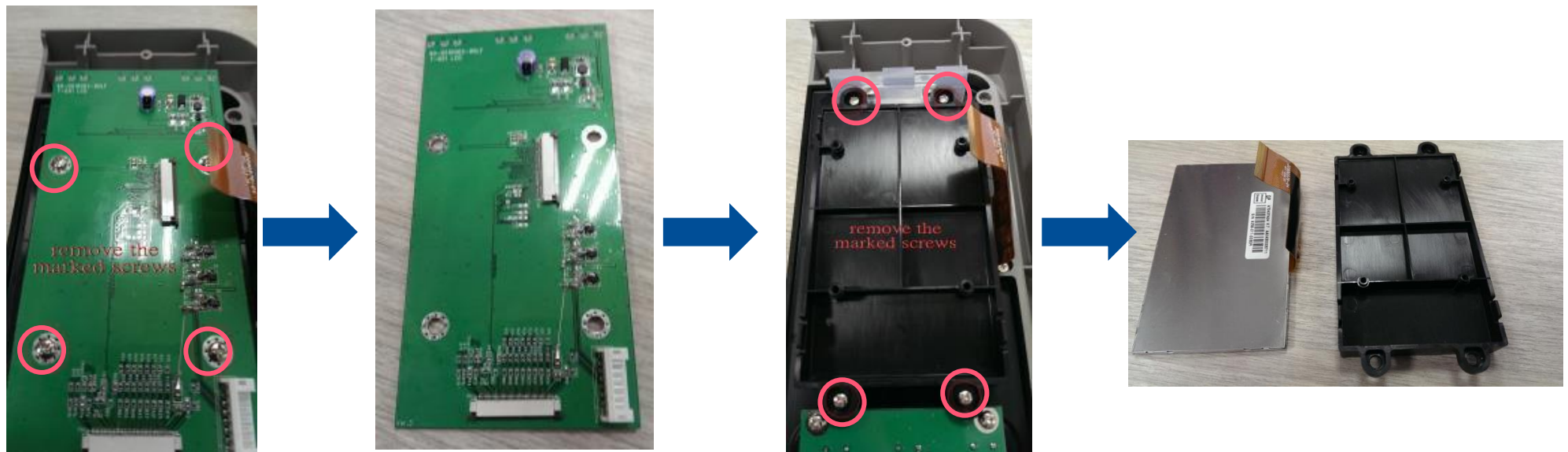

4. Reassemble the parts in the reverse procedures.

## 3.8 Replacing Front Panel Buttons Control Board

1. Remove the marked four fix screws from the buttons control board, then you can take off the button control board and buttons rubber pad.

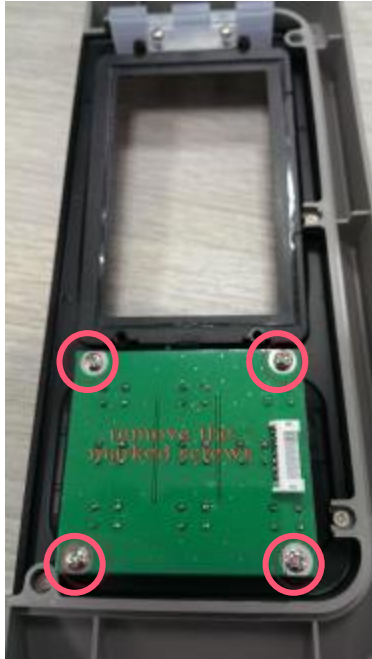

2. Reassemble the parts in the reverse procedures.

### 3.9 Replacing the Label Supply Spindle

1. Refer to section 3.2 to remove the electronic cover.
2. Remove the marked fix screw from the label supply spindle.
3. Draw out the label supply spindle for replacement.

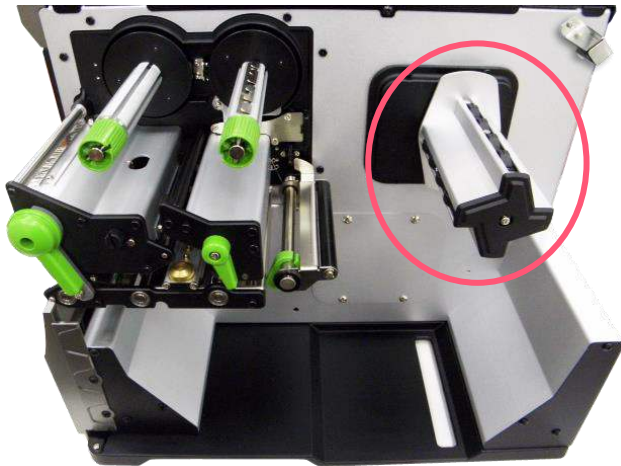

4. Reassemble the parts in the reverse procedures.

## 3.10 Replacing the Power Supply Unit

1. Please refer to section 3.3 to remove the power supply unit and you can see the DC motor.
2. Refer to section 3.2 to remove the electronics cover.
3. Remove 4 screws and 2 connectors.
4. Remove/Replace the power supply unit.

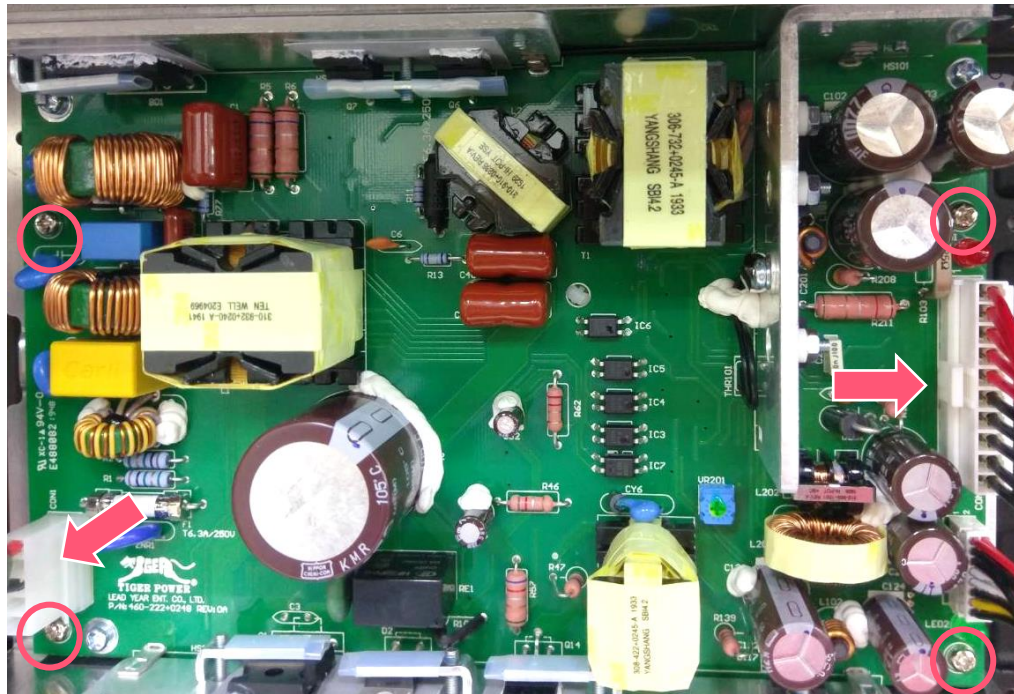

5. Reassemble the parts in the reverse procedures.

### 3.11 Replacing the Internal Rewinder DC Motor

1. Please refer to the power supply change procedures (section 3.10) to remove the marked four fix screws & cable. Then you can see the DC motor.
2. Remove the marked fix two screws from the DC motor. Remove the DC motor cable connector from the main board.
3. Then you can remove the DC motor.

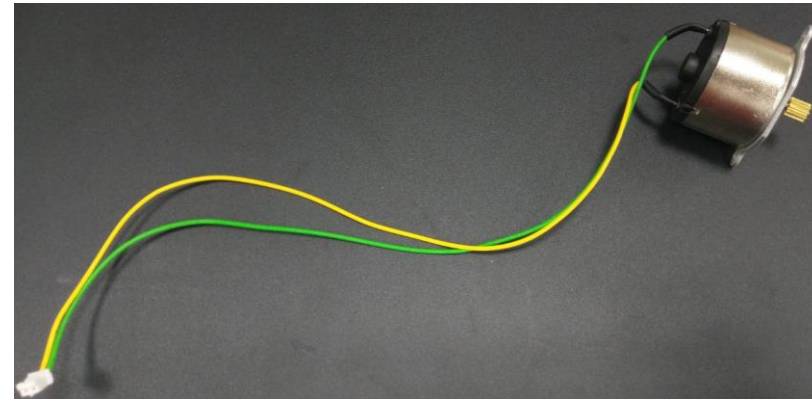
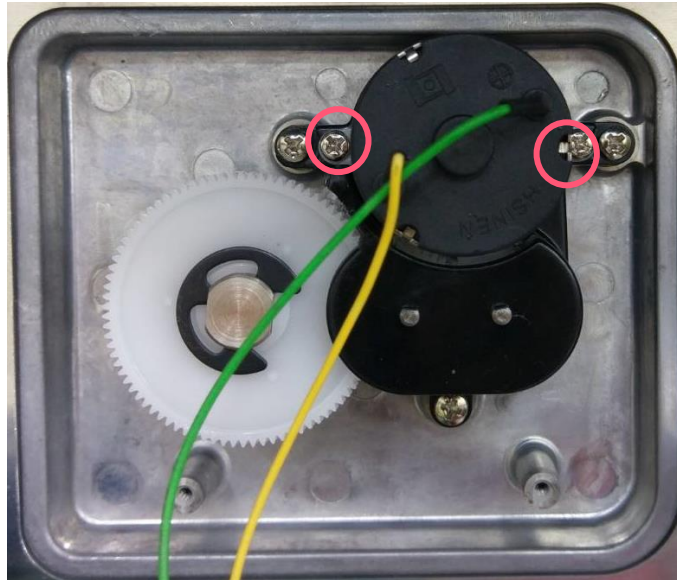

4. Reassemble the parts in the reverse procedures.

## 3.12 Replacing Multi-interface Board

1. Refer to section 3.1 to remove the electronics cover.
2. Remove 4 screws to loosen the parallel port and GPIO port (The standard Board does not have GPIO port. Board with GPIO is optional kit).
3. Remove 2 screws and 2 connectors from the connector.

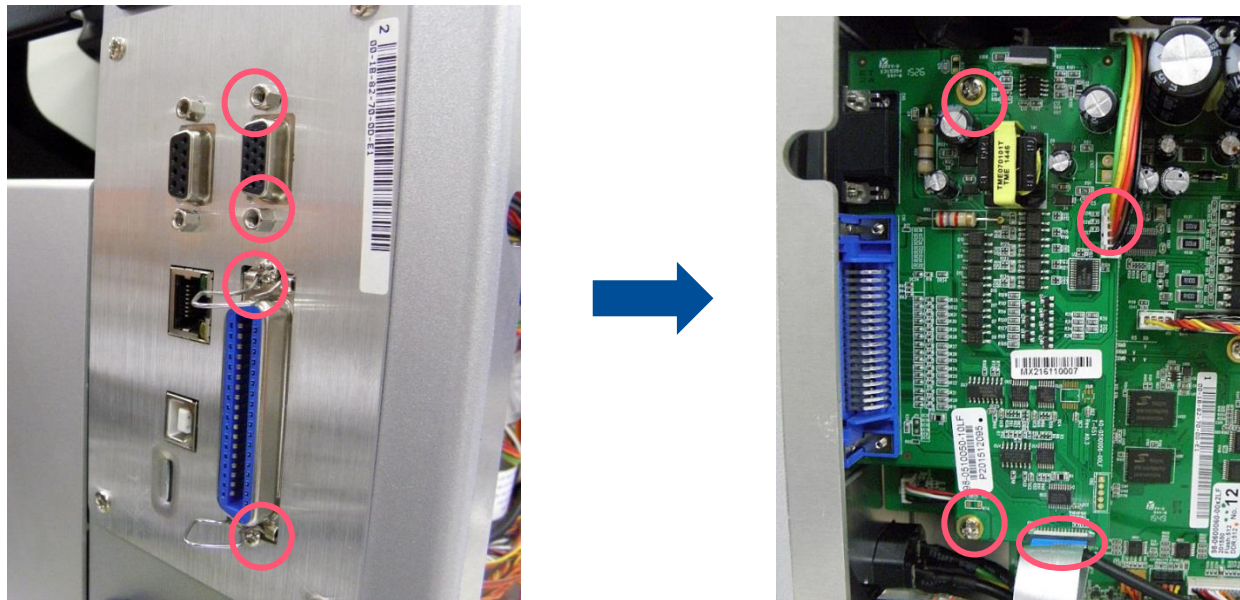

4. Remove/Replace the multi-interface board.
5. Reassemble the parts in the reverse procedures.



### 3.13 Replacing the Main Board

1. Refer to section 3.1 to remove the electronics cover. Refer to section 3.12 to remove the multi-interface board.)
2. Remove 2 screws to loosen the serial port.
3. Remove 2 copper pillars, 3 screws, and all of the connectors from the main board.
4. Remove/Replace the main board.



5. Reassemble the parts in the reverse procedures.

## 3.14 Replacing the Stepping Motor Assembly

1. Refer to section 3.1 to remove the electronics cover.
2. Remove 4 screws and 1 connector on the stepping motor assembly.
3. Remove/Replace the stepping motor assembly (including belt, gears, stepping motor)

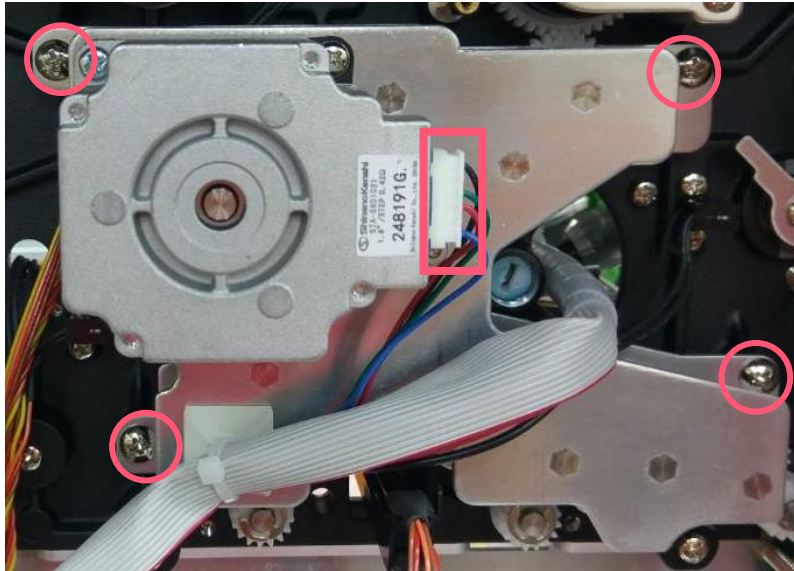

4. Reassemble the parts in the reverse procedures.

## 3.15 Replacing the Gap/Black Mark Sensor Module

1. Refer to section 3.1 to remove the electronics cover.
2. Disconnect the gap/black mark sensor connectors from the main board.

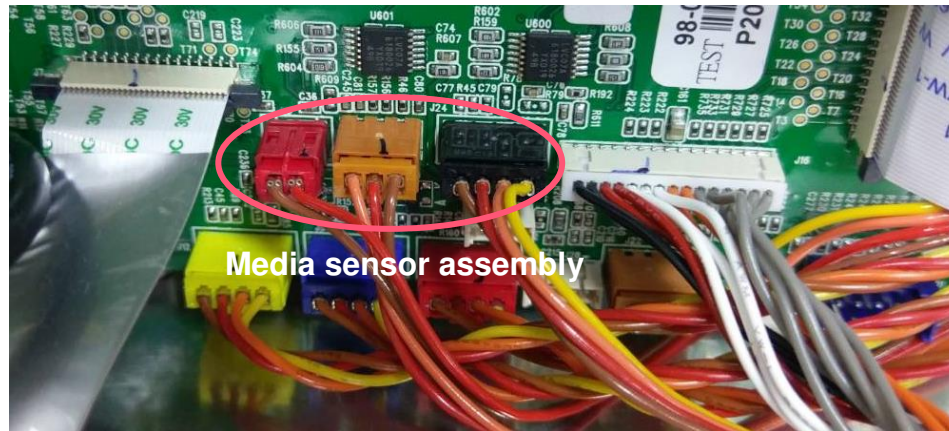

3. Pull out the media sensor module.
4. Remove/Replace the gap/black mark sensor.

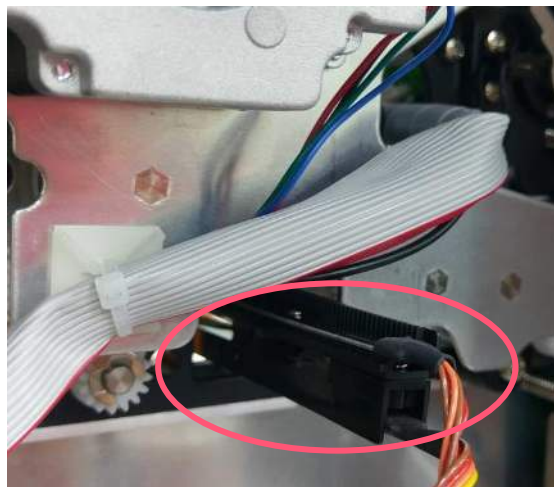

Gap/Black mark sensor connector

5. Reassemble the parts in the reverse procedures.

## 3.16 Cutter Module Installation (Option)

1. Refer to section 3.1 to remove the lower front pane
2. Loose 2 screws to take out the lower front panel in the right direction as red arrow indicated below.

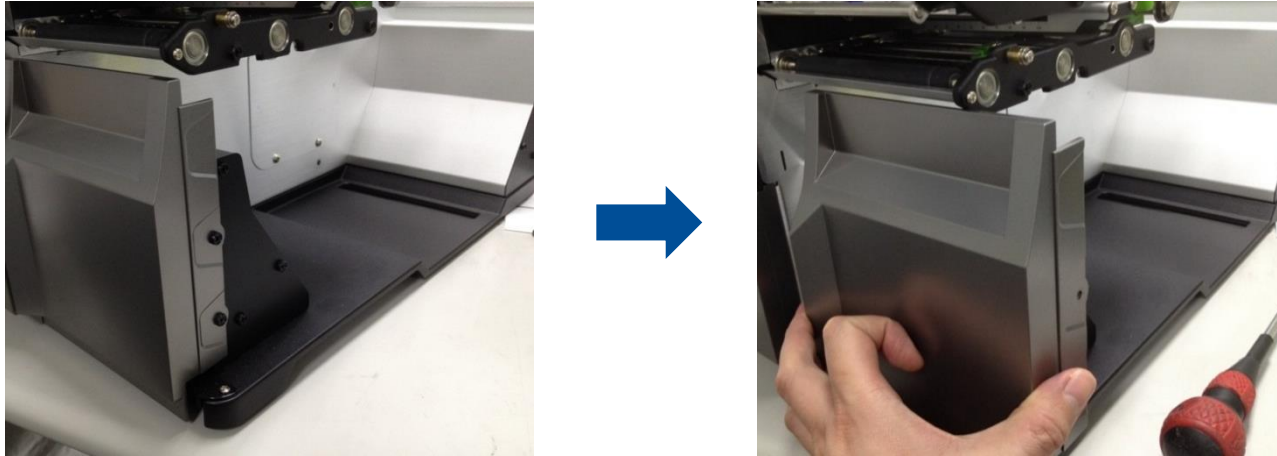

3. Plug the cutter mini DIN cable connector into the cutter/peel-off connector. The triangle mark on the connector must be at the front side.

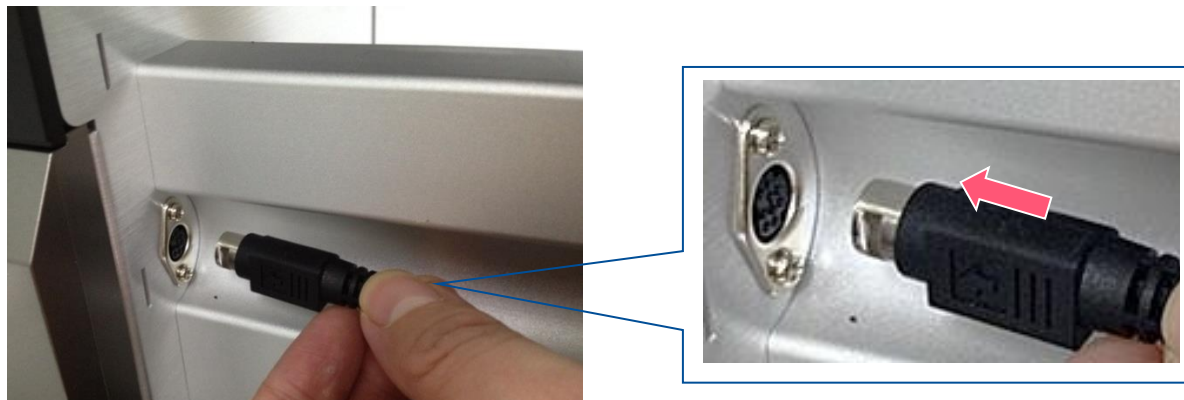

4. Put 2 locating protrusions into locating holes as red arrows indicated.
5. Fasten the 2 screws.

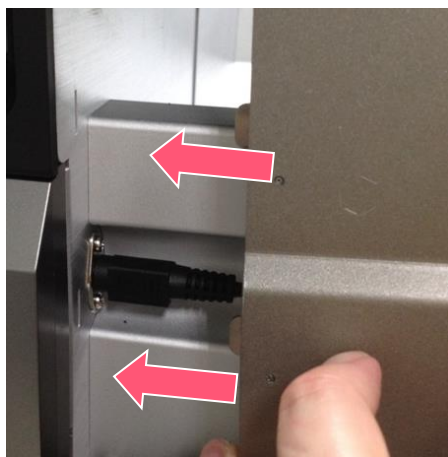

### 3.17 Peel-off Kit Installation (Option)

Peel-off Kit parts list:



1. Peel-off sensor module
2. Peel-off roller module
3. Rewind spindle module
4. Four screws

### Peel-off Sensor Module Installation

1. Loosen 2 screws to take out the lower front panel.
2. Plug the peel sensor mini DIN cable connector into the cutter/peel-off connector. The triangle mark on the connector must be at the front side.

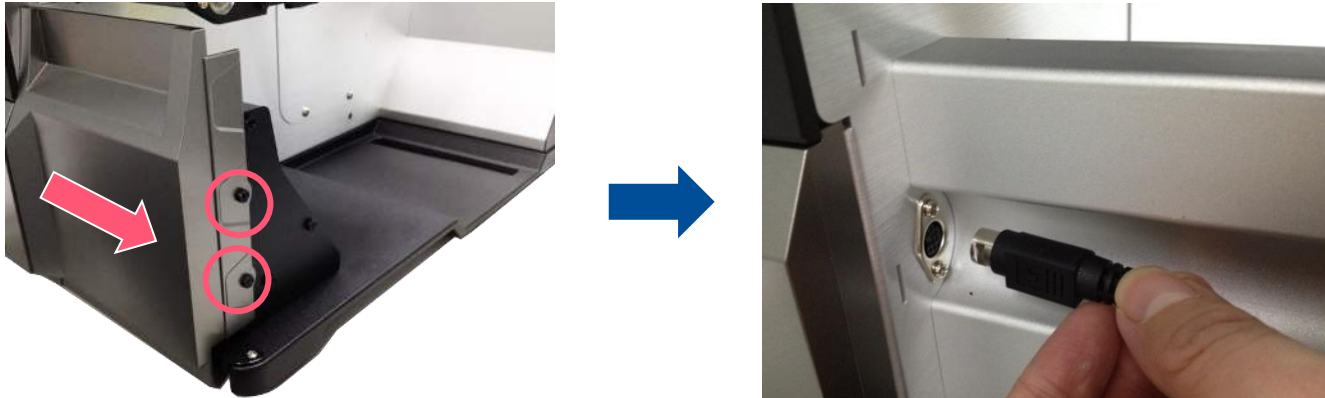

3. Put 2 locating protrusions into locating holes as red arrows indicated.
4. Fasten the 2 screws back into the fixing holes. Finished peel-off sensor module installation.



## Peel-off Roller Module Installation

1. Turn the thumb screw on the peel-off roller module in the counterclockwise direction until taking out the screw.
2. There is a locating hole between media sensor and rear paper-feed roller (most right one).

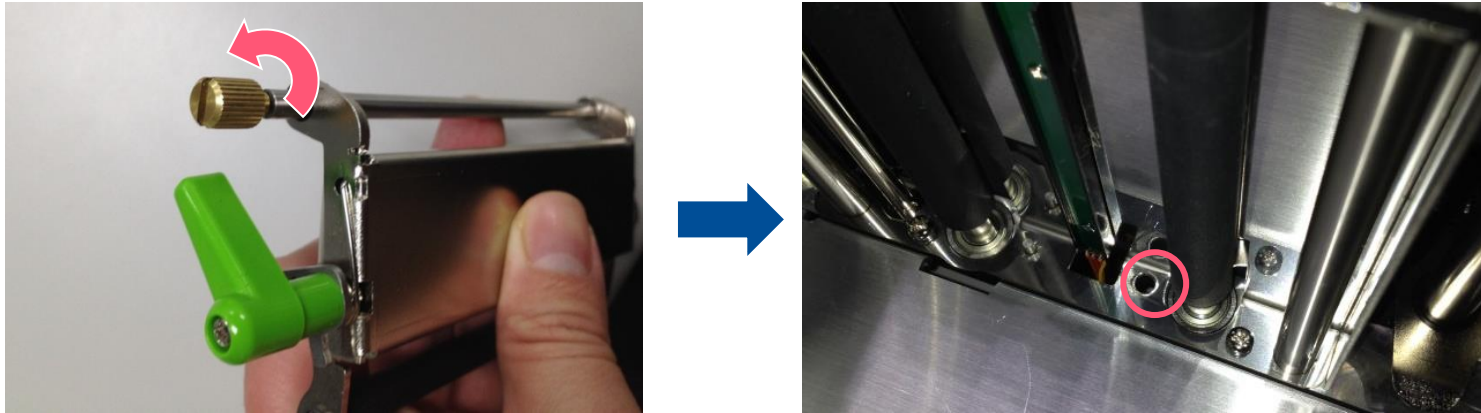

3. Put the shaft of the peel-off roller module into the locating hole.

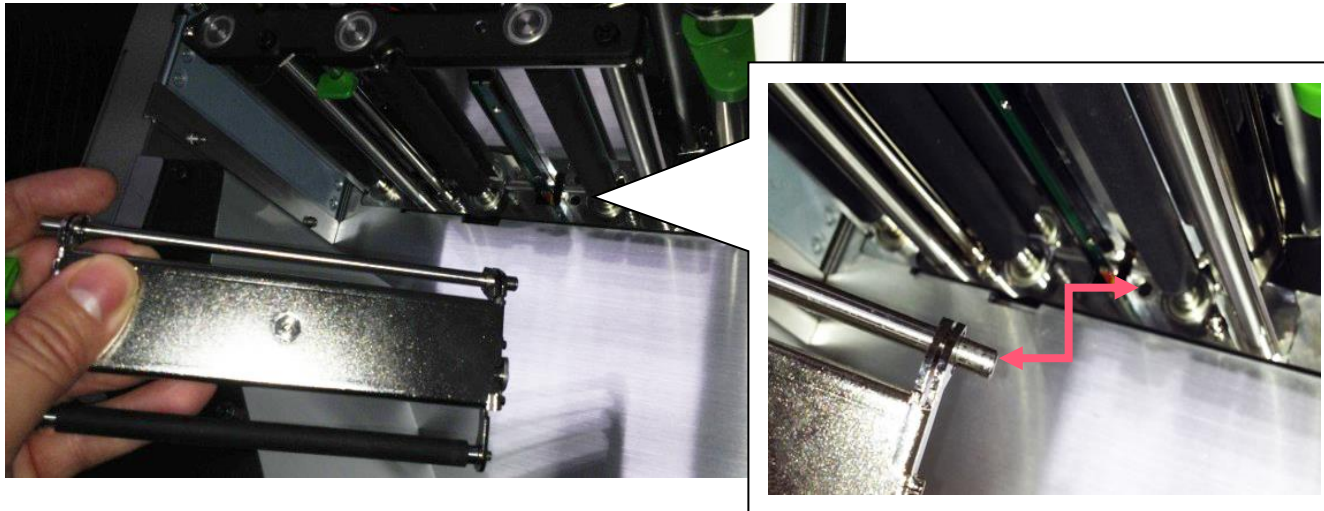



4. After putting shat into locating hole, at certain angle, the module would not be able to put inside. Please turn the module in the clockwise direct to put the module inside.

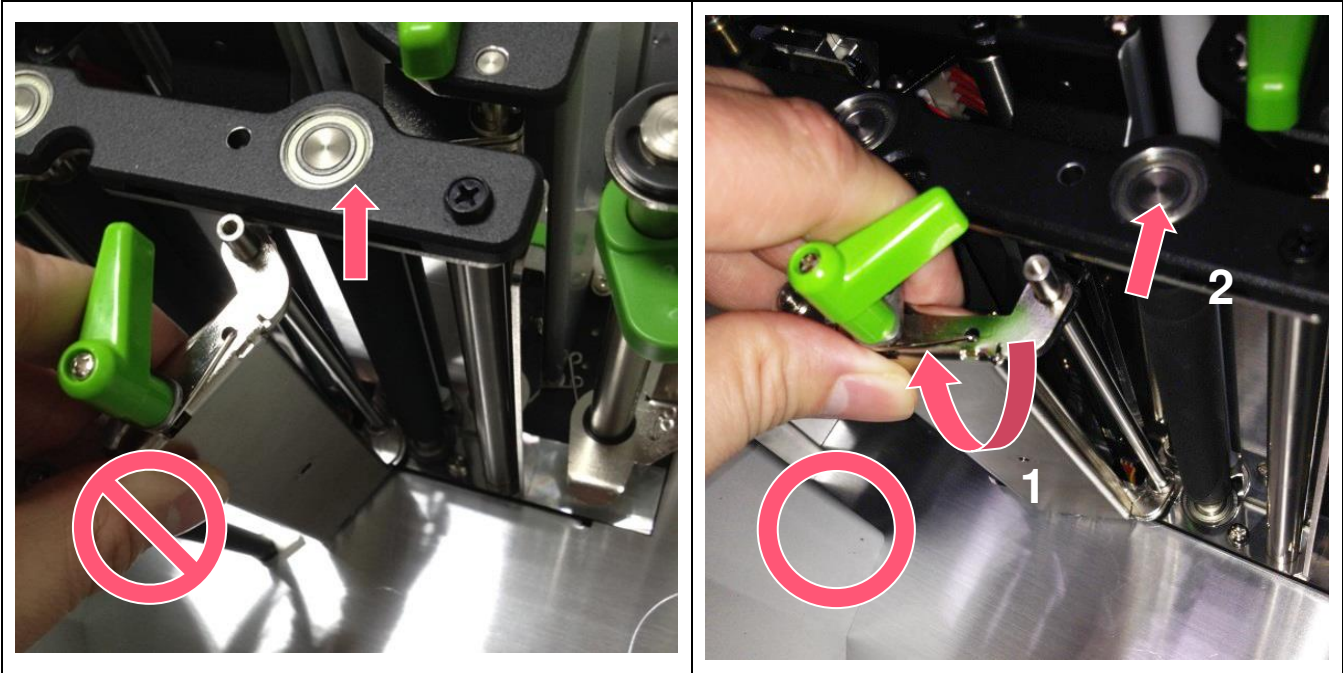

5. Put back the golden color screw, and turn it in the clockwise direction to fix the screw.

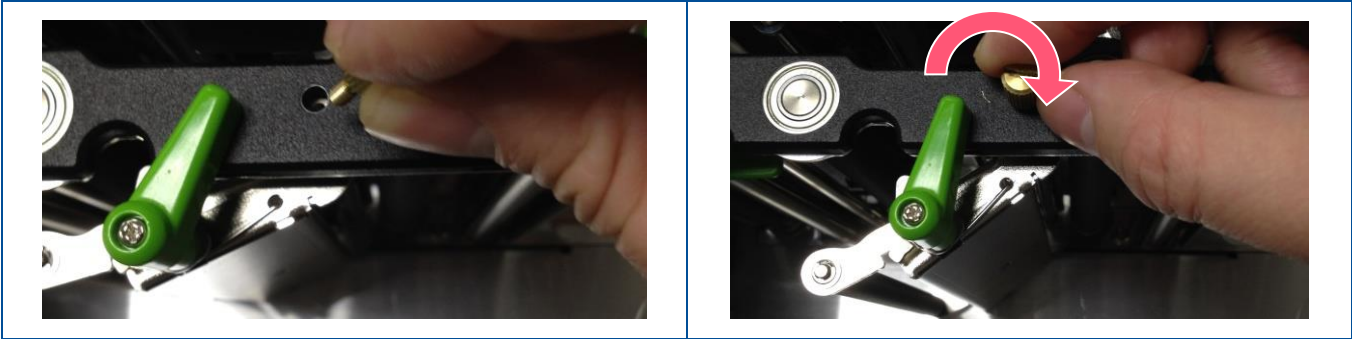

6. Pushing the peel-off roller module upward.

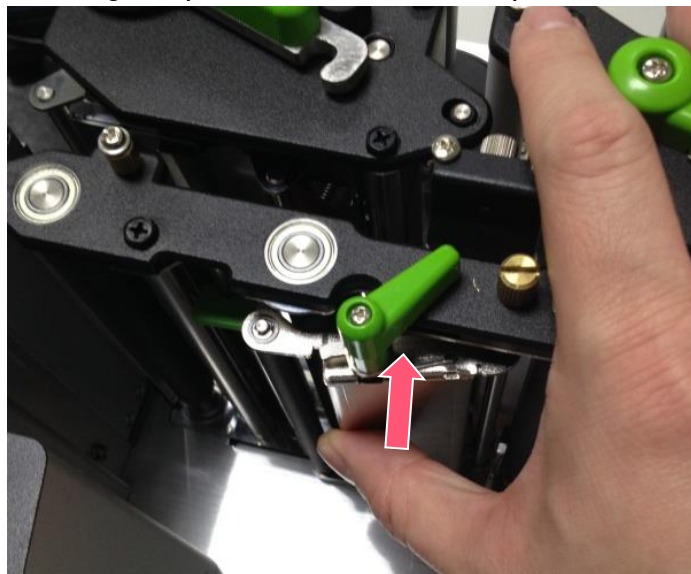

7. After hearing the click sound, the module is fixed to its position without dangling. Finished the installation of peel-off roller module.



### Peel-off Roller Module Installation

1. Remove 4 screws below the label supply spindle to take out the rewind spindle cover.
2. Put the whole rewind spindle module inside the hole after taking out the cover.

Make sure the direction of the module is same with left side picture.(small PCB is on the bottom and the motor is on the top of module)

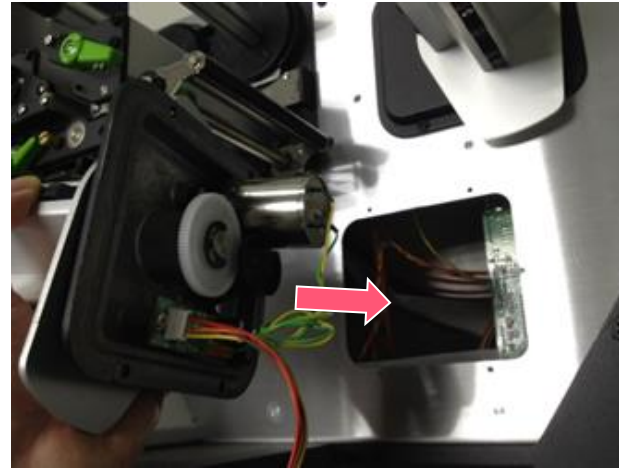
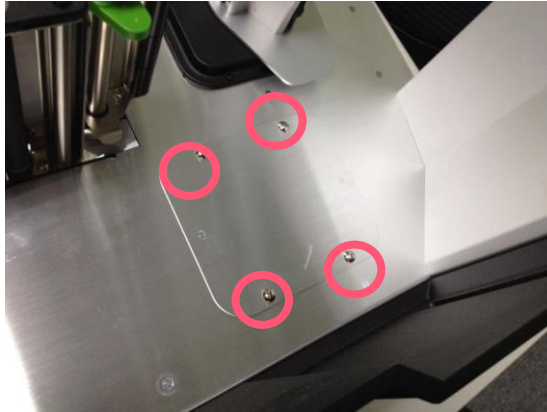

3. Using screws which come with module to fix the whole rewind spindle module.
4. Refer to section 3.2 to remove the electronics cover. Connect the 8-pins connector into main board socket. Reassemble the electronics cover.

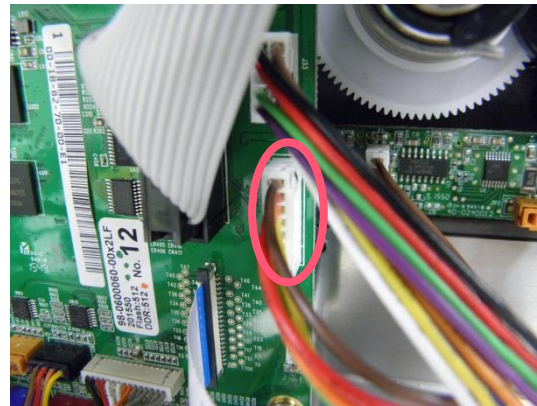

### 3.18 Internal Rewinding Kit Installation (Option)

Peel-off Kit parts list:



1. Loosen 2 screws to take out the lower front panel and take out the front panel

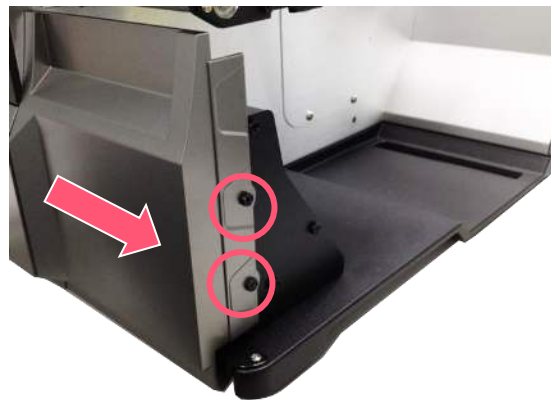

2. Put 3 locating protrusions into locating holes.
3. Fasten the 2 screws back into the fixing holes.

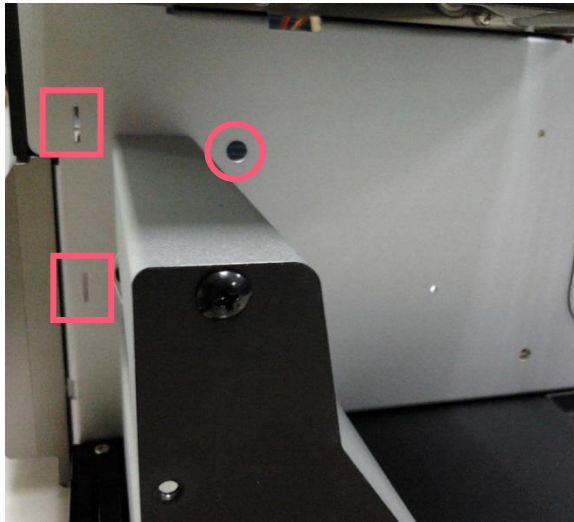

4. Fasten the 2 screws back into the fixing holes.
5. Remove 4 screws below the label supply spindle to take out the rewind spindle cover.

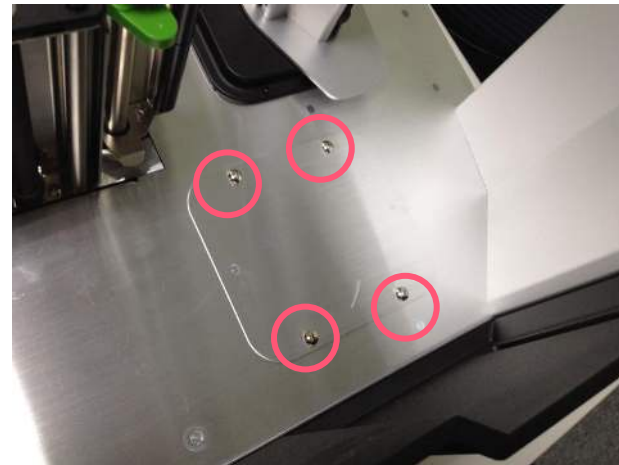
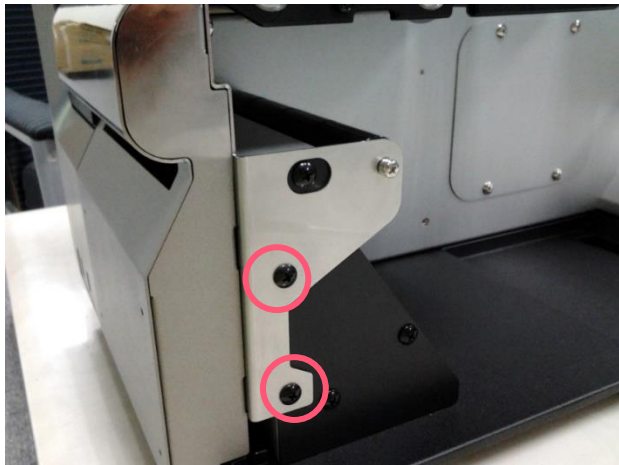

6. Fasten the 3 screws to fix the cover as below.
7. Put the whole rewind spindle module inside the hole.  
Make sure the direction of the module is same as picture. (Small PCB is on the bottom and the motor is on the top of module)
8. Using 4 screws which come with module to fix the whole rewind spindle module.

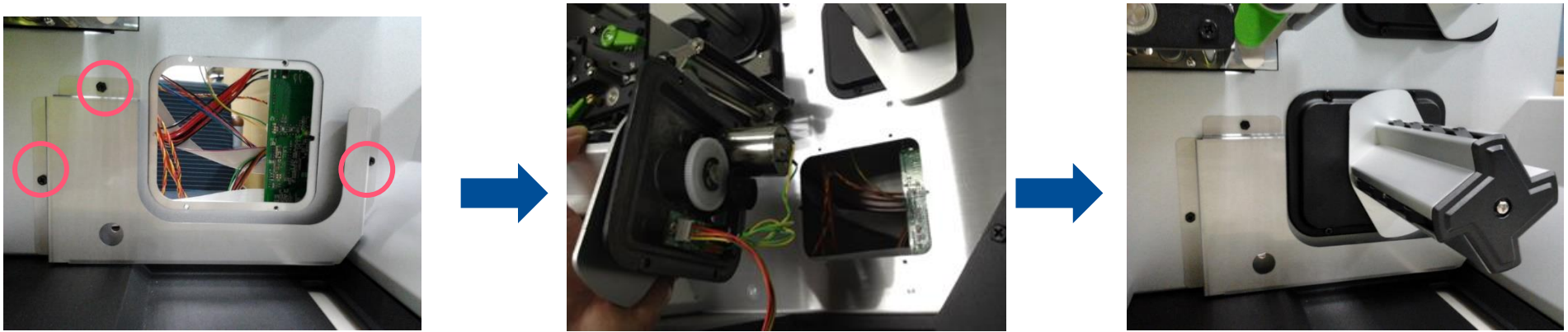

9. Refer to section 3.2 to remove the electronics cover. Connect the 8-pins connector into main board socket.
10. Install the rewind label guide to the hole as picture showing. Fix it by one screw. Reassemble the electronics cover.

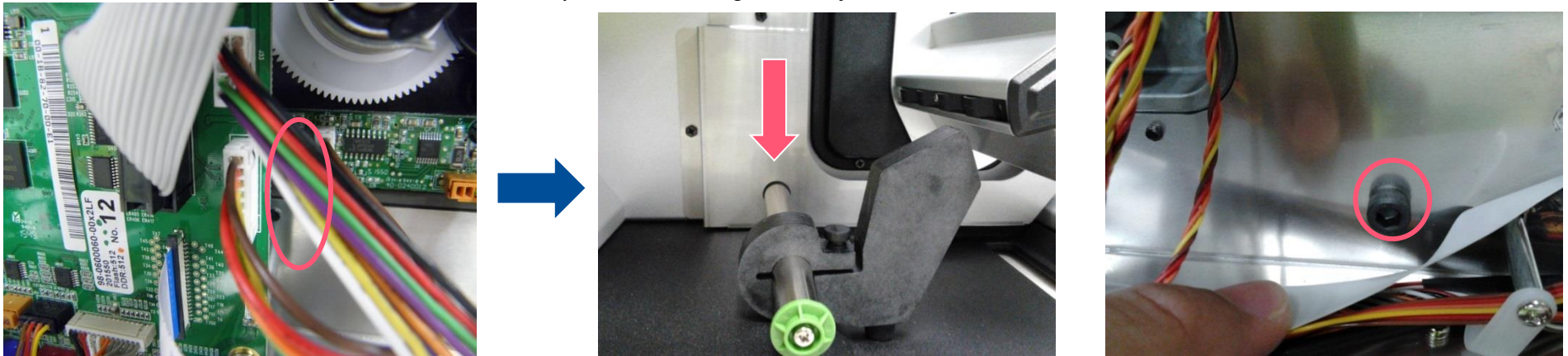

## 3.19 Replacing WiFi Housing

1. Refer to section 3.2 to remove the electronics cover.
2. Take off the housing cover by removing 2 screws on rear of printer.
3. Remove 2 screws on slot-in housing.

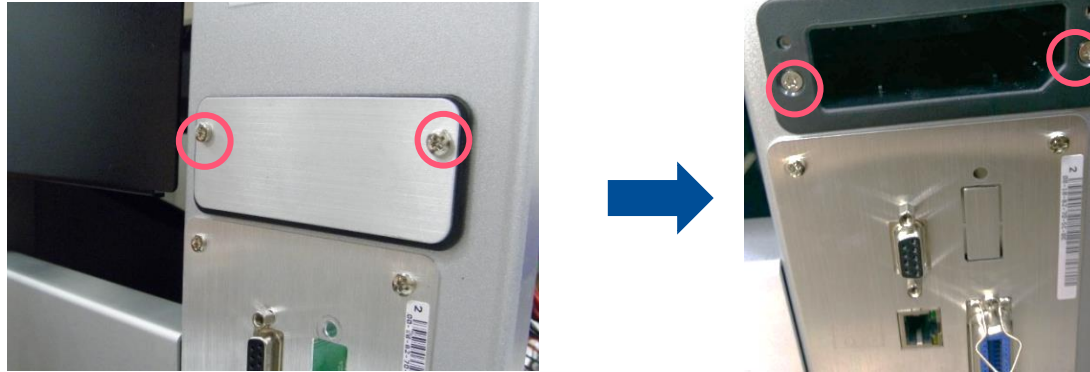

4. Disconnect the transfer board connector on the main board to replacing it.
5. Take out the housing.

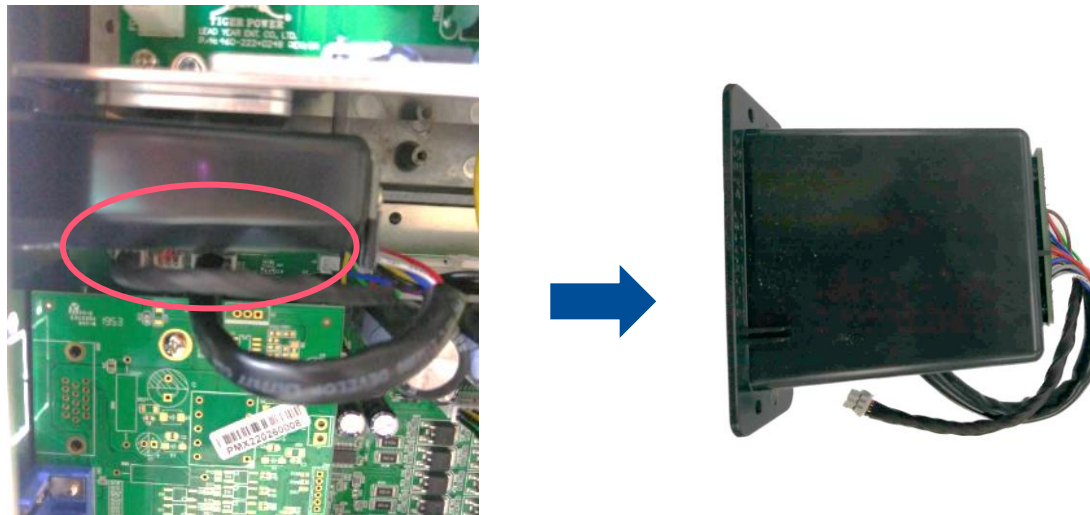

6. Reassemble the part in reverses procedures.

## 3.20 Install WiFi+BT Combo Module

1. Make sure the housing has been install on the printer.
2. If not, please refer 3.19 to install the wifi housing.
3. Insert the Wifi+BT module and tighten the 2 screws



4. Remove the parts in reverse procedures.



# 4. Troubleshooting

Problem	Possible Cause	Recovery Procedure
<b>Power indicator does not illuminate</b>	<ul style="list-style-type: none"> <li>The power cord is not properly connected.</li> <li>The power switch is closed.</li> </ul>	<ul style="list-style-type: none"> <li>Plug the power cord in printer and outlet.</li> <li>Switch the printer on.</li> </ul>
<b>Carriage Open</b>	<ul style="list-style-type: none"> <li>The printer carriage is open.</li> </ul>	<ul style="list-style-type: none"> <li>Close the print carriage.</li> </ul>
<b>Not Printing</b>	<ul style="list-style-type: none"> <li>Check if interface cable is well connected.</li> <li>Check if wireless or Bluetooth device is well connected.</li> <li>The port in the Windows driver is not correct.</li> </ul>	<ul style="list-style-type: none"> <li>Re-connect cable to interface or change a new cable.</li> <li>Reset the wireless device setting.</li> <li>Select the correct printer port in the driver.</li> <li>Clean the printhead.</li> <li>Printhead's harness connector is not well connected with printhead. Turn off the printer and plug the connector again.</li> <li>Check your program if there is a command - PRINT at the end of the file and there must have CRLF at the end of each command line.</li> </ul>
<b>No print on the label</b>	<ul style="list-style-type: none"> <li>Label or ribbon is loaded not correctly.</li> <li>Use wrong type paper or ribbon</li> </ul>	<ul style="list-style-type: none"> <li>Follow the instructions in loading the media and ribbon.</li> <li>Ribbon and media are not compatible.</li> <li>Verify the ribbon-inked side.</li> <li>The print density setting is incorrect.</li> </ul>
<b>No Ribbon</b>	<ul style="list-style-type: none"> <li>Running out of ribbon.</li> <li>The ribbon is installed incorrectly.</li> </ul>	<ul style="list-style-type: none"> <li>Supply a new ribbon roll.</li> <li>Refer to user's manual to reinstall the ribbon.</li> </ul>
<b>No Paper</b>	<ul style="list-style-type: none"> <li>Running out of label.</li> <li>The label is installed incorrectly.</li> <li>Gap/black mark sensor is not calibrated.</li> </ul>	<ul style="list-style-type: none"> <li>Supply a new label roll.</li> <li>Refer to user's manual to reinstall the label roll.</li> <li>Calibrate the gap/black mark sensor.</li> </ul>
<b>Paper Jam</b>	<ul style="list-style-type: none"> <li>Gap/black mark sensor is not set properly.</li> <li>Make sure label size is set properly.</li> <li>Labels may be stuck inside the printer</li> </ul>	<ul style="list-style-type: none"> <li>Calibrate the media sensor.</li> <li>Set media size correctly.</li> <li>Remove the stuck label inside the printer mechanism.</li> </ul>

mechanism.

#### Take Label

- Peel function is enabled.
- If peeler module is installed, please remove the label.
- If there is no peeler module in front of the printer, please switch off the printer and install it.
- Check if the connector is plugging correctly.

#### Can't downloading the file to memory (FLASH / DRAM/CARD)

- The space of memory is full.
- Delete unused files in the memory.

#### Poor Print Quality

- Ribbon and media is loaded incorrectly.
- Dust or adhesive accumulation on the print head.
- Print density is not set properly.
- Printhead element is damaged.
- Ribbon and media are incompatible.
- The printhead pressure is not set properly.
- Reload the supply.
- Clean the print head.
- Clean the platen roller.
- Adjust the print density and print speed.
- Run printer self-test and check the print head test pattern if there is dot missing in the pattern.
- Change proper ribbon or proper label media.
- Adjust the printhead pressure adjustment knob.
- The release lever does not latch the printhead properly.

#### Missing printing on the left or right side of label

- Wrong label size setup.
- Set the correct label size.

#### Gray line on the blank label

- The print head is dirty.
- The platen roller is dirty.
- Clean the print head.
- Clean the platen roller.
- (Please refer to chapter 8)

#### Irregular printing

- The printer is in Hex Dump mode.
- The RS-232 setting is incorrect.
- Turn off and on the printer to skip the dump mode.
- Re-set the RS-232 setting.

#### Label feeding is not stable (skew) when printing

- The media guide does not touch the edge of the media.
- If the label is moving to the right side, please move the label guide to left.
- If the label is moving to the left side, please move the label guide to right.

#### Skip labels when printing

- Label size is not specified properly.
- Check if label size is setup correctly.

	<ul style="list-style-type: none"> <li>■ Sensor sensitivity is not set properly.</li> <li>■ The media sensor is covered with dust.</li> </ul>	<ul style="list-style-type: none"> <li>■ Calibrate the sensor by Auto Gap or Manual Gap options.</li> <li>■ Clear the GAP/Black mark sensor by blower.</li> </ul>
<b>Wrinkle Problem</b>	<ul style="list-style-type: none"> <li>■ Printhead pressure is incorrect.</li> <li>■ Ribbon installation is incorrect.</li> <li>■ Media installation is incorrect.</li> <li>■ Print density is incorrect.</li> <li>■ Media feeding is incorrect.</li> </ul>	<ul style="list-style-type: none"> <li>■ Please refer to the chapter 4.</li> <li>■ Please set the suitable density to have good print quality.</li> <li>■ Make sure the label guide touch the edge of the media guide.</li> </ul>
<b>RTC time is incorrect when reboot the printer</b>	<ul style="list-style-type: none"> <li>■ The battery has run down.</li> </ul>	<ul style="list-style-type: none"> <li>■ Check if there is a battery on the main board.</li> </ul>
<b>The left side printout position is incorrect</b>	<ul style="list-style-type: none"> <li>■ Wrong label size setup.</li> <li>■ The parameter Shift X in LCD menu is incorrect.</li> </ul>	<ul style="list-style-type: none"> <li>■ Set the correct label size.</li> <li>■ Press [Menu] → [Setting] → [Shift X] to fine tune the parameter of Shift X.</li> </ul>
<b>The printing position of small label is incorrect</b>	<ul style="list-style-type: none"> <li>■ Media sensor sensitivity is not set properly.</li> <li>■ Label size is incorrect.</li> <li>■ The parameter Shift Y in the LCD menu is incorrect.</li> <li>■ The vertical offset setting in the driver is incorrect.</li> </ul>	<ul style="list-style-type: none"> <li>■ Calibrate the sensor sensitivity again.</li> <li>■ Set the correct label size and gap size.</li> <li>■ Press [Menu] → [Setting] → [Shift Y] → to fine tune the parameter of Shift Y.</li> <li>■ Set the vertical offset in the driver if you're using BarTender.</li> </ul>
<b>LCD panel is dark and keys are not working</b>	<ul style="list-style-type: none"> <li>■ The cable between main PCB and LCD panel is loose.</li> </ul>	<ul style="list-style-type: none"> <li>■ Check if the cable between main PCB and LCD is secured or not.</li> </ul>
<b>LCD panel is dark but the LEDs are light</b>	<ul style="list-style-type: none"> <li>■ The printer initialization is unsuccessful.</li> </ul>	<ul style="list-style-type: none"> <li>■ Turn OFF and ON the printer again.</li> <li>■ Initialize the printer.</li> </ul>
<b>Ribbon encoder sensor doesn't work</b>	<ul style="list-style-type: none"> <li>■ The ribbon encoder sensor connector is loose.</li> </ul>	<ul style="list-style-type: none"> <li>■ Fasten the connector.</li> </ul>
<b>Ribbon end sensor doesn't work</b>	<ul style="list-style-type: none"> <li>■ The connector is loose.</li> <li>■ The ribbon sensor hole is covered with dust.</li> </ul>	<ul style="list-style-type: none"> <li>■ Check the connector.</li> <li>■ Clear the dust in the sensor hole by the blower.</li> </ul>
<b>Cutter is not working</b>	<ul style="list-style-type: none"> <li>■ The connector is loose.</li> </ul>	<ul style="list-style-type: none"> <li>■ Plug in the connect cable correctly.</li> </ul>

## 4.1 Knob Adjustment

**Print Head Pressure Adjustment Knob** has 5 levels' adjustment. Different number means different pressure to the print head . Due to media is aligned to the inbound of the printer mechanism, different media width requires the different pressure. Users can try which level can meet their expectation.

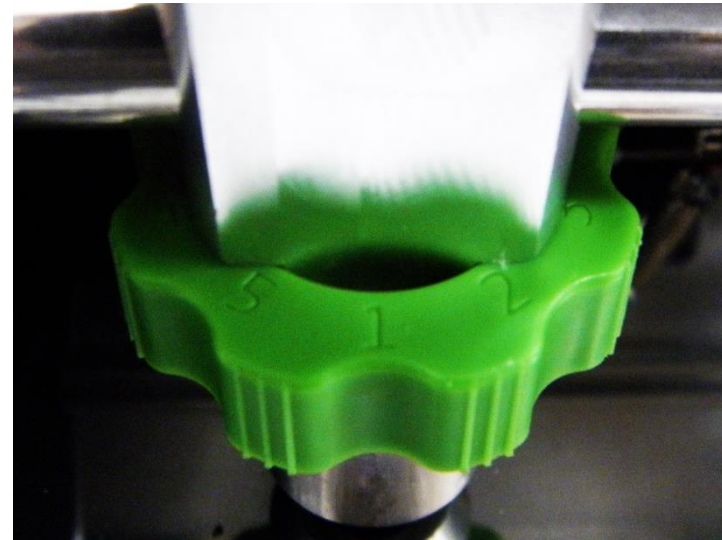
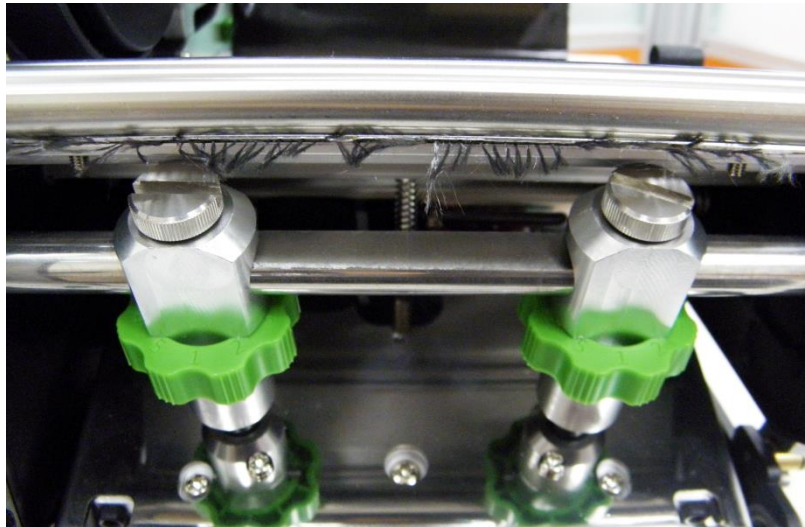

- **Pressure level: 5>4>3>2>1 (5 is the highest)**
- If the label width is 4", adjust both print head pressure to the same level.
- If the label is less than 2" wide, increase the pressure of left adjustment knob and decrease the right side pressure.

## 4.2 Mechanism Fine Adjustment to Avoid Ribbon Wrinkles

**Ribbon wrinkle** is related to the media width, thickness, print head pressure balance, ribbon film characteristics, print darkness setting...etc. In case the ribbon wrinkle happens, please follow the instructions below to adjust the printer parts.



## Wrinkle happens from label lower left to upper right direction

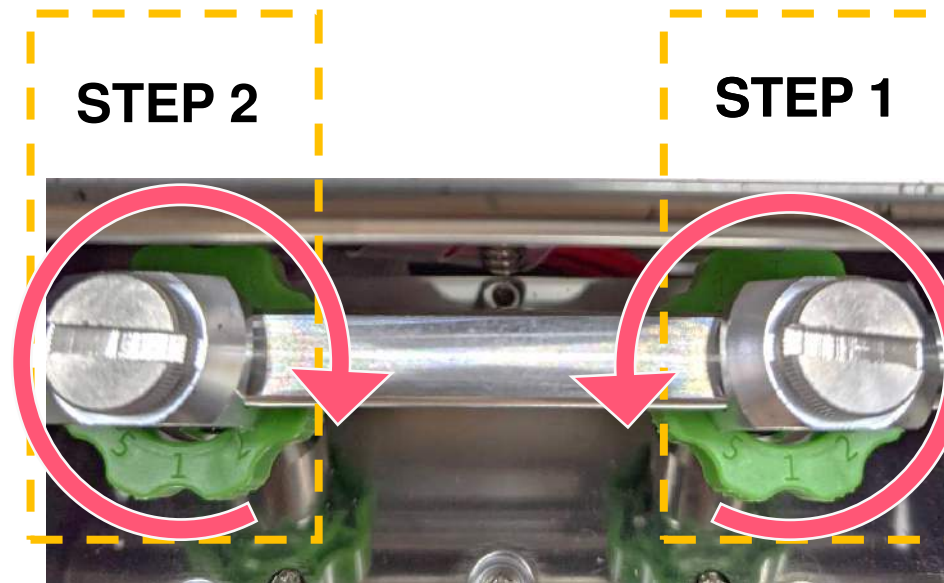

Pressure level: 5>4>3>2>1 (5 is the highest)

- **Step 1** Decrease the right side's pressure per level to check whether wrinkles is gone. adjustment knob.
- **Step 2** If right side pressure knob has been turned to level 1, but the wrinkle still exists, increase the left side pressure knob per level to check whether the wrinkle has been disappeared or not..

## Wrinkle happens from label lower right to upper left direction

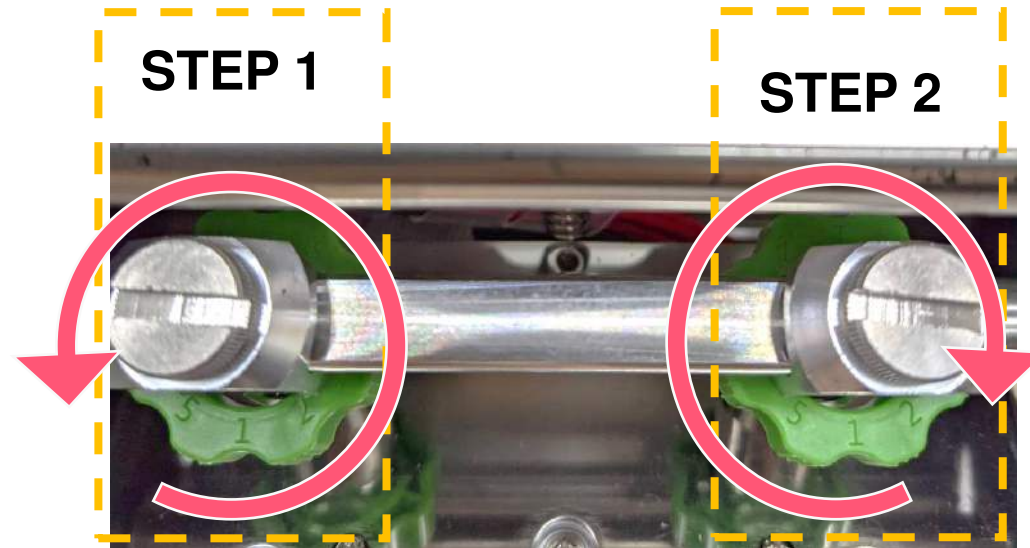

Pressure level: 5>4>3>2>1 (5 is the highest)

- **Step 1** Decrease the left side's pressure per level to check whether wrinkles is gone. adjustment knob.
- **Step 2** If right side pressure knob has been turned to level 1, but the wrinkle still exists, increase the left side pressure knob per level to check whether the wrinkle has been disappeared or not..

## 4.3 Suggestion of Ribbon Tension Adjustment

### For 4" width ribbon

If the ribbon width is 4", adjust both ribbon tension adjustment knobs to the #1 on ribbon supply & rewind spindles. (Factory default ribbon tension is #1)

**Ribbon Rewind Spindle Tension # 1**

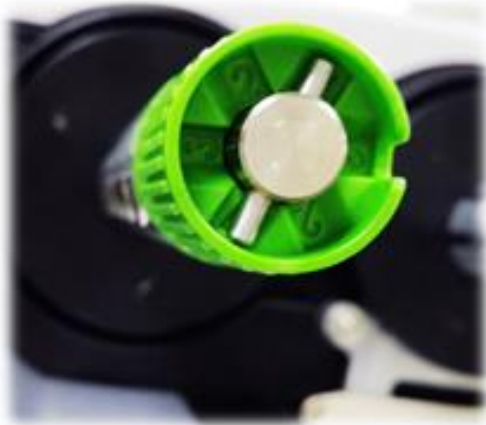

**Ribbon Supply Spindle Tension # 1**

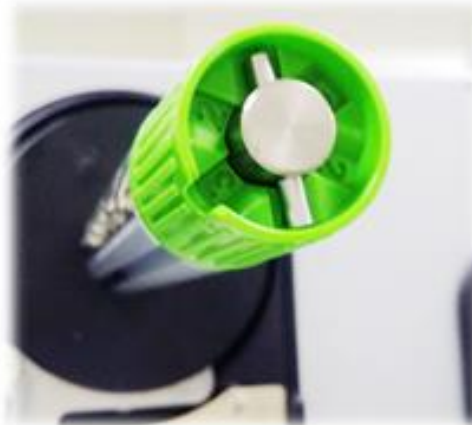



**For 3" width ribbon**

If the ribbon width is 3", adjust both ribbon tension adjustment knobs to the #2 on ribbon supply & rewind spindles.

**Ribbon Rewind Spindle Tension # 2**



**Ribbon Supply Spindle Tension # 2**



**For 2" width ribbon**

If the ribbon width is 2", adjust both ribbon tension adjustment knobs to the #3 on ribbon supply & rewind spindles.

**Ribbon Rewind Spindle Tension # 3**



**Ribbon Supply Spindle Tension # 3**



# 5. Maintenance

This session presents the clean tools and methods to maintain the printer.

## ■ For Cleaning

Depending on the media used, the printer may accumulate residues (media dust, adhesives, etc.) as a by-product of normal printing. To maintain the best printing quality, you should remove these residues by cleaning the printer periodically. Regularly clean the print head and supply sensors once change a new media to keep the printer at the optimized performance and extend printer life.

## ■ For Disinfecting

Sanitize your printer to protect yourself and others and can help prevent the spread of viruses.

## ■ Important

- Set the printer power switch to O (Off) prior to performing any cleaning or disinfecting tasks. Leave the power cord connected to keep the printer grounded and to reduce the risk of electrostatic damage.
- Do not wear rings or other metallic objects while cleaning any interior area of the printer.
- Use only the cleaning agents recommended in this document. Use of other agents may damage the printer and void its warranty.
- Do not spray or drip liquid cleaning solutions directly into the printer. Apply the solution on a clean lint-free cloth and then apply the dampened cloth to the printer.
- Do not use canned air in the interior of the printer as it can blow dust and debris onto sensors and other critical components.
- Only use a vacuum cleaner with a nozzle and hose that are conductive and grounded to drain off static build up.
- All reference in these procedures for use of isopropyl alcohol requires that a 99% or greater isopropyl alcohol content be used to reduce the risk of moisture corrosion to the printhead.
- Do not touch printhead by hand. If you touch it carelessly, please use 99% Isopropyl alcohol to clean it.
- Always taking personal precaution when using any cleaning agent.

## Cleaning Tools

- Cotton swab
- Lint-free cloth
- Brush with soft non-metallic bristles
- Vacuum cleaner
- 75% Ethanol (for disinfecting)
- 99% Isopropyl alcohol (for printhead and platen roller cleaning)
- Genuine printhead cleaning pen
- Mild detergent (without chlorine)

## Cleaning Process:

Printer Part	Method	Interval
<b>Print Head</b>	<ol style="list-style-type: none"> <li>I. Always turn off the printer before cleaning the printhead.</li> <li>II. Allow the printhead to cool for at least one minute.</li> <li>III. Use a cotton swab and 99% Isopropyl Alcohol or genuine print head cleaning pen to clean the print head surface.</li> </ol>	Clean the print head when changing a new label roll.
<b>Platen Roller</b>	<ol style="list-style-type: none"> <li>I. Turn off the printer.</li> <li>II. Rotate the platen roller and wipe it thoroughly with the lint-free 99% Isopropyl Alcohol.</li> </ol>	Clean the platen roller when changing a new label roll
<b>Peel Bar</b>	Use the lint-free cloth with 99% Isopropyl Alcohol to wipe it.	As needed
<b>Sensor</b>	Use brush with soft non-metallic bristles or a vacuum cleaner, to remove paper dust. Clean upper and lower media sensors to ensure reliable Top of Form and Paper Out sensing.	Monthly
<b>Exterior</b>	Clean the exterior surfaces with a clean, lint-free cloth (water-dampened cloth). If necessary, use a mild detergent or desktop cleaning solution then use the 75% Ethanol to wipe it.	As needed
<b>Interior</b>	Clean the interior of the printer by removing any dirt and lint with a vacuum cleaner, as described above, or use a brush with soft non-metallic bristles then use the 75% Ethanol to wipe it.	As needed

# Revise History

Date	Content	Editor
------	---------	--------

**TSC** **PRINTRONIX<sup>®</sup>**  
**AUTO ID**