

# TE200 Series

■ Thermal Transfer ■ Direct Thermal  
Desktop Barcode Printers



Series Lists:

TE200 / TE300

TE210 / TE310

# User Manual

# Copyright information

©2021 TSC Auto ID Technology Co., Ltd.

The copyright in this manual, the software and firmware in the printer described are owned by TSC Auto ID Technology Co., Ltd. All rights reserved.

CG Triumvirate is a trademark of Agfa Corporation. CG Triumvirate Bold Condensed font is under license from the Monotype Corporation. Windows is a registered trademark of Microsoft Corporation.

All other trademarks are the property of their respective owners. Information in this document is subject to change without notice and does not represent a commitment on the part of TSC Auto ID Technology Co. No part of this manual may be reproduced or transmitted in any form or by any means, for any purpose other than the purchaser's personal use, without the expressed written permission of TSC Auto ID Technology Co.



# Table of Contents

1. Introduction .....	1
1.1 Product Specification .....	2
1.1.1 Printer Optional Features .....	4
1.1.2 Label Print Module Features (Optional) .....	5
1.2 General Specification .....	6
1.3 Print Specification .....	7
1.4 Ribbon Specification .....	7
1.5 Media Specification .....	8
2. Operation Overview .....	9
2.1 Unpacking and Inspection .....	9
2.2 Printer Overview .....	10
2.2.1 Front View .....	10
2.2.2 Interior View .....	11
2.3.2 Rear View .....	12
3. Setup .....	13
3.1 Setting up the Printer .....	13
3.2 Loading the Ribbon .....	14
3.3 Loading the Media .....	17
3.4 External Label Roll Mount Installation (Option) .....	20
3.5 Loading Label in Peel-Off Mode (Option) .....	21
3.6 Loading Label in Cutter Mode (Option) .....	22
3.7 Loading Label in Peeler Mode (Option) .....	23
4. LED and Button Functions .....	24



4.1 LED Indicator .....	24
4.2 Regular Button Function .....	24
4.3 Power-on Utilities .....	25
5. TSC Console .....	26
5.1 Start TSC Console .....	26
5.2 Setup Ethernet Interface .....	28
5.3 Set WiFi and Add to TSC Console Interface .....	30
5.4 Initialize the Printer WiFi Setting .....	33
5.5 TPH Care .....	34
5.6 Printer Function .....	35
5.7 Setting Post-Print Action .....	36
6. Troubleshooting .....	37
7. Maintenance .....	40
8. Agency Compliance and Approvals .....	42
9. Revision History .....	53



# 1. Introduction

Thank you very much for purchasing TSC bar code printer.

The TE200/TE210/TE300/TE310 series printer features the single motor that is capable of handling a large capacity of 300 meters ribbon and large rolls of media inside its sleek design. If the 5" interior label capacity is not enough, simply adding an external media roll mount and the TE series can easily handle 8" OD rolls of labels designed for expensive industrial label printers.

To meet the various printing requirements, TE200/TE300 and TE210/TE310 series provides different memory capacity. Moreover, TE210/TE310 series have optional peel-off and cutter kits for users to purchase. The movable black mark sensor design can accept a wide range of label media. All of the most frequently used bar code formats are included. Fonts and bar codes can be printed in any one of the four directions.

This document provides an easy reference for operating this printer. For system integration, the TSPL/TSPL2 printer programming manual or SDKs can be found on TSC website at: <https://www.tscprinters.com>.

## 1.1 Product Specification

Product standard feature	TE200 (203 dpi model)	TE300 (300 dpi model)	TE210 (203 dpi model)	TE310 (300 dpi model)
Thermal transfer printing	<input type="radio"/>	<input type="radio"/>	<input type="radio"/>	<input type="radio"/>
Direct thermal printing	<input type="radio"/>	<input type="radio"/>	<input type="radio"/>	<input type="radio"/>
Plastic	<input type="radio"/>	<input type="radio"/>	<input type="radio"/>	<input type="radio"/>
Gap sensor	<input type="radio"/>	<input type="radio"/>	<input type="radio"/>	<input type="radio"/>
Reflective, full-range moveable black mark sensor	<input type="radio"/>	<input type="radio"/>	<input type="radio"/>	<input type="radio"/>
Ribbon sensor	<input type="radio"/>	<input type="radio"/>	<input type="radio"/>	<input type="radio"/>
Head open sensor	<input type="radio"/>	<input type="radio"/>	<input type="radio"/>	<input type="radio"/>
USB 2.0 (Hi-Speed) interface	<input type="radio"/>	<input type="radio"/>	<input type="radio"/>	<input type="radio"/>
16 MB DRAM memory	<input type="radio"/>	<input type="radio"/>	-	-
64 MB DRAM memory	-	-	<input type="radio"/>	<input type="radio"/>
8 MB Flash memory	<input type="radio"/>	<input type="radio"/>	-	-

128 MB Flash memory	-	-	○	○
SD card reader (Reserve a PIN connector for updating firmware by card when doing maintenance.)	-	-	-	-
RTC	-	-	○	○
BUZZER	-	-	○	○
One button for feed and pause	○	○	○	○
One LED indicator for 3 colors	○	○	○	○
Standard industry emulations right out of the box including Eltron® and Zebra® language support	○	○	○	○
Internal 8 alpha-numeric bitmap fonts	○	○	○	○
Fonts and bar codes can be printed in any one of the four directions (0, 90,180, 270 degrees)	○	○	○	○
Internal Monotype Imaging® true type font engine with one CG Triumvirate Bold Condensed scalable font	○	○	○	○
Downloadable fonts from PC to printer memory	○	○	○	○
Text, bar code, graphics/image printing (Please refer to the TSPL/TSPL2 programming manual for supporting code page)	○	○	○	○

## 1.1.1 Printer Optional Features

The printer offers the following optional features.

Product option feature	User options	Dealer options	Factory options
Extended plate for external roll mount assembly with 3" core label spindle (8.4 OD)	<input type="radio"/>		
Internal Bluetooth v4.0			<input type="radio"/>
<b>For TE210/TE310 Series only:</b>			
KP-200 Plus (with RS-232 interface)	<input type="radio"/>		
External BT module (with RS-232 interface)	<input type="radio"/>		
Peeler module		<input type="radio"/>	
Regular full cut cutter (Guillotine cutter) Media thickness: 0.06~0.19 mm Media type: receipt and label liner w/o glue		<input type="radio"/>	
Regular full/partial cutter (Guillotine cutter) Media thickness: 0.06~0.19 mm Media type: receipt and label liner w/o glue		<input type="radio"/>	
Internal Wi-Fi module			<input type="radio"/>



## 1.1.2 Label Print Module Features (Optional)

<b>Print Module</b>	Resolution	8 dots/mm (203 DPI)	12 dots/mm (300 DPI)
	Max. print speed	152.4 mm (6")/second	127 mm (5")/second
	Max. print width	108 mm (4.25")	105.7 mm (4.16")
	Physical dimension	196.0 mm (W) x 161.0 mm (L) x 145.0 mm (H) (7.72" (W) x 6.34" (L) x 5.71" (H))	
	Weight	1.43 kg (3.15 lbs)	
<b>Platform</b>	Memory	128 MB Flash memory, 64 MB SDRAM	
	Interface	USB2.0, RS-232, Internal Ethernet 10/100 Mbps, USB host	
	Real time clock	Option	
	Buzzer	Standard	
<b>Power Supply</b>	Input	AC 100-240V, 2.5A, 50-60Hz	
	Output	DC 24V, 2.5A, 60W	
<b>Supported Media</b>	Media type	Continuous, black mark, die-cut, notched, fan-fold	
	Media wound type	Outside wound	
	Media width	20 ~ 112 mm (0.8" ~ 4.4")	
	Min. media length	5 mm (0.2")	
	Media thickness	0.06mm ~ 0.19 mm (2.36 ~ 7.48 mil)	
<b>Support Ribbon</b>	Ribbon type	WAX, RESIN, WAX-RESIN	
	Wound type	Outside wound	
	Ribbon width	40 ~ 110 mm (1.6" ~ 4.3")	
	Ribbon capacity	300 m long, max. OD 67 mm, 1" core (ink coated outside) 110 m long, max. OD 40 mm, 0.5" core (ink coated outside)	
<b>Accessory</b>	Standard	<ul style="list-style-type: none"> <li>■ 1" label spindle, fixing tab x 2, 1.5" adapter x 2</li> <li>■ 1" ribbon spindle x 2 for 300M ribbon</li> <li>■ 1" ribbon paper core</li> </ul>	

	Optional	<ul style="list-style-type: none"> <li>■ Peel-off module</li> <li>■ Guillotine cutter (full cut and partial cut)</li> <li>■ External roll mount, media OD. 214 mm (8.4") with 76.2 mm (3") core</li> </ul>
--	----------	--

## 1.2 General Specification

### TE200/TE300

### TE210/TE310

<b>Physical dimensions</b>	204 mm (W) x 164 mm (H) x 280 mm (L)	
<b>Weight</b>	2.4kg	2.5kg
<b>Electrical</b>	External universal switching power supply Input: AC 100-240V, 2A, 50-60 Hz Output: DC 24V, 2.5A, 60W, LPS	
<b>Environmental condition</b>	Operation: 5 ~ 40°C (41 ~ 104°F), 25~85% non-condensing Storage: -40 ~ 60 °C (-40 ~ 140°F), 10~90% non-condensing	

## 1.3 Print Specification

Print Specifications	TE200 (203 dpi model)	TE300 (300 dpi model)	TE210 (203 dpi model)	TE310 (300 dpi model)
Print head resolution	203 dots/inch (8 dots/mm)	300 dots/inch (12 dots/mm)	203 dots/inch (8 dots/mm)	300 dots/inch (12 dots/mm)
Printing method	Thermal transfer and direct thermal			
Dot size (width x length)	0.125 x 0.125 mm (1 mm = 8 dots)	0.084 x 0.084 mm (1 mm = 11.8 dots)	0.125 x 0.125 mm (1 mm = 8 dots)	0.084 x 0.084 mm (1 mm = 11.8 dots)
Print speed (inches per second)	Up to 6 ips	Up to 5 ips	Up to 6 ips	Up to 5 ips
Print speed for peel mode	N/A		Up to 3 ips	
Max. print width	108 mm (4.25")	105.7 mm (4.16")	108 mm (4.25")	105.7 mm (4.16")
Max. print length	2,794 mm (110")	1,016 mm (40")	25,400 mm (1000")	11,430 mm (450")

## 1.4 Ribbon Specification

### Ribbon Specifications

Ribbon outside diameter	1" core: Max. 67mm
Ribbon length	0.5" core: Max. 40mm
Ribbon length	1" inner core: 300 meters
Ribbon width	0.5" inner core: 110 meters
Ribbon core inside diameter	0.5 and 1 inch

## 1.5 Media Specification

	TE200 (203 dpi model)	TE300 (300 dpi model)	TE210 (203 dpi model)	TE310 (300 dpi model)
<b>Label roll capacity</b>	Max. 5" OD			
<b>Media type</b>	Continuous, die-cut, black mark, fan-fold, notch			
<b>Media wound type</b>	Outside wound			
<b>Media width</b>	20mm ~ Max. 112 mm			
<b>Media thickness</b>	0.06 mm (2.36 mil) ~ 0.19 mm (7.48 mil)			
<b>Media core diameter</b>	1" (25.4 mm) & 1.5" (38 mm) ID core			
<b>Label length</b>	5 mm ~ Max. printing length			
<b>Label length (peeler mode)</b>	N/A		1" ~ 6" (25.4 ~ 152.4 mm)	
<b>Label length (cutter mode)</b>	N/A		1" ~ Max. printing length	
<b>Gap height</b>	Min. 2 mm (0.09")			
<b>Black mark height</b>	Min. 2 mm (0.09")			
<b>Black mark width</b>	Min. 8 mm (0.31")			

## 2. Operation Overview

### 2.1 Unpacking and Inspection

This printer has been specially packaged to withstand damage during shipping. Please carefully inspect the packaging and printer upon receiving the bar code printer. Please retain the packaging materials in case you need to reship the printer.

- One printer unit
- One quick installation guide
- One power cord
- One external universal switching power supply
- One USB interface cable
- A pair of 1" Ribbon spindles for 300M ribbon
- One 1" ribbon paper core
- One label spindle with two fixing tabs and two 1.5" adapters

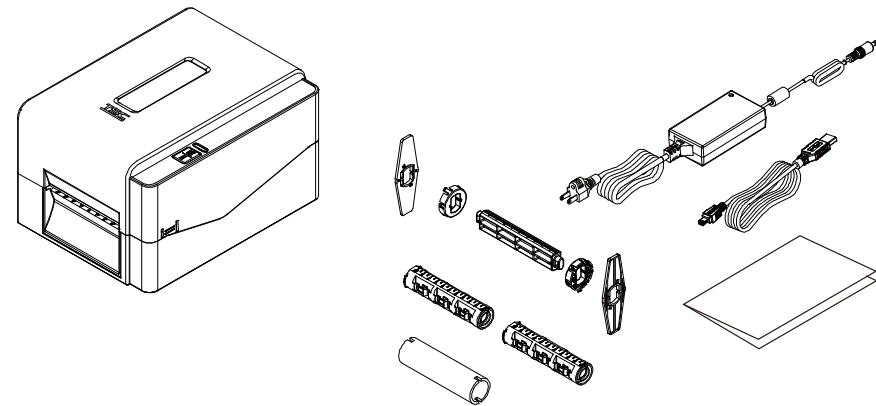

**If any parts are missing, please contact the Customer Service Department of your purchased reseller or distributor.**

## 2.2 Printer Overview

### 2.2.1 Front View



1. Paper exit chute
2. LED indicator
3. Feed/Pause button
4. Top cover open tab

## 2.2.2 Interior View

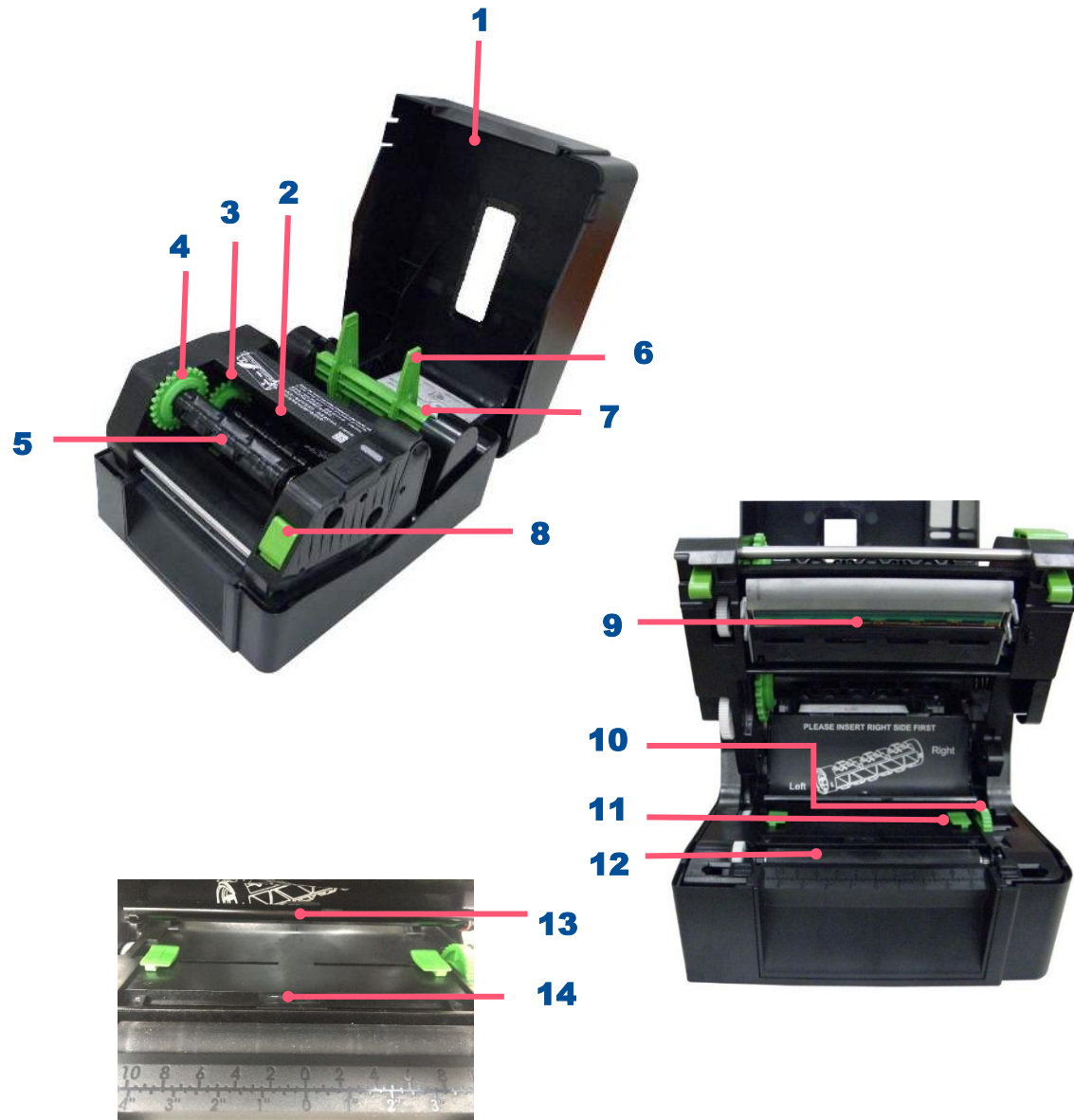

1. Printer top cover
2. Ribbon supply spindle
3. Ribbon supply hub
4. Ribbon rewind hub
5. Ribbon rewind spindle
6. Fixing tabs
7. Media supply spindle
8. Print head release button
9. Print head
10. Media guide adjustment knob
11. Media guide
12. Platen roller
13. Gap sensor
14. Black mark sensor

## 2.3.2 Rear View

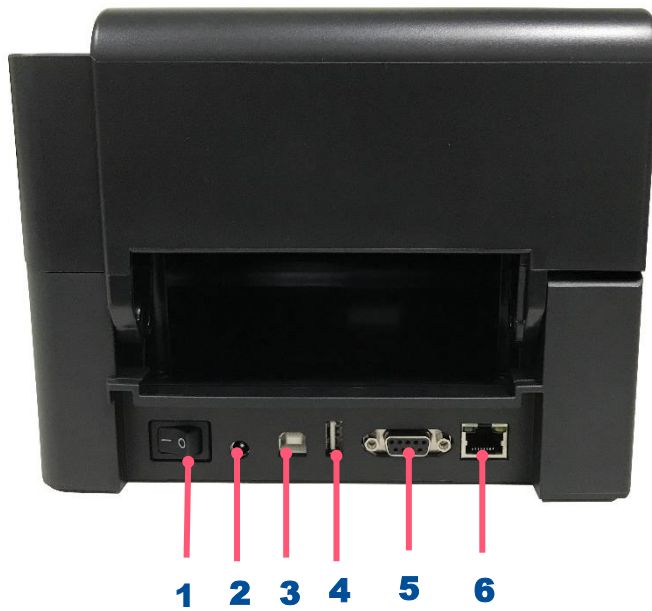

1. Power switch
2. Power jack socket
3. USB interface (USB 2.0/Hi-Speed mode)
4. USB host (TE210/TE310 Series only)
5. RS-232 interface (TE210/TE310 Series only)
6. Ethernet interface (TE210/TE310 Series only)



# 3. Setup

## 3.1 Setting up the Printer

1. Plug the power cord into the AC power cord socket at the rear of the printer. Then, plug the other side into a properly grounded power outlet.
2. Connect the printer to the computer with the provided USB cable.
3. Push the power switch on “-” side to open the power of printer.
4. If you would like to watch printer installation videos, please scan the QR code on the right side for more information.

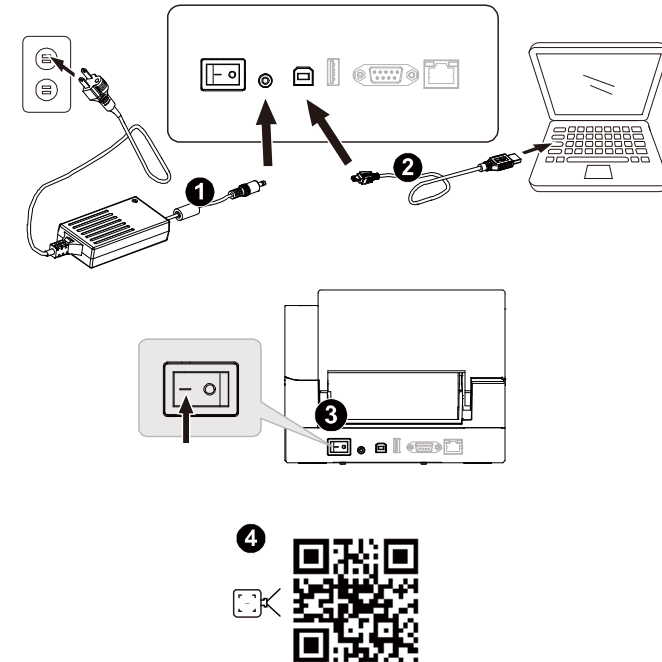

- ◆ **Note: Please switch OFF the printer before plugging in the power cord to printer power jack.**
- ◆ **\*The interface picture here is for reference only. Please refer to the product specification for the interface availability.**

## 3.2 Loading the Ribbon



1. Open the printer top cover by pressing the top cover open tabs and pulling up.



2. Open the ribbon access cover and the media cover. Insert the paper core to the ribbon rewind spindle.

**Note:** Please follow the direction when installing the ribbon rewind spindle.



3. Insert the right side of ribbon rewind spindle first. Then, insert the left side to the hole at the left side of ribbon rewind hub (green).

**Note:** It can also be substituted by 0.5- or 1-inch paper roll with notches on both sides. Please insert it at the ribbon rewind hub directly.

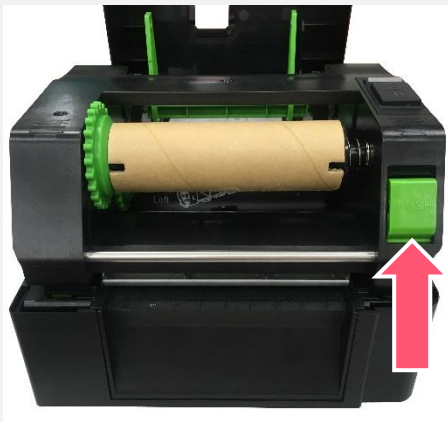

4. Push the print head release button to open the print head mechanism.



5. Insert the ribbon to the ribbon spindle.  
**Note:** The ribbon spindle can be substituted by insert the ribbon with notches on both sides to the ribbon mechanism directly.



6. Insert the right side of ribbon supply spindle (marked "R") to the ribbon supply hub first. Then, insert the left side of ribbon supply spindle to the hole at the left side of ribbon supply hub (green).

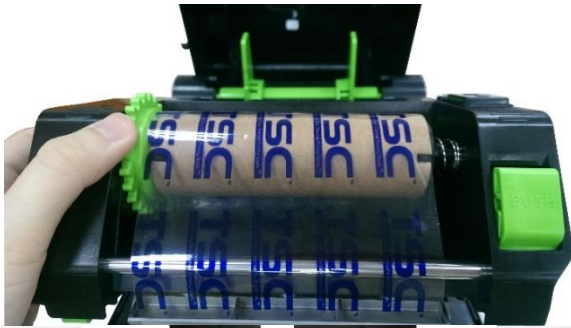

7. Pull the leader of the ribbon through the print head and stick the leader of the ribbon onto the ribbon rewind paper core.
8. Turn the ribbon rewind hub until the ribbon plastic leader is thoroughly wound and the black section of the ribbon covers the print head.



9. Close the print head mechanism with both hands and make sure the latches are engaged securely.

### Loading path for ribbon

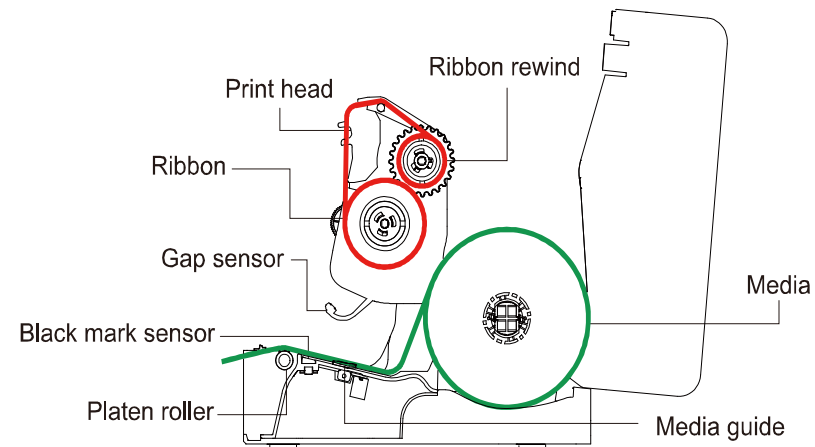

### 3.3 Loading the Media



1. Open the printer top cover by pressing the top cover open tabs located on each side of the printer.

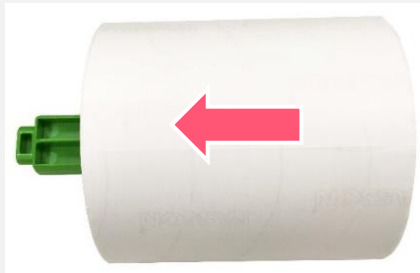

2. Insert the paper roll into the media supply spindle and use two fixing tabs to fix the paper roll onto the center of the spindle. (If paper width is 4", user could remove the fixing tabs on both side of the media supply spindle.)



3. Place the paper roll onto the paper roll mount. Media spindle attached with two fixing tabs and two 1.5" adapters



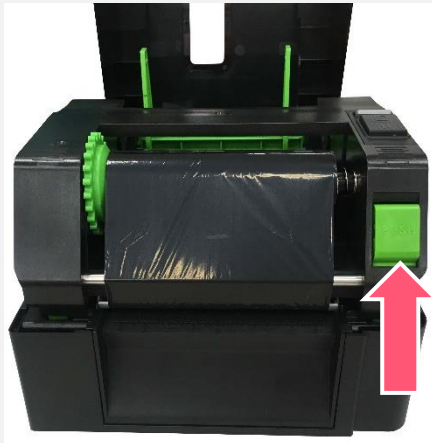

4. Push the print head release button to open the print head mechanism.

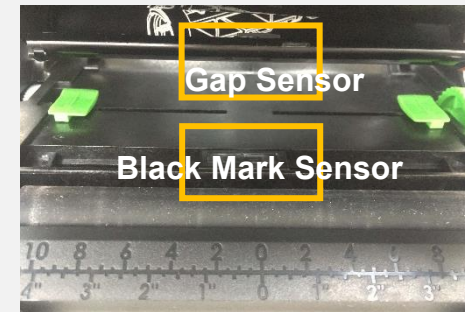

Note: The black mark sensor position is moveable and the gap sensor is fixed. Please make sure the gap or black mark is at the location where media gap/black mark will pass through for sensing.



5. Feed the paper, printing side face up, through the media sensor and place the label leading edge onto the platen roller. Move the media guides to fit the label width.

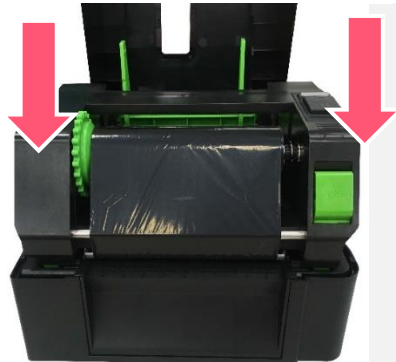

6. Close the print head mechanism with both hands and make sure the latches are engaged securely. Use hardware or software to set the media sensor type and calibrate the selected sensor. (Please refer to chapter 4 & 5.)

Loading path for Media

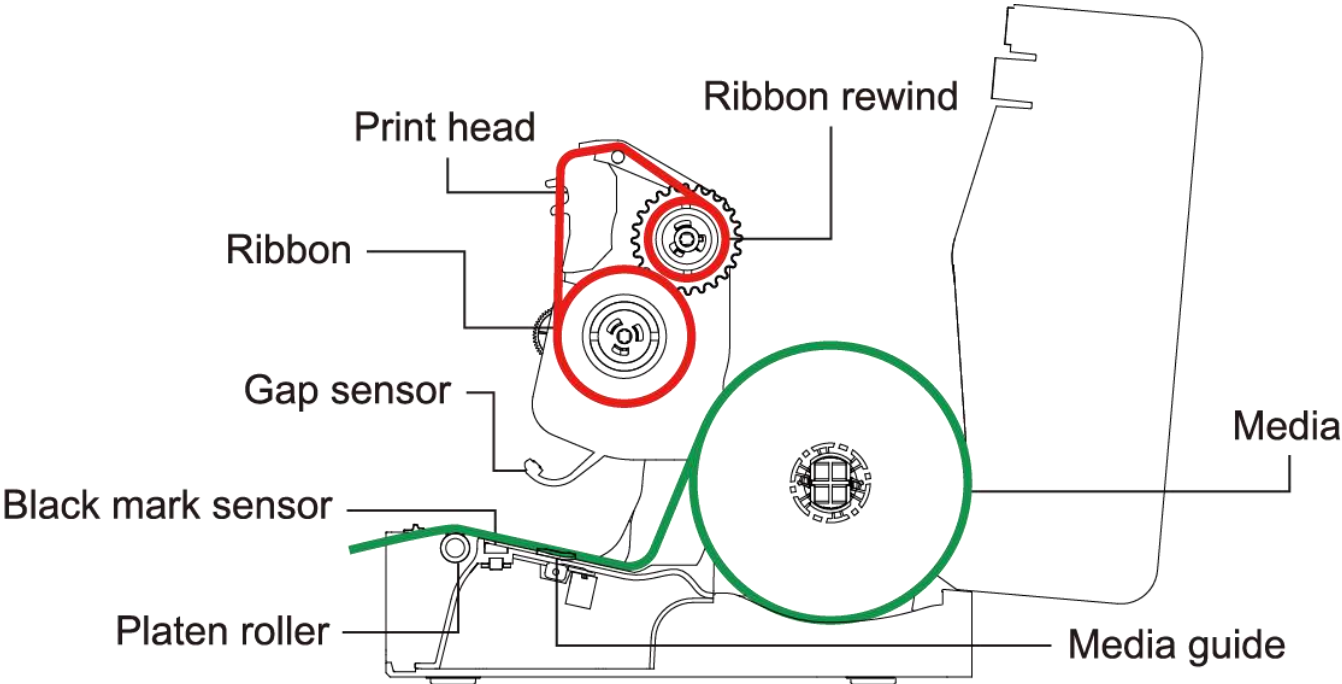

WARNING / ATTENTION  
HAZARDOUS MOVING PARTS. KEEP FINGERS AND OTHER BODY PARTS AWAY.  
PARTIES MOBILES DANGEREUSES. TENIR LES DOIGTS ET LES AUTRES PARTIES DU CORPS ÉLOIGNÉS.

**Note: Please calibrate the gap/ black mark sensor when changing media.**



### 3.4 External Label Roll Mount Installation (Option)



1. Attach an external paper roll mount on the bottom of the printer.



1" label spindle



2. Insert a 3" (or 1") label spindle into a paper roll. Then, install it on the external paper roll mount.



3. Feed the media through the rear external label entrance chute.



4. Refer to chapter 3.3 to install the label. Use software to set the media sensor type and calibrate the selected sensor. (Please refer to chapter 4.5)  
**Note:** Please calibrate the gap/black mark sensor when changing media.



### 3.5 Loading Label in Peel-Off Mode (Option)



1. Open the printer top cover and refer to chapter 3.3 to install the label.



2. Push the print head release button to open the print head mechanism and feed the media through the media sensor. Move the media guides to fit the label width.



3. Lead the media through the cutter paper opening.



4. Close the print head mechanism as indicated.



5. Close the peel-off module



6. Close the media cover and use software to make calibration then enable the peel mode. (Please refer to chapter 4&5)

## 3.6 Loading Label in Cutter Mode (Option)



1. Refer to chapter 3.3 to install the label and use software to set the media sensor type and calibrate the selected sensor.
2. Open the printer top cover by pressing the top cover open tabs located on each side of the printer.



3. Push the print head release button to open the print head mechanism and feed the media through the media sensor. Move the media guides to fit the label width.

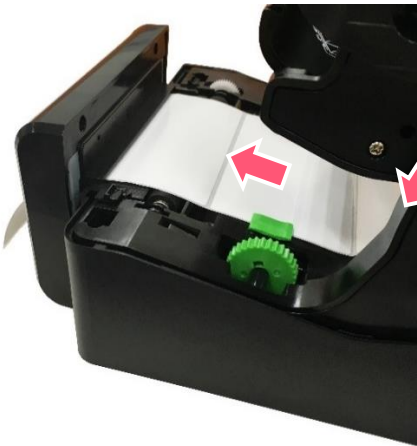

4. Lead the media through the cutter paper opening.



5. Close the print head mechanism as indicated.



6. Use software or menu function to enable the cutter mode. Press the FEED button to test.

### 3.7 Loading Label in Peeler Mode (Option)



1. Refer to chapter 3.3 to install the label. Use “TSC Console” to set the media sensor type and calibrate the selected sensor. Then open the printer top cover by pressing the top cover open tabs located on each side of the printer.



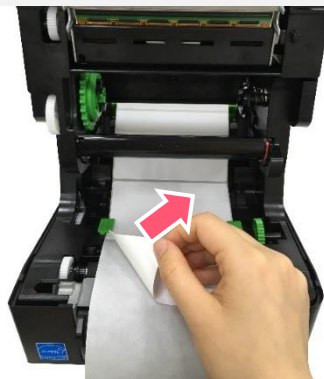

2. Push the print head release button to open the print head mechanism and feed the media through the media sensor. Move the media guides to fit the label width.



3. Feed the media through the rear external label entrance chute.

## 4. LED and Button Functions

### 4.1 LED Indicator

Color	Meaning
 (Green)	<b>Solid:</b> Power is on and ready to be used. <b>Flash:</b> System is downloading data or printer is paused.
 (Amber)	System is clearing data.
 (Red)	<b>Solid</b> - Printer head open, cutter error. <b>Flash</b> - Printing error, such as paper empty, paper jam, ribbon empty, or memory error etc.

### 4.2 Regular Button Function

**1. Feed labels**

When the printer is ready, press the button to feed one label to the beginning of next label.

**2. Pause the printing job**

When the printer is printing, press the button to pause a printing job. When the printer is paused, the LED will be green blinking. Press the button again to continue the printing job.

## 4.3 Power-on Utilities

**Power-on Utilities** provides the basic functions and can be activated by below procedures:

**Turn off** the power > **Hold** the FEED buttons > **Open** the power > **Release** the Feed button depending on the color of the LED.

Sequences of the settings:

LED Colors Functions	Amber	Red (5 blinks)	Amber (5 blinks)	Green (5 blinks)	Green / Amber (5 blinks)	Red / Amber (5 blinks)	Solid green
1. Sensor Calibration (Gap / black mark sensor)		Release					
2. Self-Test (And enter dump mode)			Release				
3. Factory Default				Release			
4. Bline Calibration					Release		
5. Gap Calibration						Release	
6. READY (Skip AUTO.BAS)							Release

# 5. TSC Console

TSC Console is a management tool combining the Printer Management, Diagnostic Tool, CommTool and Printer Webpage settings, which enables you to adjust printer's settings/status; change printers' settings; download graphics, deploy fonts, graphics, label templates or upgrade the firmware to the group of printers, and send additional commands to printers at the same time.

※ **Printer firmware version before A2.12 will only use 9100 Port as command port; Printer firmware after A2.12 will use 6101 Port as command port.**

## 5.1 Start TSC Console

1. Double click TSC Console icon to start the software.

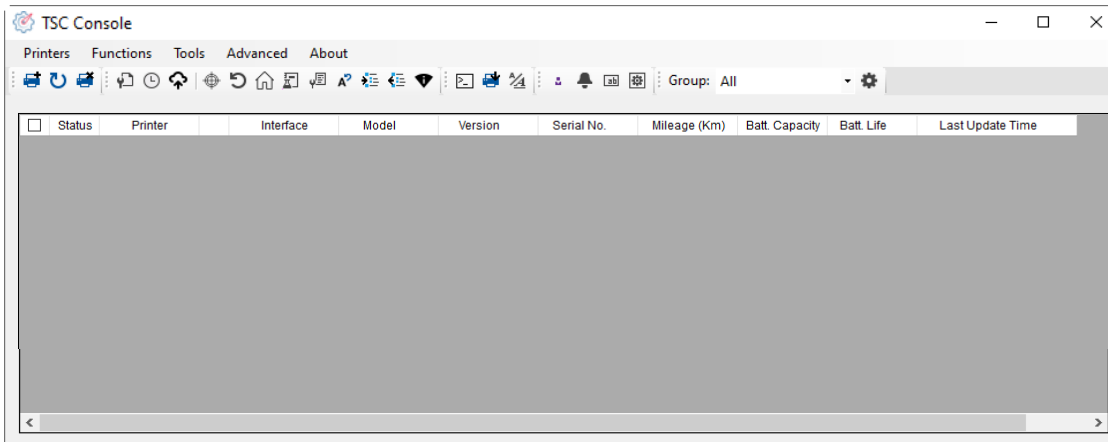

2. Manually add the devices by clicking **Printer > Add Printers**.

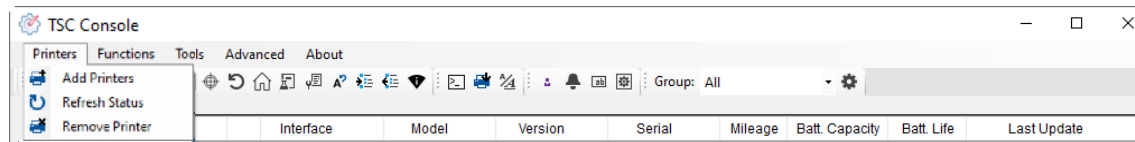

3. Select the current interface of the printer.

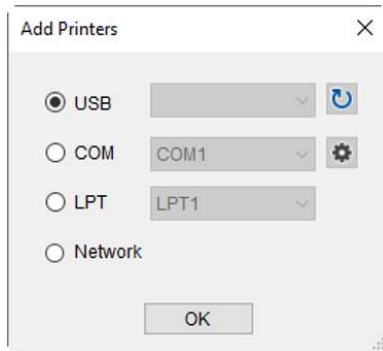

4. The printer will be added to **TSC Console**'s interface.

5. Select the printer and set the settings.

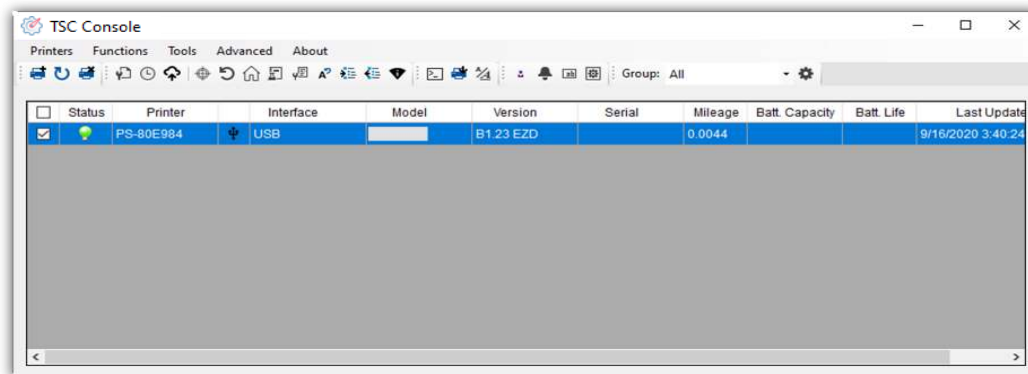

- For more information, please refer to **TSC Console User Manual**.

## 5.2 Setup Ethernet Interface

- Use **USB** or **COM** to establish the interface on **TSC Console**.

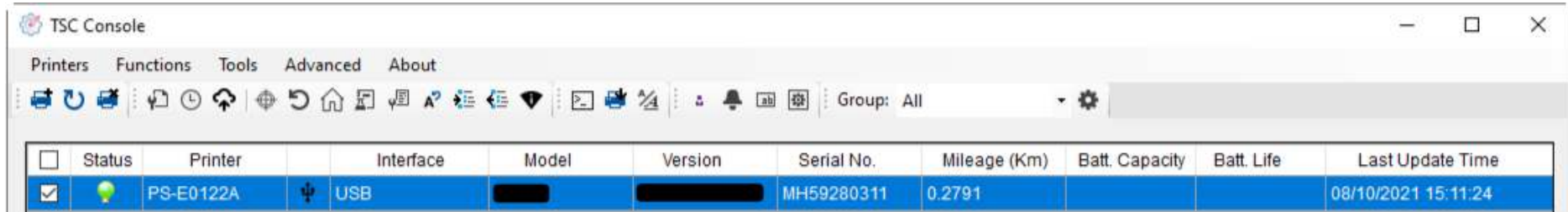

The screenshot shows the TSC Console application window. At the top, there are menu items: Printers, Functions, Tools, Advanced, and About. Below the menu is a toolbar with various icons. A status bar at the bottom of the window displays 'Group: All'. The main area contains a table with the following columns: Status, Printer, Interface, Model, Version, Serial No., Mileage (Km), Batt. Capacity, Batt. Life, and Last Update Time. The table has one row of data:

Status	Printer	Interface	Model	Version	Serial No.	Mileage (Km)	Batt. Capacity	Batt. Life	Last Update Time
<input checked="" type="checkbox"/>	PS-E0122A	USB			MH59280311	0.2791			08/10/2021 15:11:24

- Double click to enter the **Printer Configuration Page** > Click **Ethernet** tab > Check the **IP Address**.

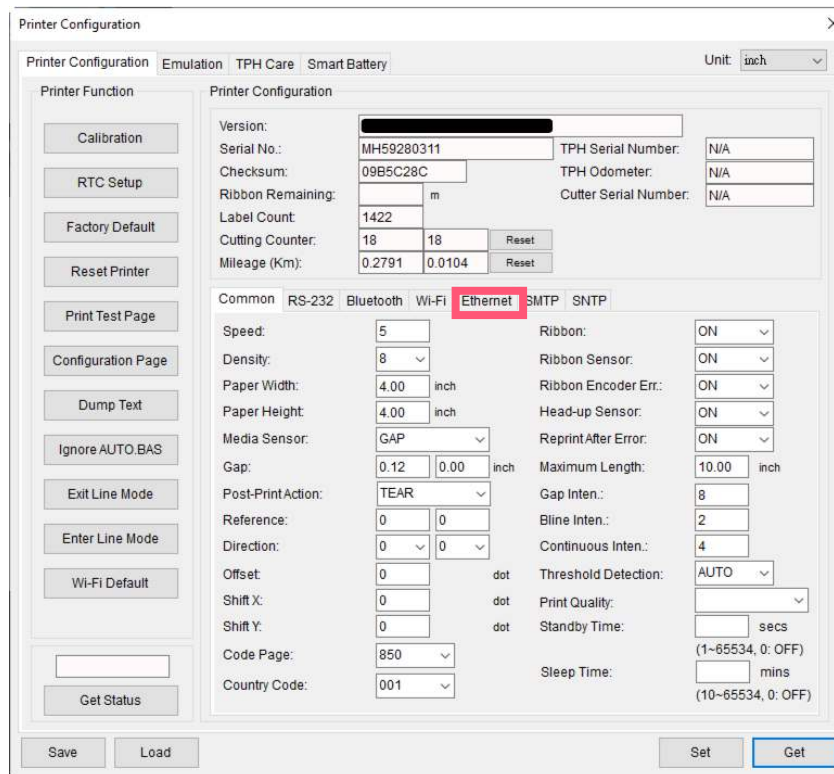

The screenshot shows the Printer Configuration dialog box. The 'Printer Configuration' tab is selected. The 'Ethernet' sub-tab is also selected. The 'DHCP' radio button is selected, and the 'Static IP' radio button is unselected. The IP Address field is highlighted with a red box. The IP Address field contains the value '10.0.10.181'. The Subnet Mask field contains '255.255.255.0'. The Gateway field contains '10.0.10.251'. The MAC Address field contains '00-1B-82-E0-12-2A'. There are 'Set' buttons next to the IP Address, Subnet Mask, Gateway, and MAC Address fields. The 'Printer Name' field contains 'PS-E0122A' and has a 'Set' button. The 'Raw Port' field contains '9100' and has a 'Set' button. The 'Save' and 'Load' buttons are at the bottom left. The 'Set' and 'Get' buttons are at the bottom right.

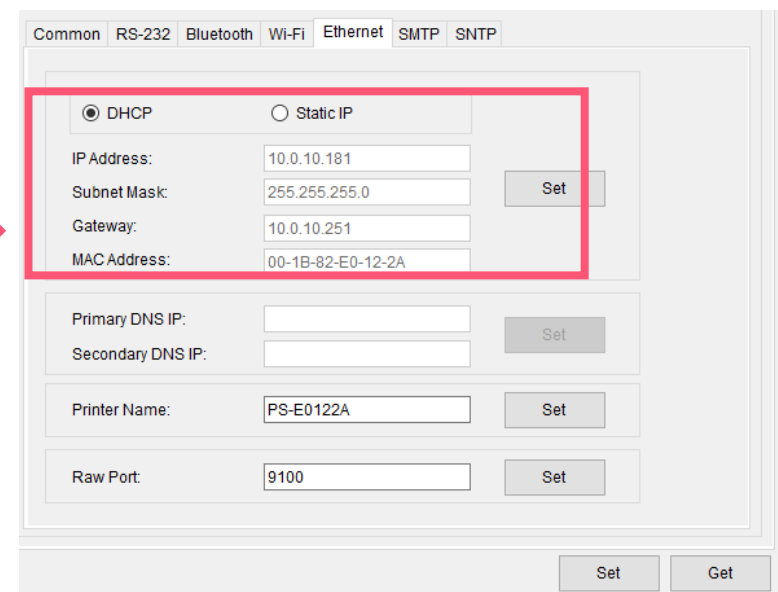

The screenshot shows the Ethernet configuration details. The 'DHCP' radio button is selected, and the 'Static IP' radio button is unselected. The IP Address field contains '10.0.10.181'. The Subnet Mask field contains '255.255.255.0'. The Gateway field contains '10.0.10.251'. The MAC Address field contains '00-1B-82-E0-12-2A'. There are 'Set' buttons next to the IP Address, Subnet Mask, Gateway, and MAC Address fields. The 'Printer Name' field contains 'PS-E0122A' and has a 'Set' button. The 'Raw Port' field contains '9100' and has a 'Set' button. The 'Set' and 'Get' buttons are at the bottom right.



- Return to **TSC Console** main page > Click **Add Printer** on the top left of the window.

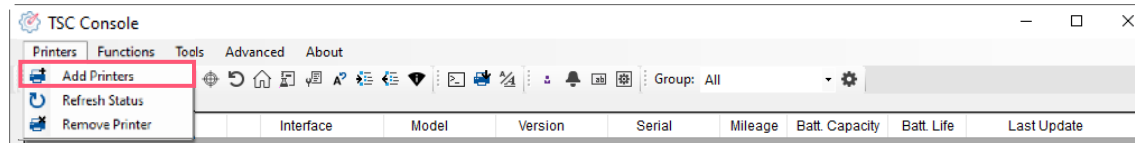

- Choose **Network** > Key in the **IP Address** > Click **Discover** to establish the Ethernet interface.

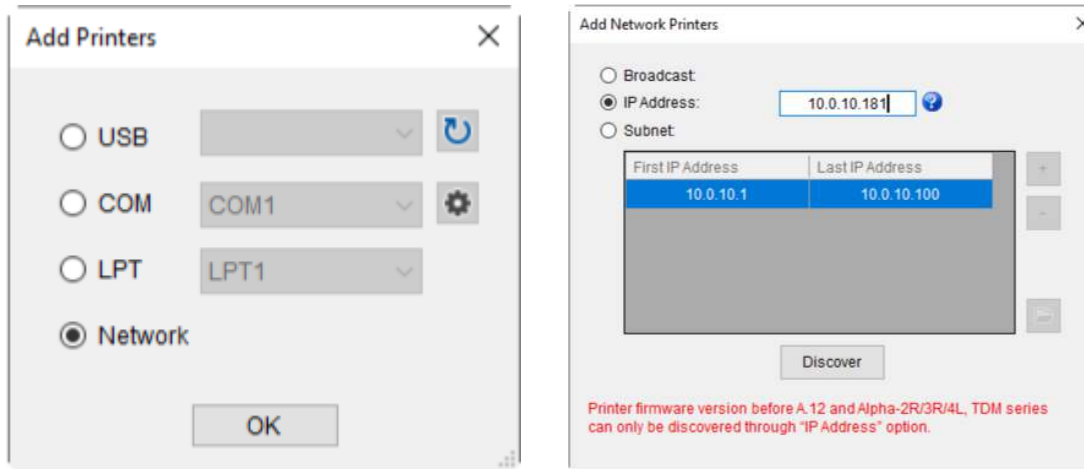

- The notification will pop up > Click **OK** to close the window > The Ethernet interface will be shown on **TSC Console**.

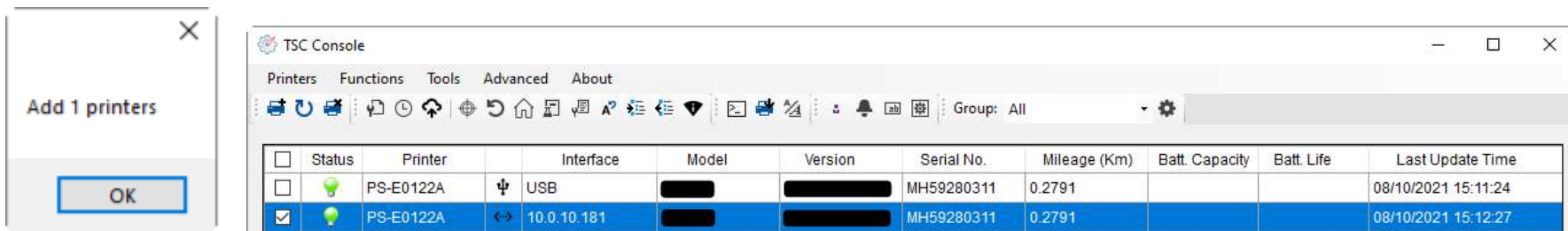

# 5.3 Set Wi-Fi and Add to TSC Console Interface

- Use **USB** or **COM Port** to set up the interface.  
(refer to chp.5.1)
- Double click to enter the printer configuration page.

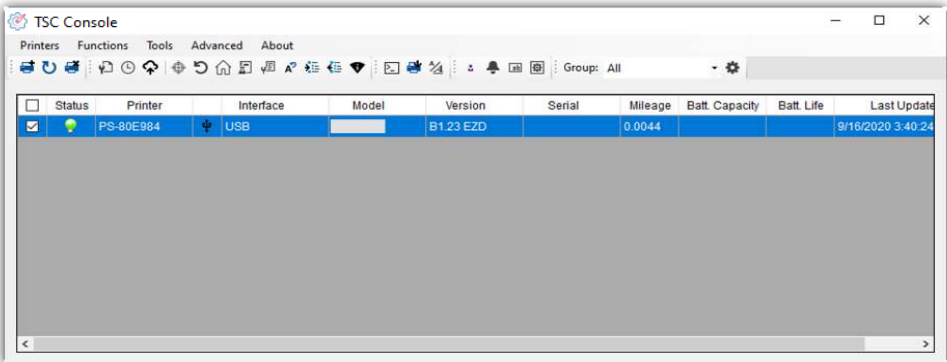

- Click **Get** to receive printer's information.
- Click **Wi-Fi** to the wi-fi setting page.

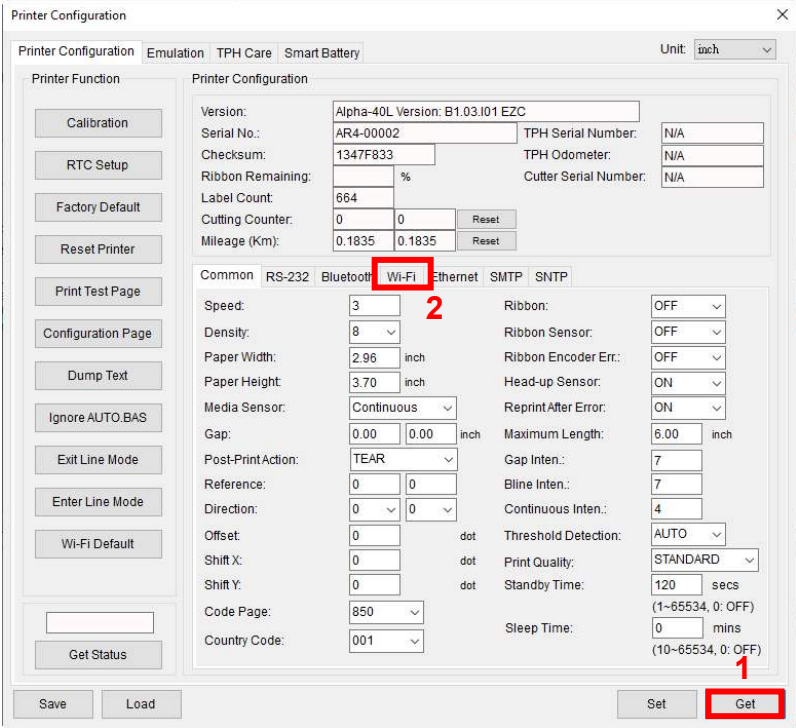

### For WPA-Personal

- I. Fill-in the **SSID**.
- II. Select the Encryption option to **WPA-Personal**.
- III. Fill-in the Key.
- IV. Select **DHCP** to **ON**. (For **OFF** option, please fill-in the IP Address, Subnet Mask and Gateway)
- V. After setting, click the **Set** button.

#### Note:

Before setting, the entered field will be shown in yellow for reminding.

On DHCP, user can change the printer name by another model name in "Printer Name" field.

User also can change the raw port in "Raw Port" field.

Common RS-232 Bluetooth Wi-Fi Ethernet SMTP SNTP

Built-in Wi-Fi Module

SSID: SSID\_1

WLAN Encryption: WPA-Personal

Key: ●●●●

DHCP: ON

IP Address: 1

Subnet Mask: 0.0.0.0

Gateway:

Primary DNS IP:

Secondary DNS IP:

Raw Port: 9100

Printer Name: PS-FF153C

MAC Address: 00:1B:82:FF:15:3C

EAP Type:

Username:

Password:

CA Certificate:

Client Certificate:

Private Key:

EAP-FAST PAC:

File Name Browse

Wi-Fi Version: 3.7.1.0R6

RSSI: 0

Set Get

### For WPA-Enterprise

- I. Fill-in the **SSID**.
- II. Select the Encryption option to **WPA2-Enterprise**.
- III. Select DHCP to **ON** (For **OFF** option, please fill-in the IP Address, Subnet Mask and Gateway)
- IV. Select the **EAP Type** option. (For **EAP-TLS** option, please upload the CA and Key for mutual authentication, integrity-protected cipher suite negotiation, and key exchange between two endpoints.)
- V. After setting, click the **Set** button.

#### Note:

Before setting, the entered field will be shown in yellow for reminding.

On DHCP, user can change the printer name by another model name in "Printer Name" field.

User also can change the raw port in "Raw Port" field.

Common RS-232 Bluetooth Wi-Fi Ethernet SMTP SNTP

Built-in Wi-Fi Module

SSID: SSID\_2

WLAN Encryption: WPA-Enterprise

Key: ●●●●

DHCP: ON

IP Address: 1

Subnet Mask: 0.0.0.0

Gateway:

Primary DNS IP:

Secondary DNS IP:

Raw Port: 9100

Printer Name: PS-FF153C

MAC Address: 00:1B:82:FF:15:3C

EAP Type:

Username:

Password:

CA Certificate:

Client Certificate:

Private Key:

EAP-FAST PAC:

File Name Browse

Wi-Fi Version: 3.7.1.0R6

RSSI: 0

Set Get

- After clicking **Set** button, it'll pop-up the window tip as below shown.

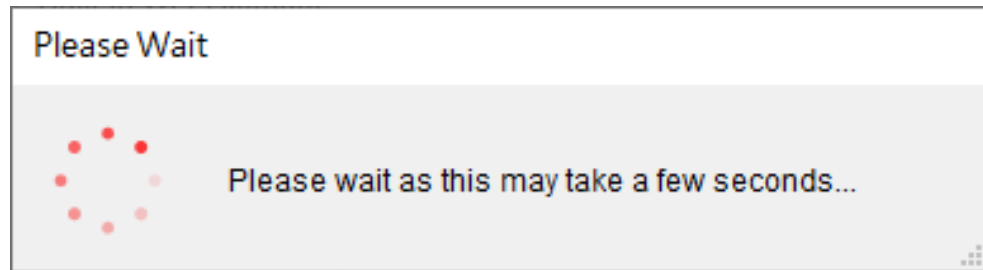

- IP address will be shown in the "IP address" field.  
**Note:**  
IP address should be shown within about 5~15 seconds after printer turn on. If not, please refer to steps below to initialize the printer Wi-Fi module settings then to setup it again.

- Remove cable between the computer and the printer.
- Go to main page, click **Add Printer** to add the printer via **Network**.
- Select the printer and enter the setting page by double clicking the printer.
- Click the **Print Test Page** button to print the test page via Wi-Fi interface.

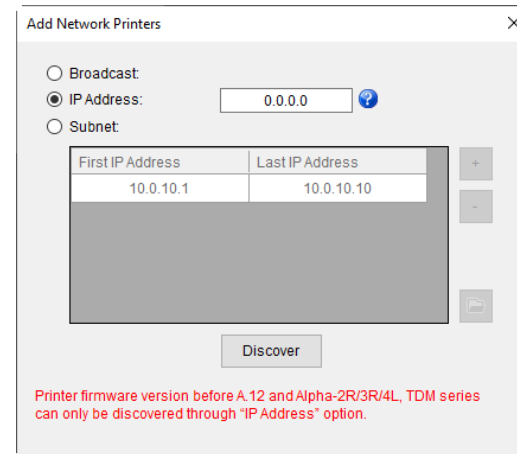

## 5.4 Initialize the Printer Wi-Fi Setting

1. Return to the main page of TSC Console.

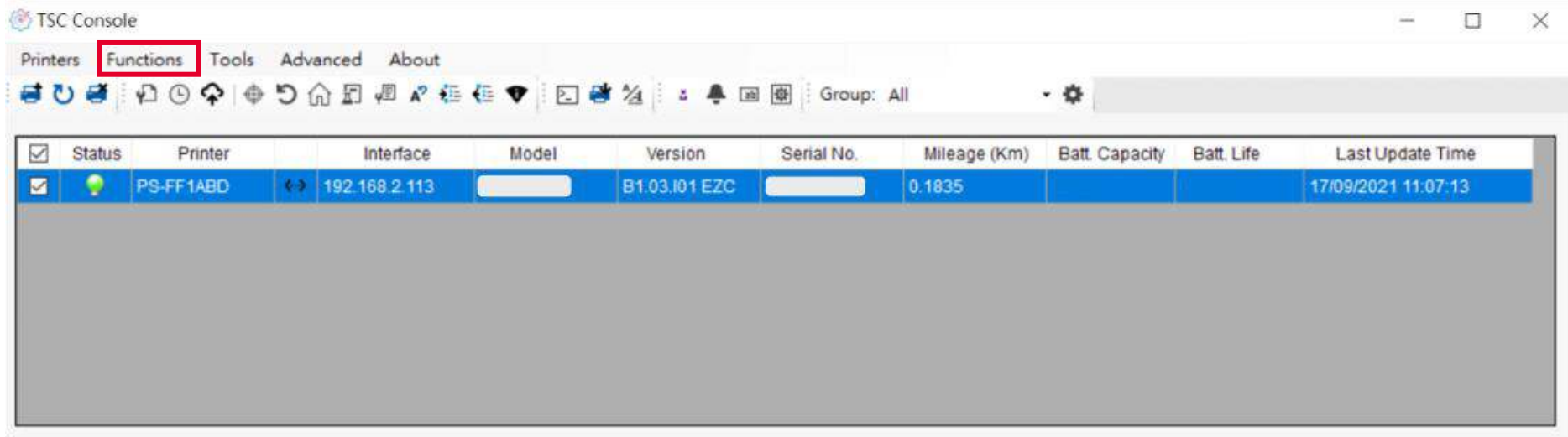

2. Click **Functions** to expand the page.
3. Click **Wi-Fi Default** to initialize the printer Wi-Fi module setting to factory default setting.

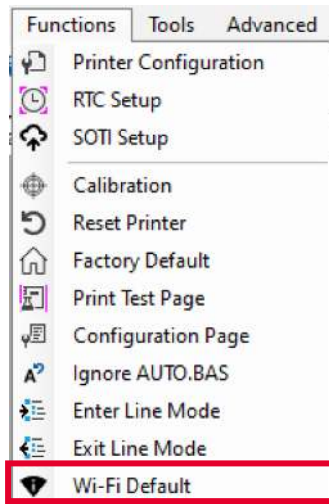

## 5.5 TPH Care

**TPH Care** provides users to check the condition of the print head and be able to set the dot failure threshold for indicating errors when the threshold is triggered.

This option is used to enable (ON)/ disable (OFF) the TPH care function.

This option is used to check the numbers of unhealthy TPH dot element.

This option is used to detect the unhealthy TPH dot.

This option is used to set the threshold for unhealthy TPH dot number.

This image is used to check the relative position of the unhealthy TPH dot.

This option is used to print a TPH test image to check the TPH printing result.

1. Enable the TPH Care function. (Note: The default is disabled/OFF.) Then click "Get TPH care profile" button and a diagram will show in the area above.
2. If the profile is flat, it means that the print head is good. Check "Unhealthy TPH dot number". If the result is zero (0), that means the print head is good.
3. Bad dots are presented as a spike in the profile. The arrow in below profile indicates the presence of potentially damaged dots and printer will stop printing.

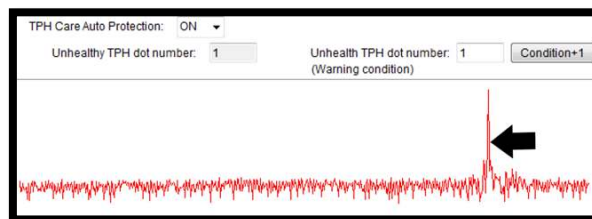

## 5.6 Printer Function

Printer Function could be found in **Printer Configuration**. “Printer Function” will be shown on the left side of the window.

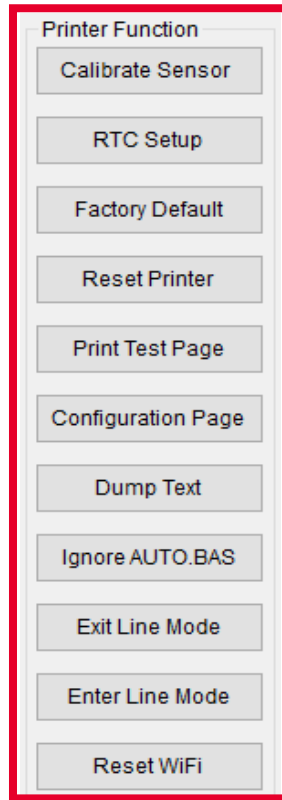

Functions	Description
<b>Calibrate Sensor</b>	Detect media types and the size of the label
<b>RTC Setup</b>	Synchronize printer with Real Time Clock on PC
<b>Factory Default</b>	Initialize the printer to default settings
<b>Reset Printer</b>	Reboot printer
<b>Print Test Page</b>	Print test page according to the specified label size and sensor type.
<b>Configuration Page</b>	Print printer configurations
<b>Dump Text</b>	Activate the printer to dump mode
<b>Ignore AUTO.BAS</b>	Ignore AUTO.BAS file when printer boot up.
<b>Exit Line Mode</b>	Exit the line mode to page mode
<b>Enter Line Mode</b>	Leave page mode and enter line mode
<b>Reset WiFi</b>	Restore the WiFi settings to defaults.

## 5.7 Setting Post-Print Action

When the printer is equipped with other option kits, ex: cutter, peeler, rewinder, please select the mode after finishing the calibration.

Follow below procedure to set the post action for the printing:

Refer Ch. 5.1 to Connect the printer with TSC Console > Double click the printer > The Printer Configuration Page will pop up > Click Get to load information > Go to Common Tab > Find Post-Print Action > Select the mode depends on users' application > Click Set.

Printer Configuration

Printer Configuration Emulation TPH Care Smart Battery Unit: mm

Printer Function

Calibration

RTC Setup

Factory Default

Reset Printer

Print Test Page

Configuration Page

Dump Text

Ignore AUTO.BAS

Exit Line Mode

Enter Line Mode

Wi-Fi Default

Get Status

Save Load

Printer Configuration

Version: [ ]

Serial No.: [ ] TPH Serial Number: N/A

Checksum: 1344B9B1 TPH Odometer: N/A

Ribbon Remaining: [ ] % Cutter Serial Number: N/A

Label Count: 553

Cutting Counter: 0 0 Reset

Mileage (Km): 0.0913 0.0913 Reset

Common RS-232 Bluetooth Wi-Fi Ethernet SMTP SNTP

Speed: 3 Ribbon: OFF

Density: 8 Ribbon Sensor: OFF

Paper Width: 104.00 mm Ribbon Encoder Err.: OFF

Paper Height: 74.05 mm Head-up Sensor: ON

Media Sensor: Black Mark Reprint After Error: ON

Gap: 1.99 0.00 mm Maximum Length: 152.25 mm

Post-Print Action: [ ] Gap Inten.: 7

Reference: OFF Bline Inten.: 7

Direction: TEAR Continuous Inten.: 4

Offset: PEEL Threshold Detection: AUTO

Shift X: CUTTER Print Quality: STANDARD

Shift Y: REWIND Standby Time: 120 secs

Code Page: 850 Sleep Time: 0 mins

Country Code: 001 (1~65534, 0: OFF)

(10~65534, 0: OFF)

3 1

Set Get



# 6. Troubleshooting

Problem	Possible Cause	Recovery Procedure
Power indicator does not illuminate.	* The power cord is not properly connected.	* Plug the power cord in printer and outlet. * Switch the printer on.
-The printer status from TSC		
Console shows “Head Open”.	* The printer carriage is open.	* Please close the print carriage.
- The LED shows “Red (solid)”.		
- The printer status from TSC		
Console shows “Ribbon End Err.”	* Running out of ribbon. * The ribbon is installed incorrectly.	* Supply a new ribbon roll. * Please refer to the steps on section 3.2 to re-install the ribbon.
Or “Ribbon Encoder Err.”		
- The LED shows “Red (blinking)”.		
- The printer status from TSC		
Console shows “Out of Paper”.	* Running out of label. * The label is installed incorrectly. * Gap/black mark sensor is not calibrated.	* Supply a new label roll. * Calibrate the gap/black mark sensor.
- The LED shows “Red (blinking)”.		
- The printer status from TSC		
Console shows “Paper Jam”.	* Gap/black mark sensor is not set properly. * Make sure label size is set properly. * Labels may be stuck inside the printer mechanism.	* Calibrate the gap/black mark sensor. * Set label size correctly.
- The LED shows “Red (blinking)”.		
Not Printing	* Cable is not well connected to serial or USB interface or parallel port. * The serial port cable pin configuration is not pin to pin connected.	* Re-connect cable to interface. * Change a new cable. * Ribbon and media are not compatible. * Verify the ribbon-inked side. * Reload the ribbon again. * Clean the print head. * The print density setting is incorrect. * Print head’s harness connector is not well connected with printhead. Turn off the printer and plug the connector again. * Check your program if there is a command PRINT at the end of the file and there must have CRLF at the end of each

command line.

### Memory full (FLASH/ DRAM)

\* The space of FLASH/DRAM is full.

\* Delete unused files in the FLASH/DRAM.

### Poor Print Quality

\* Ribbon and media are loaded incorrectly  
\* Dust or adhesive accumulation on the print head.  
\* Print density is not set properly.  
\* Printhead element is damaged.  
\* Ribbon and media are incompatible.

\* Reload the supply.  
\* Clean the print head.  
\* Clean the platen roller.  
\* Adjust the print density and print speed.  
\* Run printer self-test and check the print head test pattern if there is dot missing in the pattern.  
\* Change proper ribbon or proper label media.  
\* The print head mechanism does not latch the print head properly.

### Skip labels when printing

\* Label size is not specified properly.  
\* Sensor sensitivity is not set properly.  
\* The media sensor is covered with dust.

\* Check if label size is setup correctly.  
\* Calibrate the sensor by Auto Gap or Manual Gap options.  
\* Clear the GAP/Black mark sensor by blower.

### The printing position of small label is incorrect

\* Media sensor sensitivity is not set properly.  
\* Label size is incorrect.  
\* The vertical offset setting in the driver is incorrect.

\* Calibrate the sensor sensitivity again.  
\* Set the correct label size and gap size.  
\* If using the labeling software, please set the vertical offset in the driver.

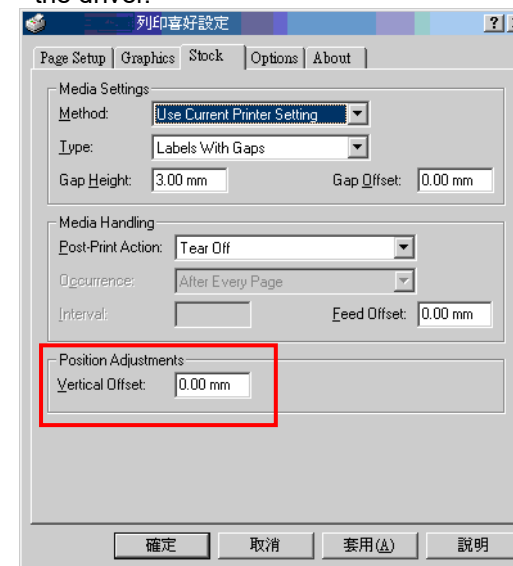

### Missing printing on the left or right side of label

\* Wrong label size setup.

\* Set the correct label size.

**Wrinkle problem**

- \* Ribbon installation is incorrect.
- \* Media installation is incorrect.
- \* Print density is incorrect.
- \* Media feeding is incorrect.

- \* Please set the suitable density to have good print quality.
- \* Make sure the label guide to touch the edge of the media guide.

**Gray line on the blank label**

- \* The print head is dirty.
- \* The platen roller is dirty.

- \* Clean the print head.
- \* Clean the platen roller.

**Irregular printing**

- \* The printer is in Hex Dump mode.

- \* Turn off and on the printer to skip the dump mode.

# 7. Maintenance

This session presents the clean tools and methods to maintain the printer.

## ■ For Cleaning

Depending on the media used, the printer may accumulate residues (media dust, adhesives, etc.) as a by-product of normal printing. To maintain the best printing quality, you should remove these residues by cleaning the printer periodically. Regularly clean the print head and supply sensors once change a new media to keep the printer at the optimized performance and extend printer life.

## ■ For Disinfecting

Sanitize your printer to protect yourself and others and can help prevent the spread of viruses.

## ■ Important

- Set the printer power switch to O (Off) prior to performing any cleaning or disinfecting tasks. Leave the power cord connected to keep the printer grounded and to reduce the risk of electrostatic damage.
- Do not wear rings or other metallic objects while cleaning any interior area of the printer.
- Use only the cleaning agents recommended in this document. Use of other agents may damage the printer and void its warranty.
- Do not spray or drip liquid cleaning solutions directly into the printer. Apply the solution on a clean lint-free cloth and then apply the dampened cloth to the printer.
- Do not use canned air in the interior of the printer as it can blow dust and debris onto sensors and other critical components.
- Only use a vacuum cleaner with a nozzle and hose that are conductive and grounded to drain off static build up.
- All reference in these procedures for use of isopropyl alcohol requires that a 99% or greater isopropyl alcohol content be used to reduce the risk of moisture corrosion to the printhead.
- Do not touch printhead by hand. If you touch it carelessly, please use 99% Isopropyl alcohol to clean it.
- Always taking personal precaution when using any cleaning agent.

## Cleaning Tools

- Cotton swab
- Lint-free cloth
- Brush with soft non-metallic bristles
- Vacuum cleaner
- 75% Ethanol (for disinfecting)
- 99% Isopropyl alcohol (for printhead and platen roller cleaning)
- Genuine printhead cleaning pen
- Mild detergent (without chlorine)

## Cleaning Process:

Printer Part	Method	Interval
<b>Print Head</b>	<ol style="list-style-type: none"> <li>I. Always turn off the printer before cleaning the printhead.</li> <li>II. Allow the printhead to cool for at least one minute.</li> <li>III. Use a cotton swab and 99% Isopropyl Alcohol or genuine print head cleaning pen to clean the print head surface.</li> </ol>	Clean the print head when changing a new label roll.
<b>Platen Roller</b>	<ol style="list-style-type: none"> <li>I. Turn off the printer.</li> <li>II. Rotate the platen roller and wipe it thoroughly with the lint-free 99% Isopropyl Alcohol.</li> </ol>	Clean the platen roller when changing a new label roll
<b>Peel Bar</b>	Use the lint-free cloth with 99% Isopropyl Alcohol to wipe it.	As needed
<b>Sensor</b>	Use brush with soft non-metallic bristles or a vacuum cleaner, to remove paper dust. Clean upper and lower media sensors to ensure reliable Top of Form and Paper Out sensing.	Monthly
<b>Exterior</b>	Clean the exterior surfaces with a clean, lint-free cloth (water-dampened cloth). If necessary, use a mild detergent or desktop cleaning solution then use the 75% Ethanol to wipe it.	As needed
<b>Interior</b>	Clean the interior of the printer by removing any dirt and lint with a vacuum cleaner, as described above, or use a brush with soft non-metallic bristles then use the 75% Ethanol to wipe it.	As needed

## 8. Agency Compliance and Approvals



**TE200/TE300 Series:**

**EN 55032, Class A**

**EN 55024**

**EN 60950-1**

**This is a class A product. In a domestic environment this product may cause radio interference in which case the user may be required to take adequate measures.**

**TE210/TE310 Series:**

**EN 55032, Class B**

**EN 55024**

**EN 61000-3-2**

**EN 61000-3-3**

**EN 60950-1**



**TE200/TE300 Series:**

**FCC part 15B, Class A**

**ICES-003, Class A**

This equipment has been tested and found to comply with the limits for a Class A digital device, pursuant to Part 15 of the FCC Rules. These limits are designed to provide reasonable protection against harmful interference when the equipment is operated in a commercial environment.

This equipment generates, uses, and can radiate radio frequency energy and, if not installed and used in accordance with the manufacturer's instruction manual, may cause harmful interference with radio communications. Operation of this equipment in a residential area is likely to cause harmful interference, in which case you will be required to correct the interference at your own expense.

**This Class A digital apparatus complies with Canadian ICES-003.**

**Cet appareil numérique de la classe A est conform à la norme NMB-003 du Canada.**

This device complies with Part 15 of the FCC Rules. Operation is subject to the following two conditions:

(1) This device may cause harmful interference, and (2) this device must accept any interference received, including interference that may cause undesired operation.

**TE210/TE310 Series:**

FCC part 15B, Class B

This equipment has been tested and found to comply with the limits for a Class B digital device, pursuant to part 15 of the FCC Rules. These limits are designed to provide reasonable protection against harmful interference in a residential installation. This equipment generates, uses and can radiate radio frequency energy and, if not installed and used in accordance with the instructions, may cause harmful interference to radio communications. However, there is no guarantee that interference will not occur in a particular installation. If this equipment does cause harmful interference to radio or television reception, which can be determined by turning the equipment off and on, the user is encouraged to try to correct the interference by one or more of the following measures:

- Reorient or relocate the receiving antenna.
- Increase the separation between the equipment and receiver.
- Connect the equipment into an outlet on a circuit different from that to which the receiver is connected.
- Consult the dealer or an experienced radio/ TV technician for help.

This device complies with Part 15 of the FCC Rules. Operation is subject to the following two conditions:

(1) This device may cause harmful interference, and (2) this device must accept any interference received, including interference that may cause undesired operation.

**This Class B digital apparatus complies with Canadian ICES-003**

**Cet appareil numérique de la classe B est conforme à la norme NMB-003 du Canada.**



**TE200/TE300 Series:**

AS/NZS CISPR 32, Class A

**TE210/TE310 Series:**

AS/NZS CISPR 32, Class B

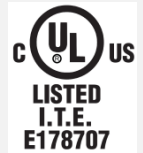

UL 60950-1

CSA C22.2 No. 60950-1-07



EN 60950-1

**TE200/TE300 Series:**

GB 4943.1

GB 9254, Class A

GB 17625.1



此为 A 级产品，在生活环境中，该产品可能会造成无线电干扰，

在这种情况下，可能需要用户对干扰采取切实可行的措施。

**TE210/TE310 Series:**

GB 4943.1

GB 9254, Class B

GB 17625.1





## Energy Star for Imaging Equipment Version 2.0



TP TC 004  
TP TC 020



IS 13252(Part 1)/  
IEC 60950-1



KN 32  
KN 35

Note: There may have certification differences in the series models, please refer to product label for accuracy.

### **Important safety instructions:**

1. Read all of these instructions and keep them for later use.
2. Follow all warnings and instructions on the product.
3. Disconnect the power plug from the AC outlet before cleaning or if fault happened.  
Do not use liquid or aerosol cleaners. Using a damp cloth is suitable for cleaning.
4. The mains socket shall be installed near the equipment and easily accessible.
5. The unit must be protected against moisture.
6. Ensure the stability when installing the device, Tipping or dropping could cause damage.
7. Make sure to follow the correct power rating and power type indicated on marking label provided by manufacture.
8. Please refer to user manual for maximum operation ambient temperature.

### **WARNING:**

Hazardous moving parts, keep fingers and other body parts away.

**CAUTION:**

(For equipment with RTC (CR2032) battery or rechargeable battery pack)

Risk of explosion if battery is replaced by an incorrect type.

Dispose of used batteries according to the Instructions as below.

1. DO NOT throw the battery in fire.
2. DO NOT short circuit the contacts.
3. DO NOT disassemble the battery.
4. DO NOT throw the battery in municipal waste.
5. The symbol of the crossed out wheeled bin indicates that the battery should not be placed in municipal waste.



**Caution:** The printhead may be hot and could cause severe burns. Allow the printhead to cool.

**CAUTION:**

Any changes or modifications not expressly approved by the grantee of this device could void the user's authority to operate the equipment.

**CE Statement:**

This equipment complies with EU radiation exposure limits set forth for an uncontrolled environment. This equipment should be installed and operated with minimum distance 20 cm between the radiator & your body.

All operational modes:

2.4GHz: 802.11b, 802.11g, 802.11n (HT20), 802.11n (HT40)

5GHz: 802.11a,

The frequency, mode and the maximum transmitted power in EU are listed below:

2400 MHz – 2483.5 MHz: 19.88 dBm (EIRP)

5150 MHz – 5250 MHz: 17.51 dBm (EIRP)

5150-5350MHz for Only indoor use

5470-5725MHz for indoor/outdoor use

### Restrictions In AZE

National restrictions information is provided below

Frequency Band	Country	Remark
5150-5350MHz	Azerbaijan	No license needed if used indoor and power not exceeding 30mW
5470-5725MHz		

Hereby, TSC Auto ID Technology Co., Ltd. declares that the radio equipment type [Wi-Fi] IEEE 802.11 a/b/g/n is in compliance with Directive 2014/53/EU

The full text of the EU declaration of conformity is available at the following internet address: [http:// www.tscprinters.com](http://www.tscprinters.com)

### RF exposure warning (Wi-Fi)

This equipment must be installed and operated in accordance with provided instructions and must not be co-located or operating in conjunction with any other antenna or transmitter. End-users and installers must be providing with antenna installation instructions and transmitter operating conditions for satisfying RF exposure compliance.

SAR Value: 0.736 W/kg

### RF exposure warning (For Bluetooth)

The equipment complies with FCC RF exposure limits set forth for an uncontrolled environment.

The equipment must not be co-located or operating in conjunction with any other antenna or transmitter.

### Canada, Industry Canada (IC) Notices

This Class B digital apparatus complies with Canadian ICES-003 and RSS-210.

Operation is subject to the following two conditions: (1) this device may not cause interference, and (2) this device must accept any interference, including interference that may cause undesired operation of the device.

### **Radio Frequency (RF) Exposure Information**

The radiated output power of the Wireless Device is below the Industry Canada (IC) radio frequency exposure limits. The Wireless Device should be used in such a manner such that the potential for human contact during normal operation is minimized.

This device has been evaluated for and shown compliant with the IC Specific Absorption Rate (“SAR”) limits when installed in specific host products operated in portable exposure conditions. **(For Wi-Fi)**

This device has also been evaluated and shown compliant with the IC RF Exposure limits under portable exposure conditions. (Antennas are less than 20 cm of a person's body). **(For Bluetooth)**

### **Canada, avis de l'Industry Canada (IC)**

Cet appareil numérique de classe B est conforme aux normes canadiennes ICES-003 et RSS-210.

Son fonctionnement est soumis aux deux conditions suivantes : (1) cet appareil ne doit pas causer d'interférence et (2) cet appareil doit accepter toute interférence, notamment les interférences qui peuvent affecter son fonctionnement.

### **Informations concernant l'exposition aux fréquences radio (RF)**

La puissance de sortie émise par l'appareil sans fil est inférieure à la limite d'exposition aux fréquences radio de l'Industry Canada (IC). Utilisez l'appareil sans fil de façon à minimiser les contacts humains lors du fonctionnement normal.

Ce périphérique a été évalué et démontré conforme aux limites SAR (Specific Absorption Rate – Taux d'absorption spécifique) par l'IC lorsqu'il est connecté à des dispositifs hôtes spécifiques opérant dans des conditions d'utilisation mobile. **(Pour le Wi-Fi)**

Ce périphérique a également été évalué et démontré conforme aux limites d'exposition radio-fréquence par l'IC pour des utilisations par des opérateurs mobiles (les antennes sont à moins de 20 cm du corps d'une personne). **(Pour le Bluetooth)**

### **NCC 警語:**

經型式認證合格之低功率射頻電機，非經許可，公司、商號或使用者均不得擅自變更頻率、加大功率或變更原設計之特性及功能。(即

低功率電波輻射性電機管理辦法第十二條)

低功率射頻電機之使用不得影響飛航安全及干擾合法通信；經發現有干擾現象時，應立即停用，並改善至無干擾時方得繼續使用。

前項合法通信，指依電信法規定作業之無線電通信。低功率射頻電機須忍受合法通信或工業、科學及醫療用電波輻射性電機設備之干擾。(即低功率電波輻射性電機管理辦法第十四條)

**BSMI Class A 警語:**

這是甲類的資訊產品，在居住的環境使用中時，可能會造成射頻 干擾，在這種情況下，使用者會被要求採取某些適當的對策。

<b>Model Name</b>	<b>Resolution</b>	<b>Print Speed</b>
<b>TE200 series</b>	<b>203 dpi</b>	<b>Up to 6 IPS</b>
<b>TE300 series</b>	<b>300 dpi</b>	<b>Up to 5 IPS</b>

設備名稱 Equipment name : 熱轉式/熱感式條碼印表機 .

型號 ( 型式 ) Type designation (Type) : TE200 系列

單元 Unit	限用物質及其化學符號 Restricted substances and its chemical symbols					
	鉛 Lead (Pb)	汞 Mercury (Hg)	鎘 Cadmium (Cd)	六價鉻 Hexavalent chromium (Cr <sup>+6</sup> )	多溴聯苯 Polybrominated biphenyls (PBB)	多溴二苯醚 Polybrominated diphenyl ethers (PBDE)
內外塑膠件	○	○	○	○	○	○
內外鐵件	○	○	○	○	○	○
滾輪	○	○	○	○	○	○
電路板組件	-	○	○	○	○	○
晶片電阻	-	○	○	○	○	○
積層陶瓷表面黏著 電容	○	○	○	○	○	○

集成電路-IC	○	○	○	○	○	○
電源供應器	○	○	○	○	○	○
印字頭	○	○	○	○	○	○
馬達	-	○	○	○	○	○
插座	○	○	○	○	○	○
線材	○	○	○	○	○	○
<p>備考 1. “超出 0.1 wt %” 及 “超出 0.01 wt %” 係指限用物質之百分比含量超出百分比含量基準值。  Note 1 : “Exceeding 0.1 wt %” and “exceeding 0.01 wt %” indicate that the percentage content of the restricted substance exceeds the reference percentage value of presence condition.</p> <p>備考 2. “○” 係指該項限用物質之百分比含量未超出百分比含量基準值。  Note 2 : “○” indicates that the percentage content of the restricted substance does not exceed the percentage of reference value of presence.</p> <p>備考 3. “-” 係指該項限用物質為排除項目。  Note 3 : The “-” indicates that the restricted substance corresponds to the exemption.</p>						

For MFi Bluetooth



Use of the Made for Apple badge means that an accessory has been designed to connect specifically to the Apple product(s) identified in the badge, and has been certified by the developer to meet Apple performance standards. Apple is not responsible for the operation of this device or its compliance with safety and regulatory standards.

#### For US Model

Made for iPhone®XS Max, iPhone XS, iPhone XR, iPhone X, iPhone 8, iPhone 8 Plus, iPhone 7, iPhone 7 Plus, iPhone SE, iPhone 6s, iPhone 6s Plus, iPhone 6, iPhone 6 Plus, iPhone 5s, iPad Pro® 12.9-inch (2nd generation), iPad Pro 10.5-inch, iPad® (6th generation), iPad (5th generation), iPad Pro 9.7-inch, iPad Pro 12.9-inch (1st generation), iPad Air® 2, iPad mini™ 4, iPad mini 3, iPad Air, iPad mini 2, iPod touch® (6th generation)  
iPad, iPad Air, iPad Pro, iPhone are trademarks of Apple Inc., registered in the U.S. and other countries.

#### For JP Model

Made for iPhone XS Max, iPhone XS, iPhone XR, iPhone X, iPhone 8, iPhone 8 Plus, iPhone 7, iPhone 7 Plus, iPhone SE, iPhone 6s, iPhone 6s Plus, iPhone 6, iPhone 6 Plus, iPhone 5s, iPad Pro 12.9-inch (2nd generation), iPad Pro 10.5-inch, iPad (6th generation), iPad (5th generation), iPad Pro 9.7-inch, iPad Pro 12.9-inch (1st generation), iPad Air 2,  
iPad mini 4, iPad mini 3, iPad Air, iPad mini 2, iPod touch (6th generation)  
iPad, iPad Air, iPad Pro, iPhone are trademarks of Apple Inc., registered in the U.S. and other countries. The trademark “iPhone” is used in Japan with a license from Aiphone K.K.

#### Except for US, JP Model

Made for iPhone XS Max, iPhone XS, iPhone XR, iPhone X, iPhone 8, iPhone 8 Plus, iPhone 7, iPhone 7 Plus, iPhone SE, iPhone 6s, iPhone 6s Plus, iPhone 6, iPhone 6 Plus, iPhone 5s, iPad Pro 12.9-inch (2nd generation), iPad Pro 10.5-inch, iPad (6th generation), iPad (5th generation), iPad Pro 9.7-inch, iPad Pro 12.9-inch (1st generation), iPad Air 2,  
iPad mini 4, iPad mini 3, iPad Air, iPad mini 2, iPod touch (6th generation)  
iPad, iPad Air, iPad Pro, iPhone are trademarks of Apple Inc., registered in the U.S. and other countries.



## 9. Revision History

Date	Content	Editor
2023/8/10	Modify Introduction section	Camille

**TSC** **PRINTRONIX®**  
**AUTO ID**