

TX210 Series

Thermal Transfer / Direct Thermal
Desktop Barcode Printers



Series Lists:

TX210 / TX310 / TX610

Service Manual

Copyright Information

©2022 TSC Auto ID Technology Co., Ltd.

The copyright in this manual, the software and firmware in the printer described are owned by TSC Auto ID Technology Co., Ltd. All rights reserved.

CG Triumvirate is a trademark of Agfa Corporation. CG Triumvirate Bold Condensed font is under license from the Monotype Corporation. Windows is a registered trademark of Microsoft Corporation.

All other trademarks are the property of their respective owners. Information in this document is subject to change without notice and does not represent a commitment on the part of TSC Auto ID Technology Co. No part of this manual may be reproduced or transmitted in any form or by any means, for any purpose other than the purchaser's personal use, without the expressed written permission of TSC Auto ID Technology Co.



Table of Contents

1. Fundamental of the System.....	1
1.1 Printer Overview	1
Front View.....	1
Interior View	2
Rear View	3
2. Electronics.....	4
2.1 Summary of the Board Connectors	4
2.2 Interface Pin Configuration.....	19
3. Mechanism.....	21
3.1 Remove the Lower Cover	21
3.2 Remove the Mainboard.....	22
3.3 Replacing the Stepping Motor Module	23
3.4 Replacing the Black-mark Sensor Module	24
3.5 Replacing the Media Guide Assembly.....	25
3.6 Replacing the Media holder assembly.....	26
3.7 Replacing the LED/LCD module	28
3.8 Replacing the Ribbon Base Module	29
3.9 Replacing the Printhead Module	30

3.10 Replacing the Platen Roller assembly	31
3.11 Cutter Module Installation (Option).....	32
3.12 Peel-off Module Installation (Option)	33
3.13 Slot-in Wireless Interface Board Installation (Option)	37
3.14 Slot-in Wi-Fi module Installation (Option)	38
4. TroubleShooting	39
4.1 Common issues	39
Maintenance.....	42
Revise History	44



1. Fundamental of the System

1.1 Printer Overview

Front View



1. LED indicators
2. Feed/ Pause button
3. Paper exit chute
4. Top cover open lever
5. Power switch

Interior View



1. Ribbon rewind gear
2. Gap sensor (transmitter)
3. Media holder
4. Platen roller
5. Ribbon access cover
6. Ribbon rewind hub
7. Print head
8. Ribbon supply hub
9. Ribbon cover
10. Media holder locking switch
11. Media guides
12. Media guide adjustment button
13. Black mark sensor/ Gap sensor (receiver)

⚠ Caution:
Keep fingers and other body parts
away from the printer cover.



Rear View

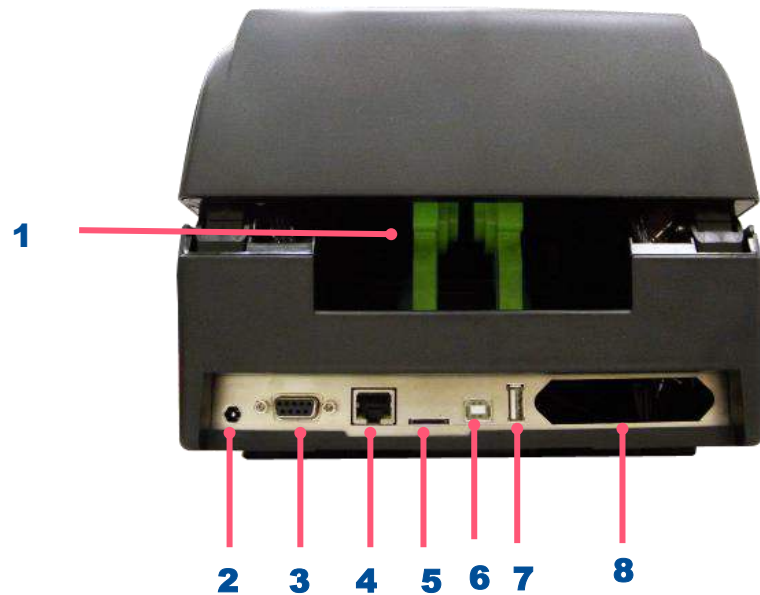

1. External label entrance chute
2. Power jack socket
3. RS-232C interface
4. Ethernet interface
5. Micro SD card socket
6. USB interface
7. USB host
8. Centronics interface (factory option)

⚠ Caution:
Keep fingers and other body parts away from the external label entrance chute.





Note: The interface picture here is for reference only. Please refer to the product specification for the interfaces availability.

2. Electronics

2.1 Summary of the Board Connectors

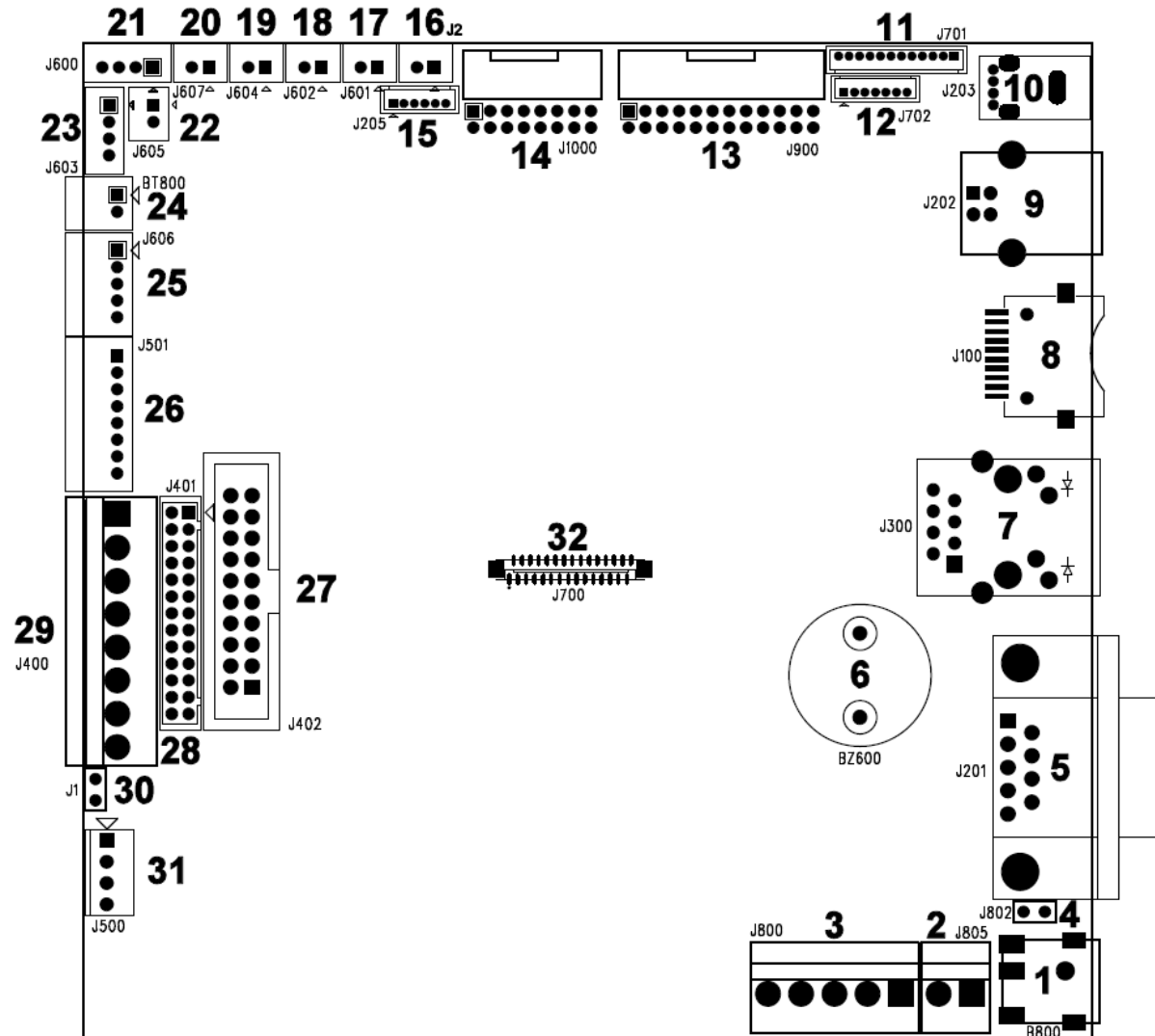
Main board for TX210 Series

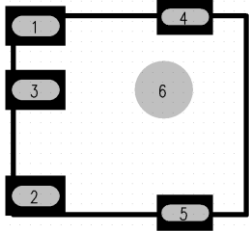
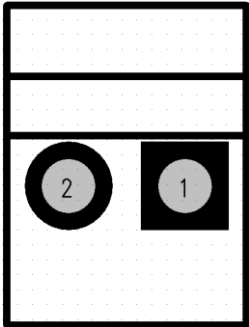
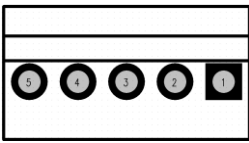

Connector	Description			Remark	
1	Power supply output (24V DC) connector				
		Pin	Description		
		1	DCIN 24V		
		2	GND		
		3	GND		
		4	GND		
5		GND			
2	TPH's ESD Cable connector				
		Pin	Description		
		1	GND		
2		GND			
3	Power switch cable connector				
		Pin	Description		
		1	DCIN 24V		
		2	DCIN 24V		
		3	SYS 24V		
		4	SYS 24V		
5		Discharge circuit			
4	Ribbon's ESD Cable connector				
		Pin	Description		
		1	GND		

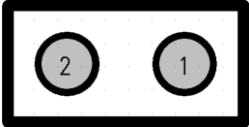
		2	GND	

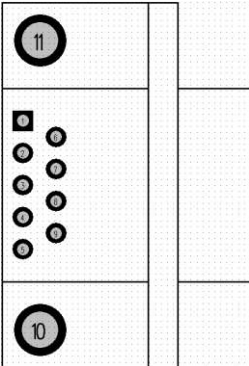
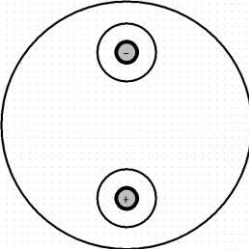
Connector	Description			Remark	
5	RS-232 Connector				
		Pin	Description		
		1	VBUS 5V		
		2	TXD		
		3	RXD		
		4	CTS		
		5	GND		
		6	RTS		
		7	NC		
		8	RTS		
9	NC				
6	Buzzer				
		Pin	Description		
		+	SYS 24V		
-	Buzzer control				
7	Ethernet connector				

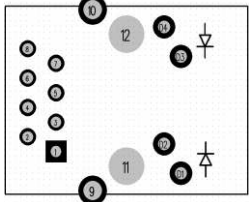
	Pin	Description
	1	TX+
	2	TX-
	3	RX+
	4	NC
	5	NC
	6	RX-
	7	NC
	8	FGND
	D1	3.3V
	D2	Green LED Control
	D3	Yellow LED Control
	D4	3.3V

Connector	Description	Remark
8	SD Card connector	
	Pin	Description
	1	Data2
	2	Data3
	3	Command
	4	3.3V
	5	Clock
	6	GND
	7	Data0
	8	Data1
	9	Card detect
10	Card detect	

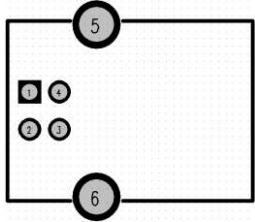
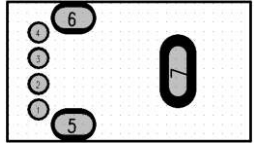
9	USB Host connector		
		Pin	Description
		1	NC
		2	D-
		3	D+
4	GND		
10	USB Device connector		
		Pin	Description
		1	VBUS 5V
		2	D-
		3	D+
4	GND		

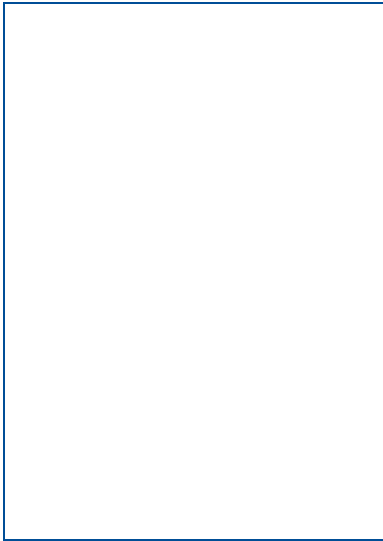
Connector	Description	Remark	
11	LED / KEY Connector		
		Pin	Description
		1	GND
		2	LED1 red : Warning
		3	LED2 red : No paper
		4	LED3 red : No ribbon
		5	LED4 red : Openings
6	3.3V		

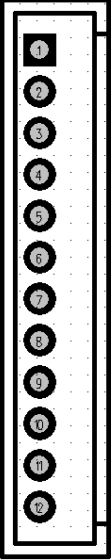
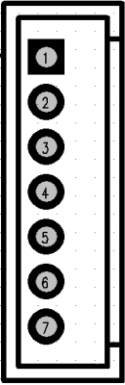
			7	LED5 green : Startup		
			8	LED6 orange : waiting		
			9	LED7 orange : Clean TPH		
			10	LED8 blue : Wi-Fi / BT		
			11	Feed switch		
			12	GND		
12	Panel's key connector					
			Pin	Description		
			1	KEY1 : Down switch		
			2	KEY2 : Left switch		
			3	KEY3 : Right switch		
			4	KEY4 : Up switch		
			5	KEY5 : Menu/Back switch		
			6	KEY6 : Feed switch		
		7	GND			

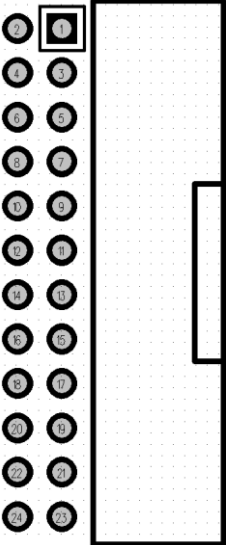
Connector	Description		Remark																																																		
13	Parallel port connector																																																				
		<table border="1"> <thead> <tr> <th data-bbox="902 204 1059 252">Pin</th> <th data-bbox="1064 204 1608 252">Description</th> </tr> </thead> <tbody> <tr><td>1</td><td>5V</td></tr> <tr><td>2</td><td>3.3V</td></tr> <tr><td>3</td><td>Data0</td></tr> <tr><td>4</td><td>NRD</td></tr> <tr><td>5</td><td>Data1</td></tr> <tr><td>6</td><td>AF</td></tr> <tr><td>7</td><td>Data2</td></tr> <tr><td>8</td><td>Strobe</td></tr> <tr><td>9</td><td>Data3</td></tr> <tr><td>10</td><td>Paper-End</td></tr> <tr><td>11</td><td>Data4</td></tr> <tr><td>12</td><td>Select</td></tr> <tr><td>13</td><td>Data5</td></tr> <tr><td>14</td><td>Error</td></tr> <tr><td>15</td><td>Data6</td></tr> <tr><td>16</td><td>ACK</td></tr> <tr><td>17</td><td>Data7</td></tr> <tr><td>18</td><td>Cancel data</td></tr> <tr><td>19</td><td>GND</td></tr> <tr><td>20</td><td>Busy</td></tr> <tr><td>21</td><td>GND</td></tr> <tr><td>22</td><td>NC</td></tr> <tr><td>23</td><td>GND</td></tr> <tr><td>24</td><td>NC</td></tr> </tbody> </table>	Pin	Description	1	5V	2	3.3V	3	Data0	4	NRD	5	Data1	6	AF	7	Data2	8	Strobe	9	Data3	10	Paper-End	11	Data4	12	Select	13	Data5	14	Error	15	Data6	16	ACK	17	Data7	18	Cancel data	19	GND	20	Busy	21	GND	22	NC	23	GND	24	NC	
	Pin	Description																																																			
	1	5V																																																			
	2	3.3V																																																			
	3	Data0																																																			
	4	NRD																																																			
	5	Data1																																																			
	6	AF																																																			
	7	Data2																																																			
	8	Strobe																																																			
	9	Data3																																																			
	10	Paper-End																																																			
	11	Data4																																																			
	12	Select																																																			
	13	Data5																																																			
	14	Error																																																			
	15	Data6																																																			
	16	ACK																																																			
	17	Data7																																																			
	18	Cancel data																																																			
	19	GND																																																			
	20	Busy																																																			
	21	GND																																																			
22	NC																																																				
23	GND																																																				
24	NC																																																				

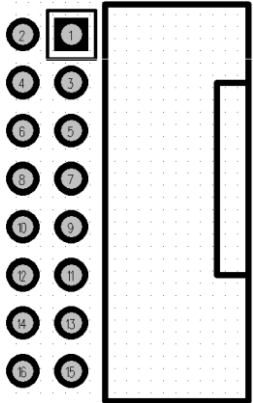
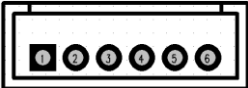
Connector	Description			Remark
14	Slot-in WIFI/BT Module connector			
		Pin	Description	
		1	3.3V	
		2	Reset	
		3	RXD	
		4	RTS	
		5	TXD	
		6	CTS	
		7	Wake up	
		8	Clock	
		9	NC	
		10	WIFI/BT Detect	
		11	GND	
		12	WLAN TX+	
		13	GND	
		14	WLAN TX-	
		15	WLAN RX-	
16		WLAN RX+		
15	RFID Connector			
		Pin	Description	
		1	RFID 5V	
		2	RXD	
		3	TXD	
		4	NC	
5		Power down signal		

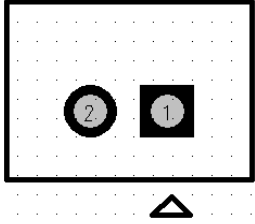
			6	GND
16	RFID Power Connector			
		Pin	Description	
		1	GND	
2	RFID 5V			

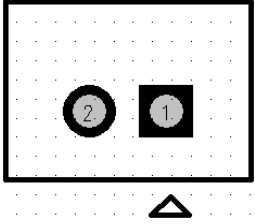
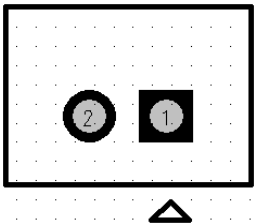
Connector	Description	Remark	
17	Ribbon end connector (For transmit signals)		
		Pin	Description
		1	3.3V
2	Ribbon end sensor emitter		
18	Gap sensor connector (For transmit signals)		
		Pin	Description
		1	3.3V
2	Gap sensor emitter		
19	Ribbon end connector (For receive signals)		

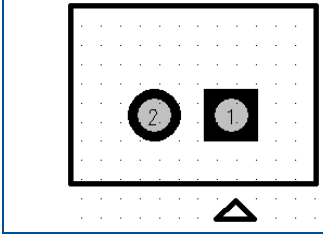
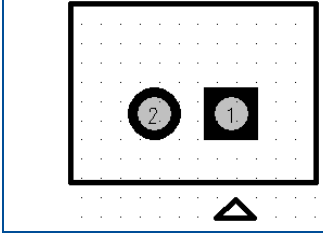
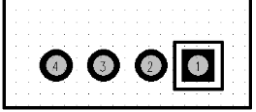
		<table border="1"> <thead> <tr> <th>Pin</th> <th>Description</th> </tr> </thead> <tbody> <tr> <td>1</td> <td>Ribbon end sensor receiver AD</td> </tr> <tr> <td>2</td> <td>GND</td> </tr> </tbody> </table>	Pin	Description	1	Ribbon end sensor receiver AD	2	GND				
Pin	Description											
1	Ribbon end sensor receiver AD											
2	GND											
20	Head open connector\											
		<table border="1"> <thead> <tr> <th>Pin</th> <th>Description</th> </tr> </thead> <tbody> <tr> <td>1</td> <td>Head open sensor receiver</td> </tr> <tr> <td>2</td> <td>GND</td> </tr> </tbody> </table>	Pin	Description	1	Head open sensor receiver	2	GND				
Pin	Description											
1	Head open sensor receiver											
2	GND											
21	Ribbon encoder sensor connector											
		<table border="1"> <thead> <tr> <th>Pin</th> <th>Description</th> </tr> </thead> <tbody> <tr> <td>1</td> <td>Pull up 3.3V</td> </tr> <tr> <td>2</td> <td>GND</td> </tr> <tr> <td>3</td> <td>Pull up 3.3V</td> </tr> <tr> <td>4</td> <td>Ribbon encoder sensor receiver</td> </tr> </tbody> </table>	Pin	Description	1	Pull up 3.3V	2	GND	3	Pull up 3.3V	4	Ribbon encoder sensor receiver
Pin	Description											
1	Pull up 3.3V											
2	GND											
3	Pull up 3.3V											
4	Ribbon encoder sensor receiver											

Connector	Description	Remark
23	Paper sensor connector	

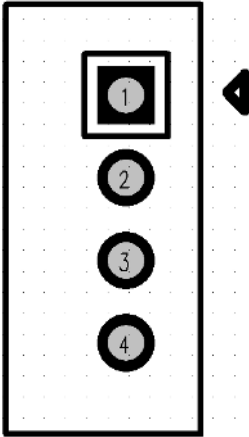
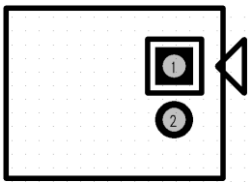
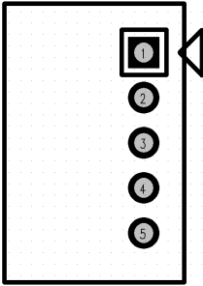
			Pin	Description		
			1	3.3V		
			2	Gap sensor receiver AD		
			3	Black mark sensor emitter		
			4	Black mark sensor receiver		
	RTC Battery connector					
24			Pin	Description		
			1	RTC 3V		
			2	GND		
	Peel sensor & Cutter ID connector					
25			Pin	Description		
			1	3.3V		
			2	SCL		
			3	SDA & Peel sensor emitter		
			4	Peel sensor emitter		
			5	GND		

Connector	Description	Remark
26	Cutter connector	

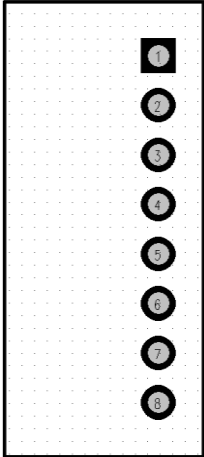
			Pin	Description
			1	24V
			2	GND
			3	PHASE
			4	Cutter enable
			5	Cutter sensor
			6	GND
			7	5V
			8	FGND

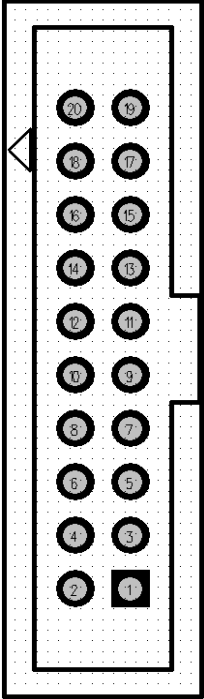
27	TX610 TPH connector			
			Pin	Description
			1	5V
			2	5V
			3	GND
			4	GND
			5	GND
			6	Clock
			7	Latch
			8	TPH ID
			9	Strobe1
			10	Strobe2
			11	Data1
			12	NC
			13	Data2
			14	NC
			15	Data3

	16	NC
	17	Data4
	18	NC
	19	Data5
	20	Temperature sensor

Connector	Description		Remark																												
28	TX210/TX310 TPH connector																														
		<table border="1"> <thead> <tr> <th>Pin</th> <th>Description</th> </tr> </thead> <tbody> <tr> <td>1</td> <td>TPH 24V</td> </tr> <tr> <td>2</td> <td>TPH 24V</td> </tr> <tr> <td>3</td> <td>TPH 24V</td> </tr> <tr> <td>4</td> <td>TPH 24V</td> </tr> <tr> <td>5</td> <td>GND</td> </tr> <tr> <td>6</td> <td>GND</td> </tr> <tr> <td>7</td> <td>Strobe2</td> </tr> <tr> <td>8</td> <td>Data2</td> </tr> <tr> <td>9</td> <td>TPH ID</td> </tr> <tr> <td>10</td> <td>Temperature sensor</td> </tr> <tr> <td>11</td> <td>5V</td> </tr> <tr> <td>12</td> <td>GND</td> </tr> <tr> <td>13</td> <td>Strobe1</td> </tr> </tbody> </table>	Pin	Description	1	TPH 24V	2	TPH 24V	3	TPH 24V	4	TPH 24V	5	GND	6	GND	7	Strobe2	8	Data2	9	TPH ID	10	Temperature sensor	11	5V	12	GND	13	Strobe1	
Pin	Description																														
1	TPH 24V																														
2	TPH 24V																														
3	TPH 24V																														
4	TPH 24V																														
5	GND																														
6	GND																														
7	Strobe2																														
8	Data2																														
9	TPH ID																														
10	Temperature sensor																														
11	5V																														
12	GND																														
13	Strobe1																														

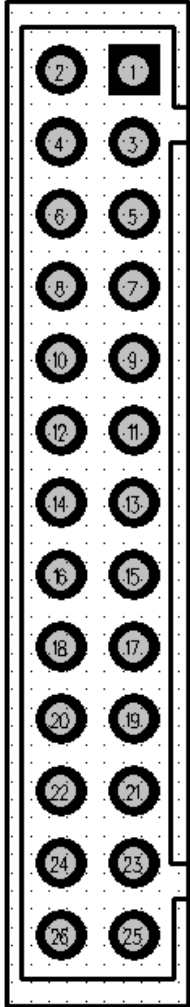
	14	GND	
	15	Clock	
	16	GND	
	17	GND	
	18	GND	
	19	Data1	
	20	Latch	
	21	GND	
	22	GND	
	23	TPH 24V	
	24	TPH 24V	
	25	TPH 24V	
	26		TPH 24V

Connector	Description	Remark
29	TX610 TPH Power connector	

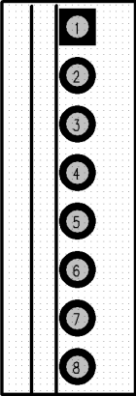
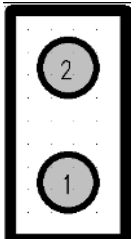
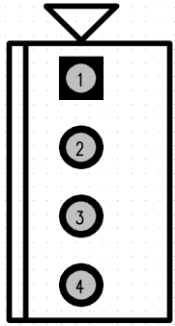
			Pin	Description	
			1	GND	
			2	GND	
			3	GND	
			4	GND	
			5	TPH 24V	
			6	TPH 24V	
			7	TPH 24V	
			8	TPH 24V	
	Motor's ESD Cable connector				
30			Pin	Description	
			1	GND	
			2	GND	
	Motor connector				
31			Pin	Description	
			1	AOUT1	
			2	AOUT2	
			3	BOUT2	
			4	BOUT1	
32	LCD Connector				

2.2 Interface Pin Configuration

RS-232C

PIN	CONFIGURATION
1	+5 V
2	TXD
3	RXD
4	CTS
5	GND
6	RTS
7	N/C
8	RTS
9	N/C

USB Device

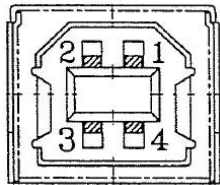

PIN	CONFIGURATION
1	N/C
2	D-
3	D+
4	GND

USB Host

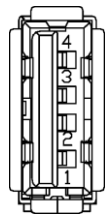

PIN	CONFIGURATION
1	5V
2	D-
3	D+
4	GND

Ethernet

PIN	CONFIGURATION
1	Tx+
2	Tx-
3	Rx+
4	N/C
5	N/C
6	Rx-
7	N/C
8	N/C

Cutter/peel-off Sensor Connector

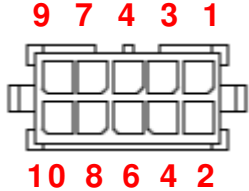
	Pin	Description	Voltage
	1	Cutter enable	0V: Cutter work 5V: Cutter stop
	2	Cutter direction	0V: Cutter positive cut 5V: Cutter negative cut
	3	Cutter position sensor switch	0V: Cutter stop 3.3V: Cutter work
	4	Peel sensor receiver	A/D: 0~3.3V
	5	N/A	N/A
	6	Logic power	5V
	7	GND	0V
	8	Cutter power	24V
	9	I2C SCL signal	
10	I2C SDA signal		

3. Mechanism

3.1 Remove the Lower Cover

1. Open the printer's top cover by pulling the top cover open levers located on each side of the printer and lifting the top cover to the maximum open angle and remove two screws on the lower inner cover.

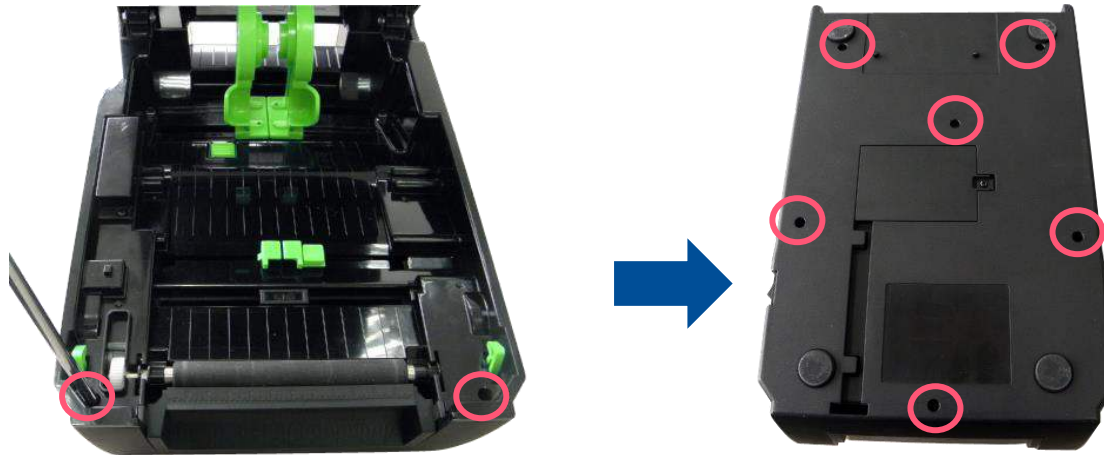

2. Remove/Replace the lower cover.



3. Reassemble the parts in the reverse procedure.

3.2 Remove the Mainboard

1. Please refer to the section 3.1 to remove the lower cover.



2. Remove two screws on the main board.
3. Disconnect all connectors on the main board.
4. Remove/Replace the main board assembly.

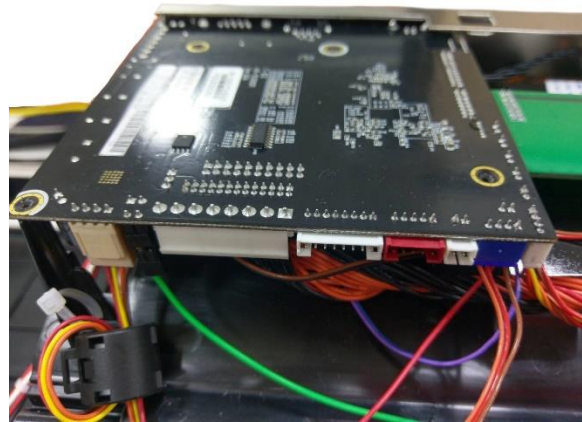
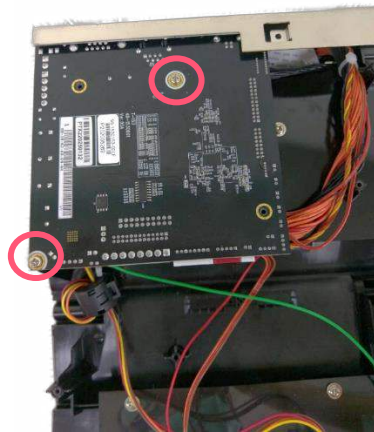

5. Reassemble the parts in the reverse procedure.

3.3 Replacing the Stepping Motor Module

1. Please refer to the section 3.1 to remove the lower cover.
2. Remove three screws as shown.
3. Remove four screws as shown.
4. Remove the hook module assembly.

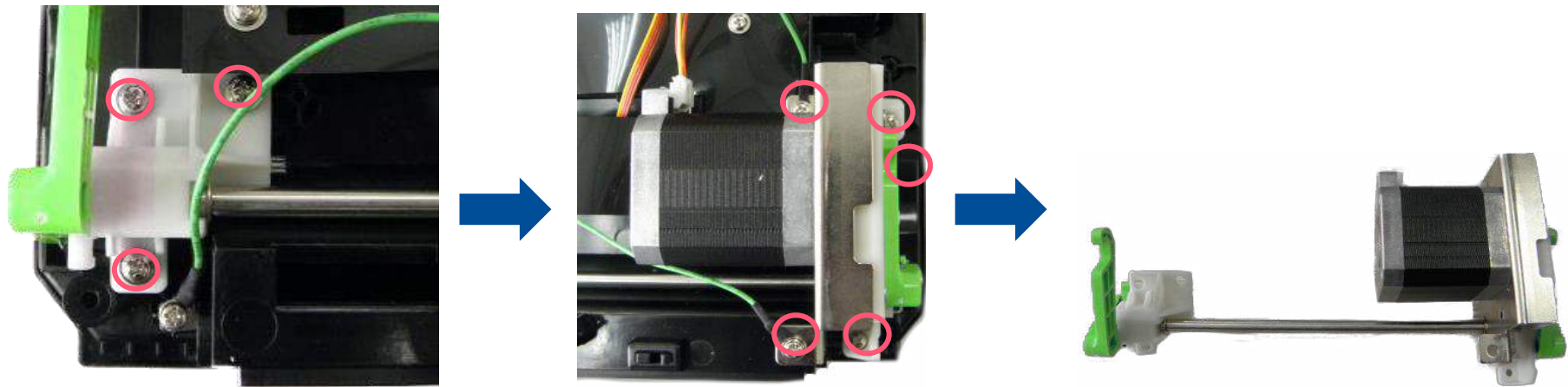

5. Remove one e-ring to replace stepping motor module.



6. Reassemble the parts in the reverse procedure.

3.4 Replacing the Black-mark Sensor Module

1. Please refer to the section 3.3 to remove the hook module assembly.
2. Remove three screws to take out the black mylar.

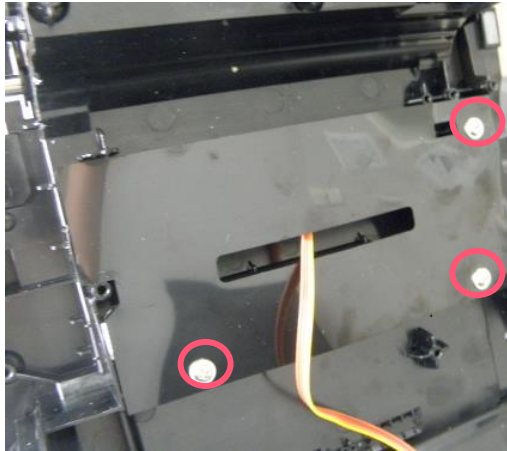

3. Remove two screws on the black-mark sensor fixing plate.

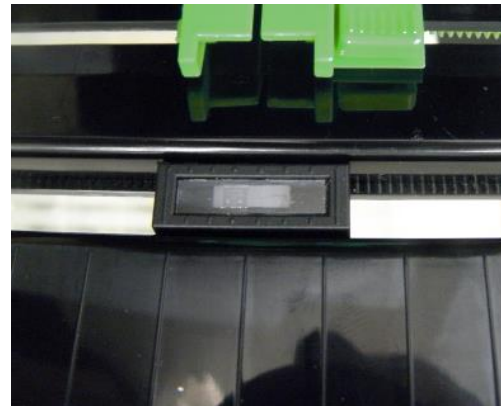
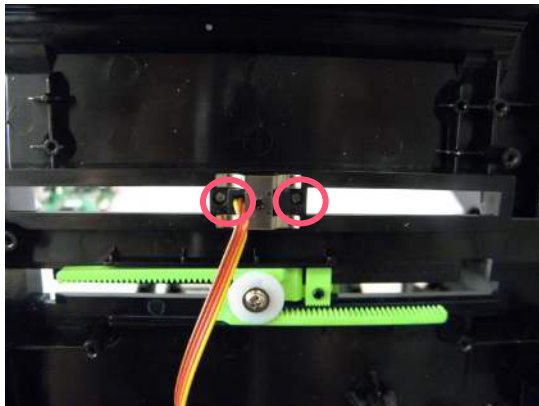

4. Remove/replace the black-mark sensor module.
5. Reassemble the parts in the reverse procedure.

3.5 Replacing the Media Guide Assembly

1. Replacing the Media Guide Assembly Please refer to the section 3.3 to remove the hook module assembly.
2. Refer section 3.4 to remove three screws to take out the black mylar.
3. Remove one screw on the label guide assembly.

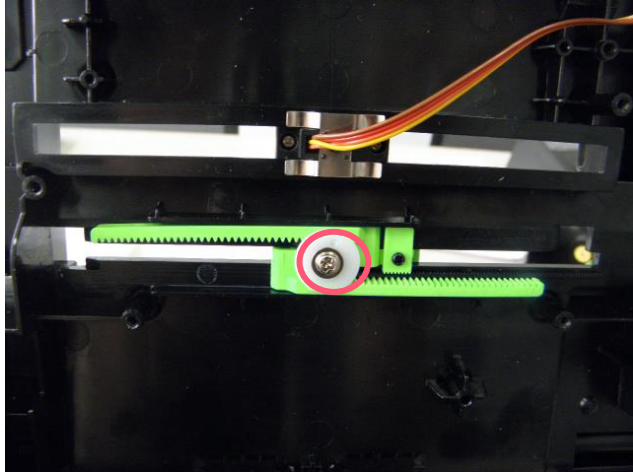

4. Remove/replace the media guide assembly.

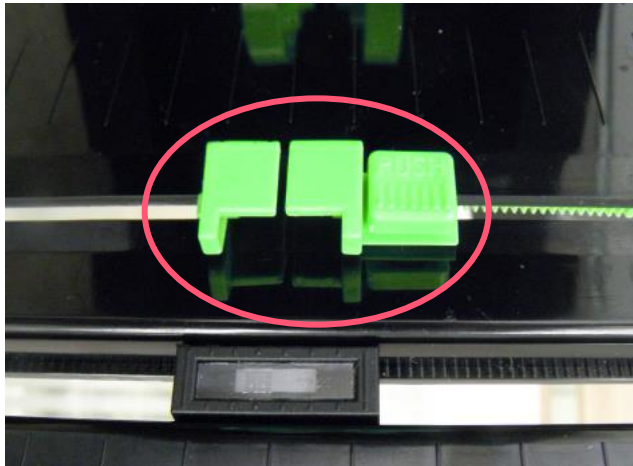

5. Reassemble the parts in the reverse procedure.

3.6 Replacing the Media holder assembly

1. Please refer to section 3.2 to remove the main board.
2. Remove 2 screws to take out the black mylar.

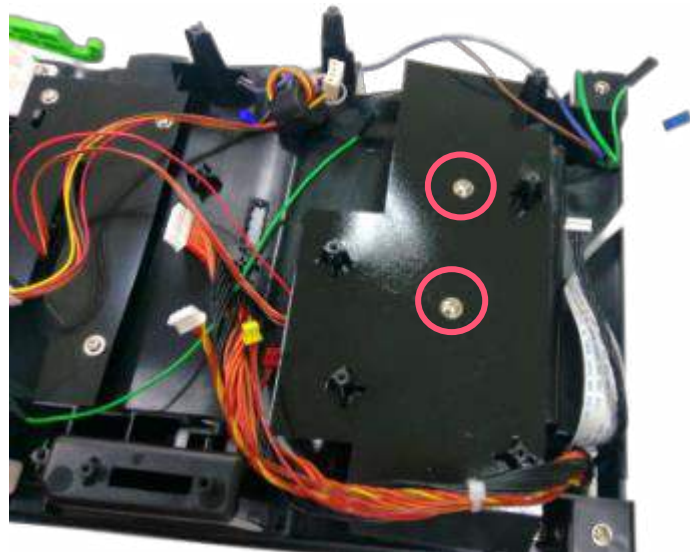

3. Remove the cover as shown.

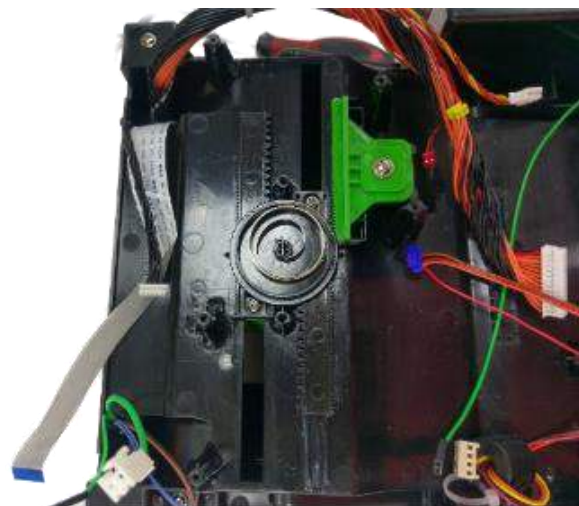
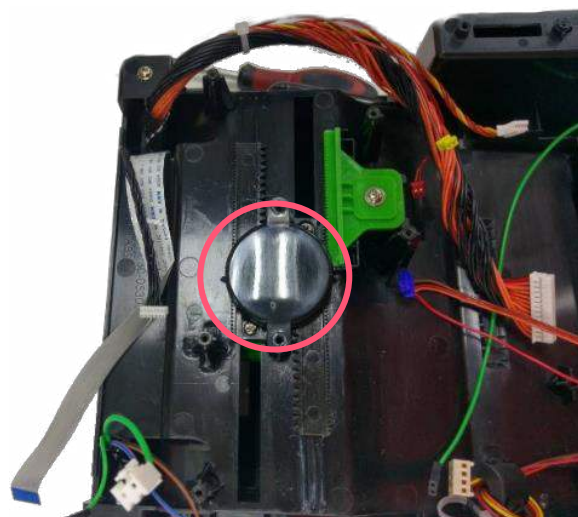

4. Use tool to loose the spiral spring then take out it.

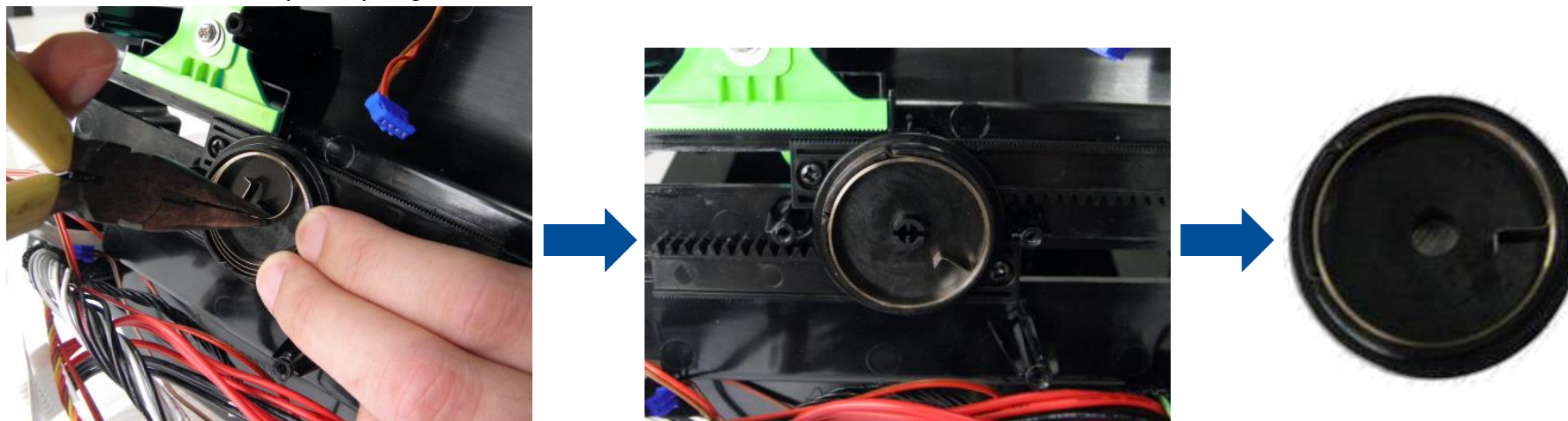

5. Remove four screws to replace the media holder assembly.

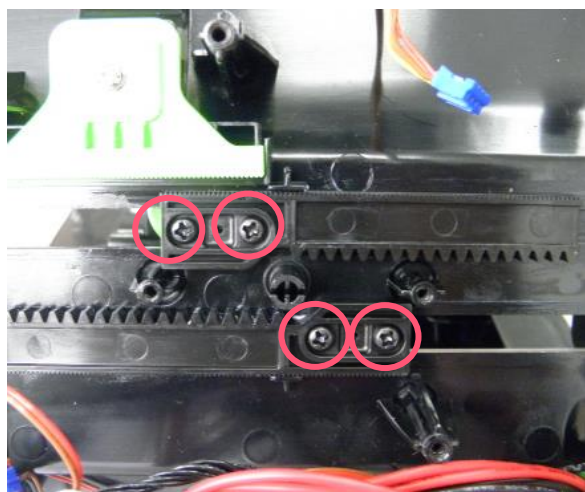

6. Reassemble the parts in the reverse procedure.

3.7 Replacing the LED/LCD module

1. Please refer to the section 3.2 to remove the main board.
2. Remove four screws to take out the lower inner cover assembly.

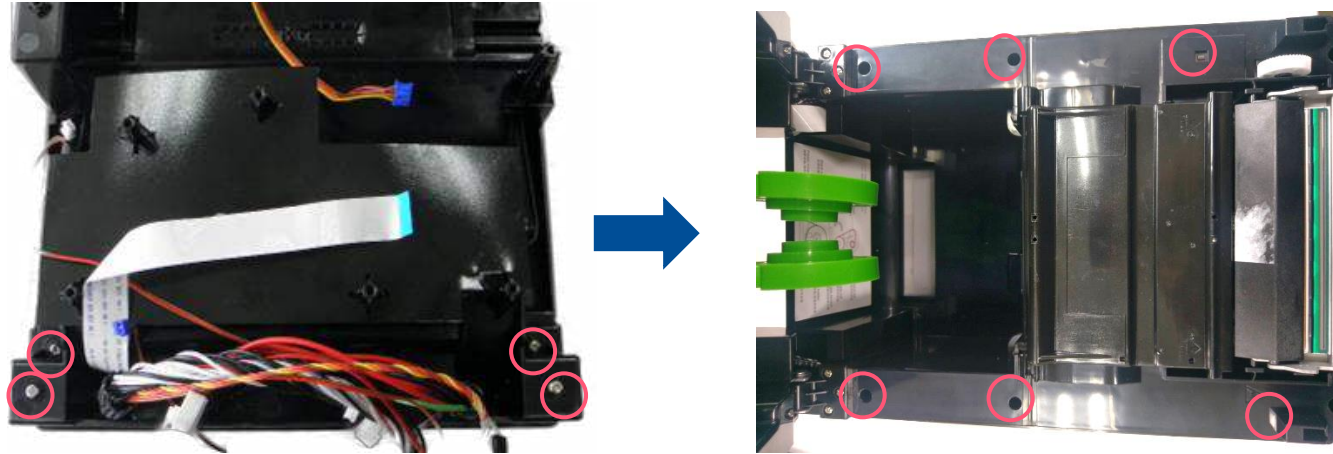

3. Remove 6 screws to remove top cover assembly.
4. Remove 4 screws to remove/replace LED/LCD module.
5. Reassemble the parts in the reverse procedures.

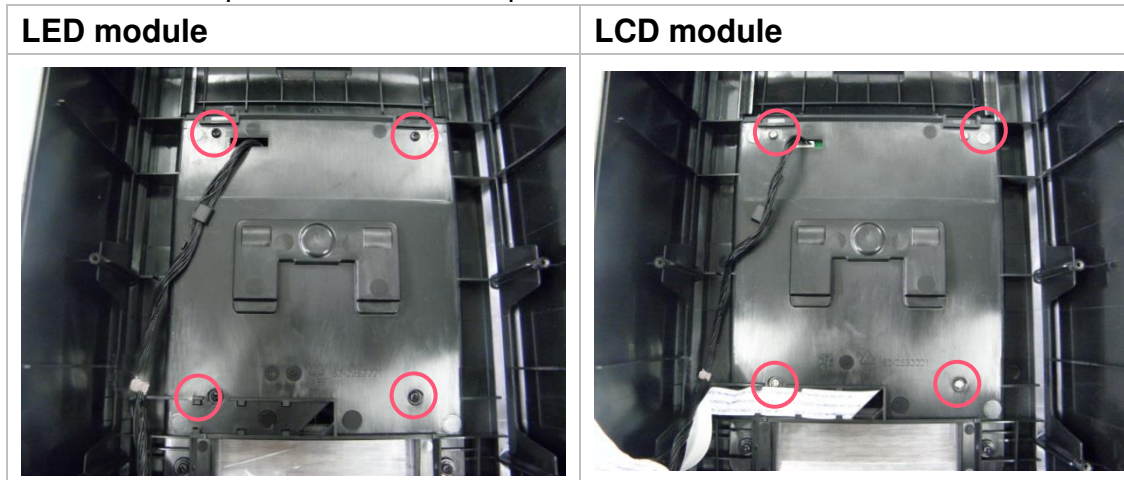

3.8 Replacing the Ribbon Base Module

1. Please refer to the section 3.7 to remove top cover assembly.

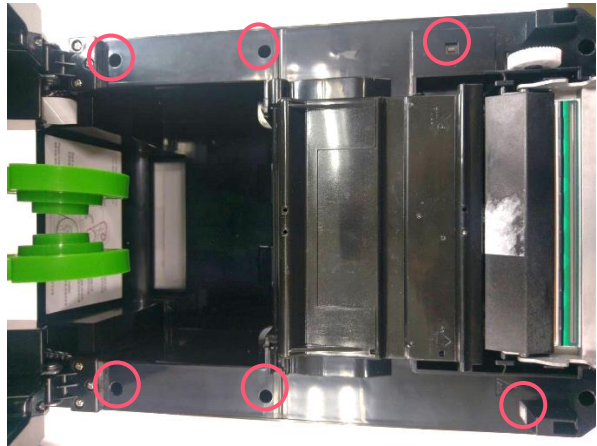

2. Remove the 10 screws on the ribbon base module.

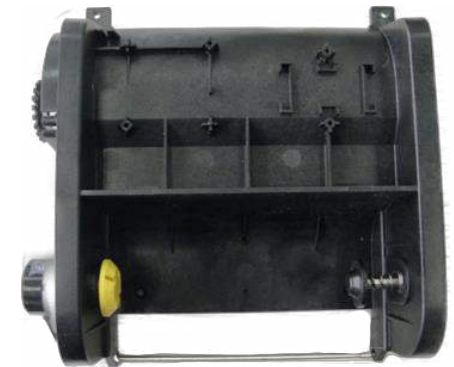
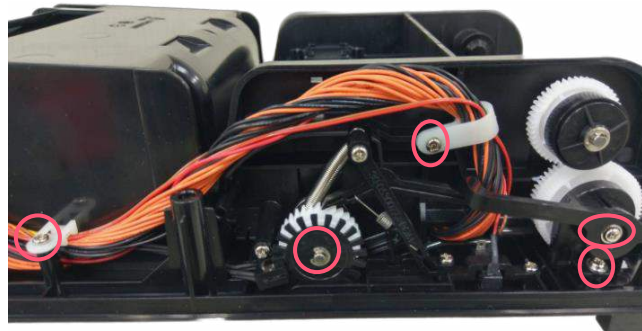

3. Remove/Replace the ribbon base module.
4. Reassemble the parts in the reverse procedure.

3.9 Replacing the Printhead Module

1. Open the printer cover.



2. Open ribbon access cover and media cover.
3. Peel the tab as picture shown to remove the printhead module.

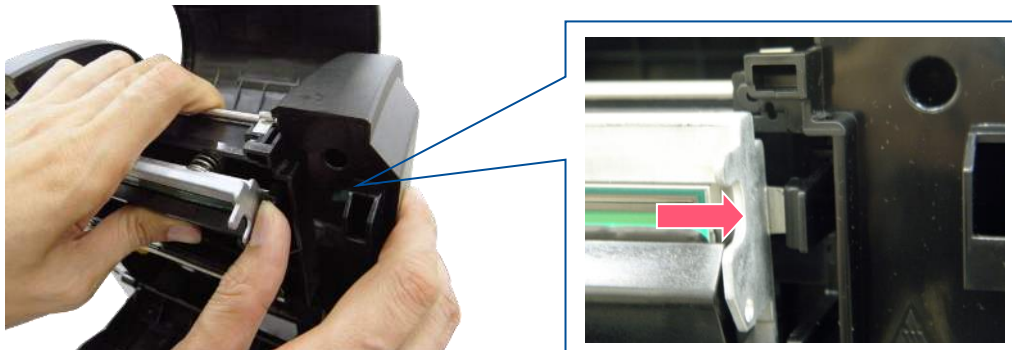

4. Disconnect printhead harness and ground cable to replace the printhead module.

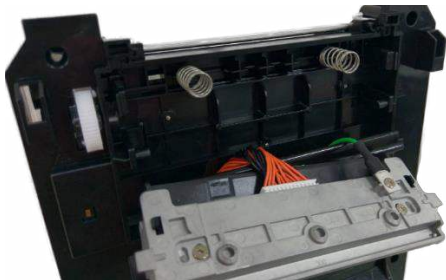

Note: There are 2 harnesses for TX600 series printhead module.

3.10 Replacing the Platen Roller assembly

1. Open the printer cover to remove the lower front panel.

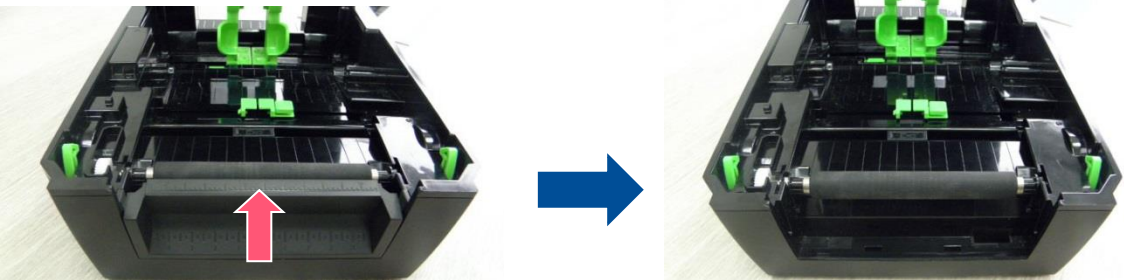

2. Disengage the platen holder tabs by pulling out the right side and left side tabs. Rotate the tabs into the forward position. (see picture below)



3. Take out the platen roller assembly to replace. Reassemble the parts in the reverse procedure.

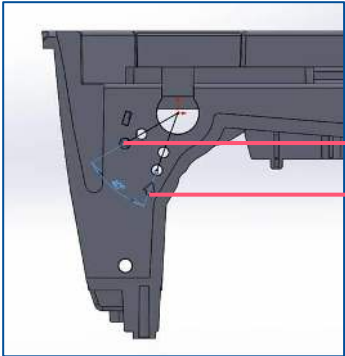

Note:

The tab here is for thick label. (Thickness is 0.19 mm)
The tab here is for regular label.

3.11 Cutter Module Installation (Option)

1. Open the printer cover to remove the lower front panel.
2. Put the cutter module harness through the slot of the lower inner cover front side.
3. Gently place the cutter module into the both sides of niches on lower inner cover, then push cutter to lock into the lower inner cover.

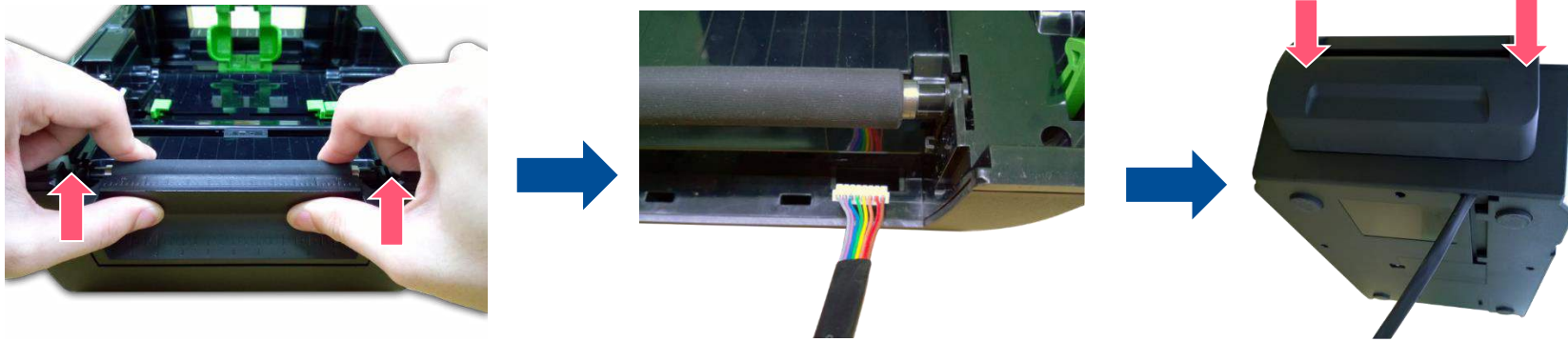

4. Unscrew one screw on the printer bottom cover.
5. Hook the cutter module harness onto the printer lower cover. Plug-in the cutter module harness connector to the 8-pin white socket on the main board.
6. Screw back the screw on the printer bottom cover.



7. The cutter module is ready to use.

Note:

* Except for the linerless cutter, all regular/ heavy duty/ care label cutters DO NOT cut on media with glue. For more details, please refer to the cutter specification in the user's manual.

3.12 Peel-off Module Installation (Option)

1. Remove nine screws on lower inner cover and lower cover as shown.

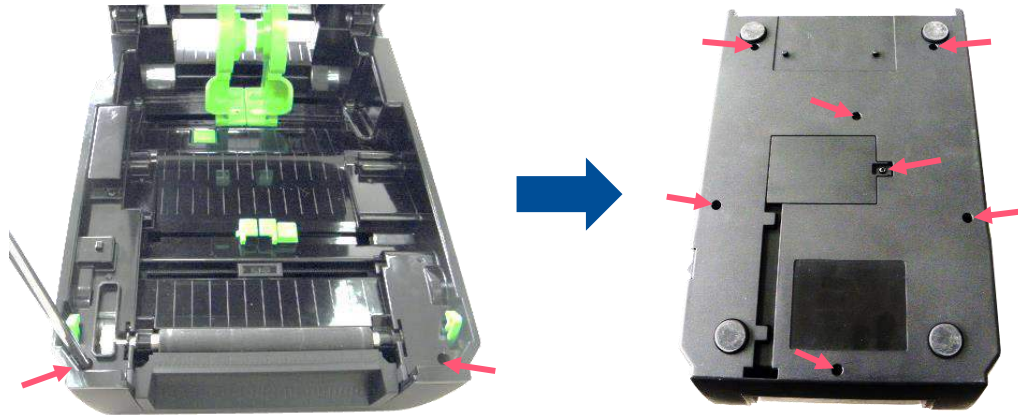

2. After removing the lower cover, remove two screws securing the main board on the lower inner cover. (no need to disconnect all the cables on the main board)

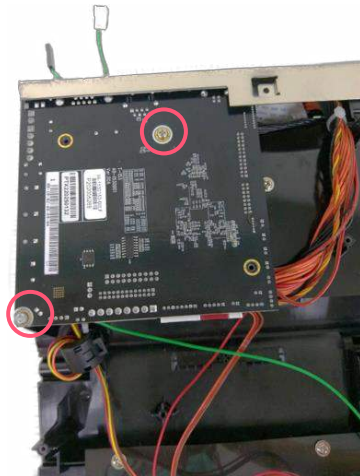

- 3.** Disconnect the grounding connector next to the DC jack. Plug the peel-off bar grounding cable pin into the same connector. Connect back to the main board and secure the main board back by two screws.

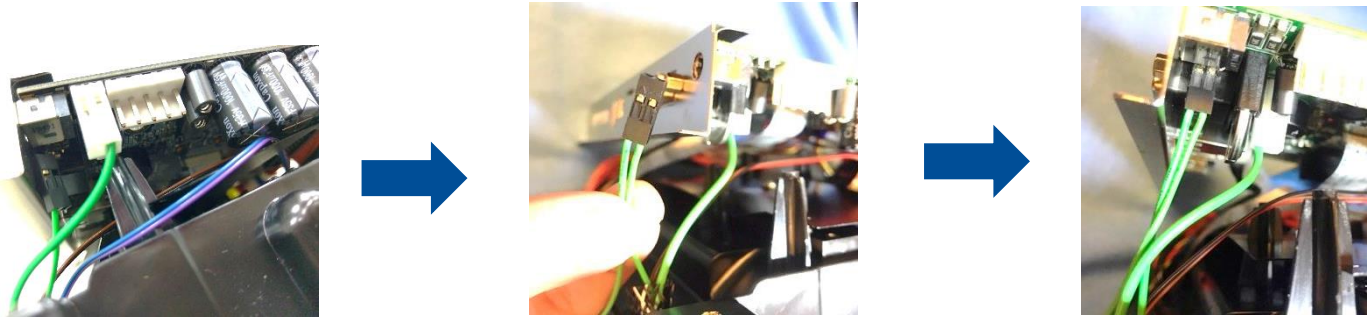

- 4.** Install the lower cover by eight screws then pull the grounding cable through the opening. Put the grounding cable through the slot of the lower cover.

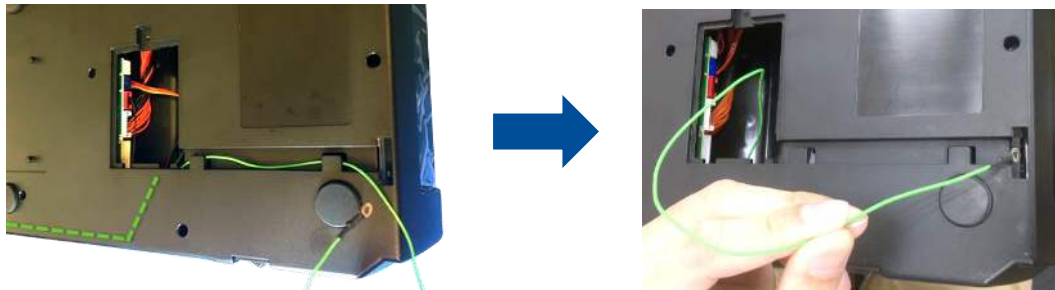

- 5.** Open the printer top cover then open the print head mechanism. Remove the lower front panel.

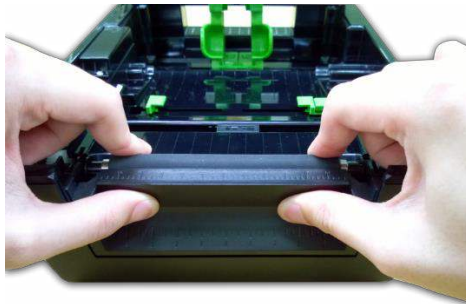

6. Hold the grounding cable onto the right side of the peel-off bar. Then, install the peel-off bar into both slots on front inner lower cover. Please install left side (with spring) first. **Make sure the flat side of grounding wire is on right side as shown below.**

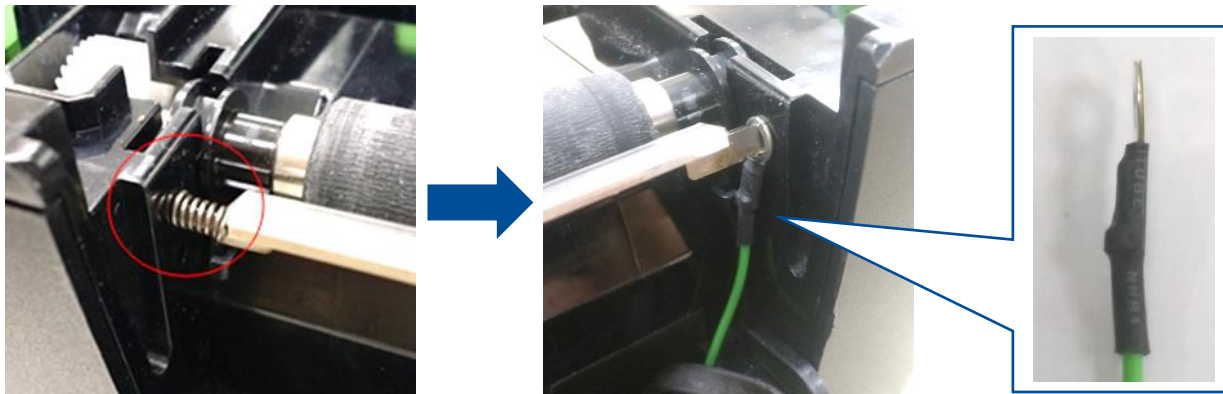

7. Put the peel-off module harness through the slot of the lower inner cover front side.
8. Install the peel-off panel by putting the both sides of tabs into the holes on front inner printer.



9. Plug-in the peel-off module harness connector to the 5-pin red socket on the main board.



10. Hook peel-off module harness and grounding cable onto the printer lower cover. Secure back the printer bottom cover by one screw.

Note: The grounding cable is placed as shown below in dotted line.



3.13 Slot-in Wireless Interface Board Installation (Option)

1. Please refer to the section 3.1 to remove the lower cover.
2. Please check the main board if there is a black connector (as picture shown) for wireless interface board.
3. If there is no black connector on main board for wireless interface board, please remove 2 screws to replace the main board for wireless module.

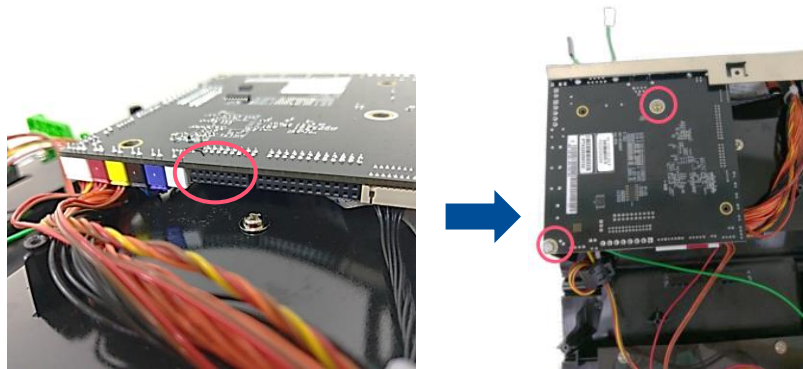

4. Install the wireless interface board into the main board.
5. Fasten 3 screws to fix wireless interface board. Reassemble the parts in the reverse procedures.

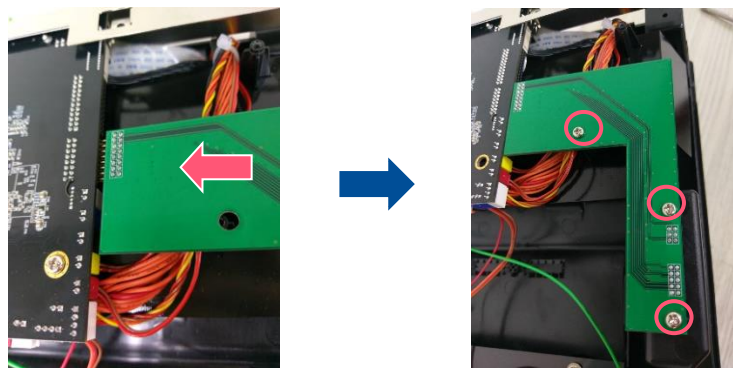





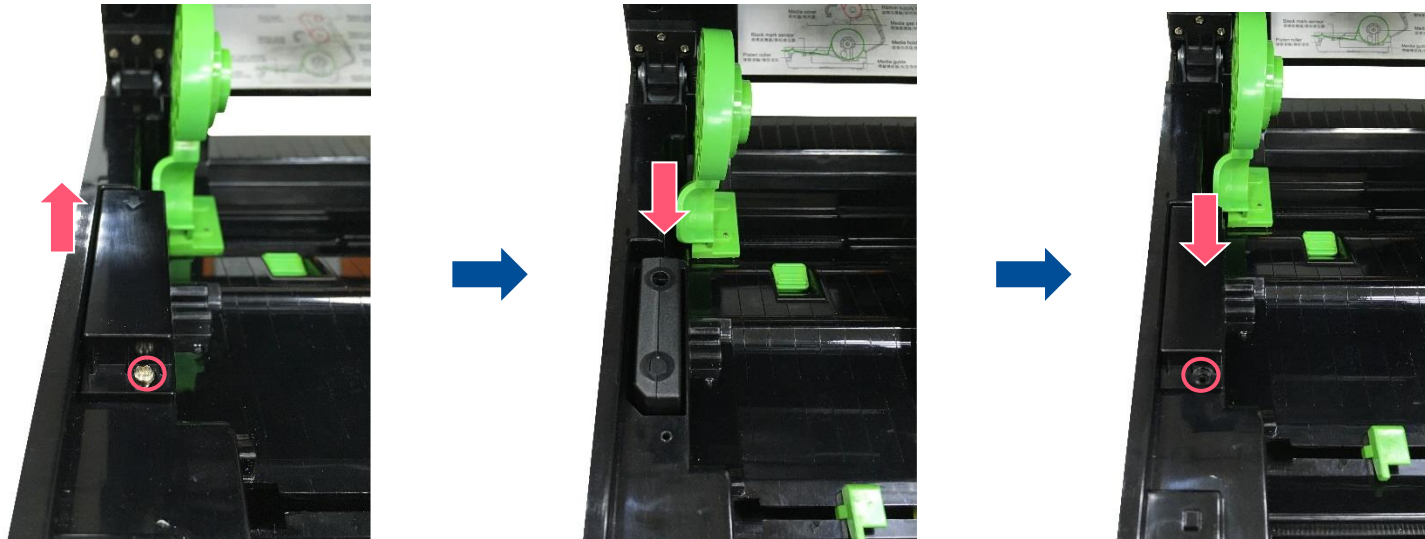

3.14 Slot-in Wi-Fi module Installation (Option)

1. Remove the screw and open the Wi-Fi module cover as indicated.
2. Replace the Wi-Fi module in the slot. (Please push down the module until it is fixed.)
3. Close the cover and fix the screw to complete the Wi-Fi module installation



4. Troubleshooting

4.1 Common issues

Problem	Possible Cause	Recovery Procedure
 Power indicator does not illuminate	<ul style="list-style-type: none"> * The power cord is not properly connected. 	<ul style="list-style-type: none"> * Plug the power cord in printer and outlet. * Switch the printer on.
 LED turn on (Carriage Open)	<ul style="list-style-type: none"> * The printer head is open. 	<ul style="list-style-type: none"> * Please close the print carriages.
 LED turn on (No Ribbon)	<ul style="list-style-type: none"> * Running out of ribbon. * The ribbon is installed incorrectly. 	<ul style="list-style-type: none"> * Supply a new ribbon roll. * Please refer to the steps on section 3.2 to re-install the ribbon.
 LED Blinking	<ul style="list-style-type: none"> * Ribbon near end 	<ul style="list-style-type: none"> * Supply a new ribbon roll.
 LED turn on (No Paper)	<ul style="list-style-type: none"> * Running out of label. * The label is installed incorrectly. * Gap/black mark sensor is not calibrated. 	<ul style="list-style-type: none"> * Supply a new label roll. * Please refer to the steps on section 3.3 to reinstall the label roll. * Calibrate the gap/black mark sensor.
 LED Blinking (Paper jam)	<ul style="list-style-type: none"> * Gap/black mark sensor is not set properly. * Make sure label size is set properly. * Labels may be stuck inside the printer mechanism. 	<ul style="list-style-type: none"> * Calibrate the media sensor. * Set media size correctly. * Remove the stuck label inside the printer mechanism.
 LED turn on (Other errors)	<ul style="list-style-type: none"> * Out of memory * Print head over heat * Cutter error/ Cutter jam * Check if interface cable is well connected to the interface connector. * Check if wireless or Bluetooth device is well connected between host and printer. 	<ul style="list-style-type: none"> * Delete unused files in the FLASH/DRAM. * Wait for print head to cool down. * Remove the stuck label inside the cutter module. * Re-connect cable to interface or change a new cable. * If using serial cable, <ul style="list-style-type: none"> - Please replace the cable with pin to pin connected.
Not Printing		

* The port specified in the Windows driver is not correct.

- Check the baud rate setting. The default baud rate setting of printer is 9600,n,8,1.

* If using the Ethernet cable,

- Check if the Ethernet RJ-45 connector green LED is lit on.

- Check if the Ethernet RJ-45 connector amber LED is blinking.

- Check if the printer gets the IP address when using DHCP mode.

- Check if the IP address is correct when using the static IP address.

- Wait a few seconds let the printer get the communication with the server then check the IP address setting again.

* Please reset the wireless device setting.

* Select the correct printer port in the driver.

* Print head's harness connector is not well connected with printhead. Turn off the printer and plug the connector again.

* Check your program if there is a command PRINT at the end of the file and there must have CRLF at the end of each command line.

* Follow the instructions in loading the media and ribbon.

* Ribbon and media are not compatible.

* Verify the ribbon-inked side.

* The print density setting is incorrect.

* Clean the print head.

* Reload the supply.

* Clean the print head.

* Clean the platen roller.

* Adjust the print density and print speed.

* Run printer self-test and check the print head test pattern if there is dot missing in the pattern.

* Change proper ribbon or proper label media.

* The release lever does not latch the print head properly.

* If the peeler module is installed, please remove the label.

* If there is no peeler module in front of the printer, please switch off the printer and install it.

* Check if the connector is plugging correctly.

No print on the label

* Label or ribbon is loaded not correctly.

* Use wrong type paper or ribbon

Poor Print Quality

* Ribbon and media is loaded incorrectly

* Dust or adhesive accumulation on the print head.

* Print density is not set properly.

* Print head element is damaged.

* Ribbon and media are incompatible.

* The print head pressure is not set properly.

Take Label

* Peel function is enabled.

Cutter is not working	<ul style="list-style-type: none"> * The connector is loose. * Cutter jam. * Cutter PCB is damaged. 	<ul style="list-style-type: none"> * Plug in the connect cable correctly. * Remove the label. * Make sure the thickness of label is less than 0.19 mm. * Replace a cutter driver IC board.
Can't downloading the file to memory (FLASH / DRAM/CARD)	<ul style="list-style-type: none"> * The space of memory is full. 	<ul style="list-style-type: none"> * Delete unused files in the memory.
SD card is unable to use	<ul style="list-style-type: none"> * SD card is damaged. * SD card doesn't insert correctly. * Use the non-approved SD card manufacturer. 	<ul style="list-style-type: none"> * Use the supported capacity SD card. * Insert the SD card again. * The supported SD card spec and the approved SD card manufacturers, please refer to section 2.2.3.
Missing printing on the left or right side of label	<ul style="list-style-type: none"> * Wrong label size setup. 	<ul style="list-style-type: none"> * Set the correct label size.
Gray line on the blank label	<ul style="list-style-type: none"> * The print head is dirty. * The platen roller is dirty. 	<ul style="list-style-type: none"> * Clean the print head. * Clean the platen roller.
Irregular printing	<ul style="list-style-type: none"> * The printer is in Hex Dump mode. * The RS-232 setting is incorrect. 	<ul style="list-style-type: none"> * Turn off and on the printer to skip the dump mode. * Re-set the Rs-232 setting.
Label feeding is not stable (skew) when printing	<ul style="list-style-type: none"> * The media guides do not touch the edge of the media. 	<ul style="list-style-type: none"> * If the label is moving to the right side, please move the label guide to left. * If the label is moving to the left side, please move the label guide to right.
Skip labels when printing	<ul style="list-style-type: none"> * Label size is not specified properly. * Sensor sensitivity is not set properly. * The media sensor is covered with dust. * Printhead pressure is incorrect. * Ribbon installation is incorrect. * Media installation is incorrect. * Print density is incorrect. * Media feeding is incorrect. 	<ul style="list-style-type: none"> * Check if label size is setup correctly. * Calibrate the sensor by Auto Gap or Manual Gap options. * Clear the GAP/Black mark sensor by blower.
Wrinkle Problem	<ul style="list-style-type: none"> * Media sensor sensitivity is not set properly. * Label size is incorrect. * The parameter Shift Y is incorrect. * The vertical offset setting in the driver is incorrect. 	<ul style="list-style-type: none"> * Please set the suitable density to have good print quality. * Make sure the label guides touch the edge of the media guide.
RTC time is incorrect when reboot the printer	<ul style="list-style-type: none"> * The battery has run down. 	<ul style="list-style-type: none"> * Check if there is a battery on the main board.
The printing position of small label is incorrect	<ul style="list-style-type: none"> * Media sensor sensitivity is not set properly. * Label size is incorrect. * The parameter Shift Y is incorrect. * The vertical offset setting in the driver is incorrect. 	<ul style="list-style-type: none"> * Calibrate the sensor sensitivity again. * Set the correct label size and gap size. * Use TSC Console to fine tune the parameter of Shift Y. * If using the software BarTender, please set the vertical offset in the driver.

Maintenance

This session presents the clean tools and methods to maintain the printer.

■ For Cleaning

Depending on the media used, the printer may accumulate residues (media dust, adhesives, etc.) as a by-product of normal printing. To maintain the best printing quality, you should remove these residues by cleaning the printer periodically. Regularly clean the print head and supply sensors once change a new media to keep the printer at the optimized performance and extend printer life.

■ For Disinfecting

Sanitize your printer to protect yourself and others and can help prevent the spread of viruses.

■ Important

- Set the printer power switch to O (Off) prior to performing any cleaning or disinfecting tasks. Leave the power cord connected to keep the printer grounded and to reduce the risk of electrostatic damage.
- Do not wear rings or other metallic objects while cleaning any interior area of the printer.
- Use only the cleaning agents recommended in this document. Use of other agents may damage the printer and void its warranty.
- Do not spray or drip liquid cleaning solutions directly into the printer. Apply the solution on a clean lint-free cloth and then apply the dampened cloth to the printer.
- Do not use canned air in the interior of the printer as it can blow dust and debris onto sensors and other critical components.
- Only use a vacuum cleaner with a nozzle and hose that are conductive and grounded to drain off static build up.
- All reference in these procedures for use of isopropyl alcohol requires that a 99% or greater isopropyl alcohol content be used to reduce the risk of moisture corrosion to the printhead.
- Do not touch printhead by hand. If you touch it carelessly, please use 99% Isopropyl alcohol to clean it.
- Always taking personal precaution when using any cleaning agent.

Cleaning Tools

- Cotton swab
- Lint-free cloth
- Brush with soft non-metallic bristles
- Vacuum cleaner
- 75% Ethanol (for disinfecting)
- 99% Isopropyl alcohol (for printhead and platen roller cleaning)
- Genuine printhead cleaning pen
- Mild detergent (without chlorine)

Cleaning Process:

Printer Part	Method	Interval
Print Head	<ol style="list-style-type: none"> I. Always turn off the printer before cleaning the printhead. II. Allow the printhead to cool for at least one minute. III. Use a cotton swab and 99% Isopropyl Alcohol or genuine print head cleaning pen to clean the print head surface. 	Clean the print head when changing a new label roll.
Platen Roller	<ol style="list-style-type: none"> I. Turn off the printer. II. Rotate the platen roller and wipe it thoroughly with the lint-free 99% Isopropyl Alcohol. 	Clean the platen roller when changing a new label roll
Peel Bar	Use the lint-free cloth with 99% Isopropyl Alcohol to wipe it.	As needed
Sensor	Use brush with soft non-metallic bristles or a vacuum cleaner, to remove paper dust. Clean upper and lower media sensors to ensure reliable Top of Form and Paper Out sensing.	Monthly
Exterior	Clean the exterior surfaces with a clean, lint-free cloth (water-dampened cloth). If necessary, use a mild detergent or desktop cleaning solution then use the 75% Ethanol to wipe it.	As needed
Interior	Clean the interior of the printer by removing any dirt and lint with a vacuum cleaner, as described above, or use a brush with soft non-metallic bristles then use the 75% Ethanol to wipe it.	As needed

Revise History

Date	Content	Editor
------	---------	--------

TSC **PRINTRONIX[®]**
AUTO ID