

MH241 Series

■ Thermal Transfer ■ Direct Thermal
Industrial Barcode Printers



Series Lists:

MH241/MH341/MH641

MH241T/MH341T/MH641T

MH241P/MH341P/MH641P

User Manual

Copyright Information

©2021 TSC Auto ID Technology Co., Ltd.

The copyright in this manual, the software and firmware in the printer described are owned by TSC Auto ID Technology Co., Ltd. All rights reserved.

CG Triumvirate is a trademark of Agfa Corporation. CG Triumvirate Bold Condensed font is under license from the Monotype Corporation. Windows is a registered trademark of Microsoft Corporation.

All other trademarks are the property of their respective owners. Information in this document is subject to change without notice and does not represent a commitment on the part of TSC Auto ID Technology Co. No part of this manual may be reproduced or transmitted in any form or by any means, for any purpose other than the purchaser's personal use, without the expressed written permission of TSC Auto ID Technology Co.



Table of Contents

1. Introduction	1
1.1 Product Specification	2
2. Operation Overview	6
2.1 Unpacking and Inspection	6
2.2 Printer Overview	7
2.2.1 Front View	7
2.2.2 Interior View	8
2.2.3 Rear View	10
2.3 Operator Control	10
2.3.1 LED Indication and Keypads	11
2.3.2 Touch Screen Manipulation	14
2.3.3 Power-on Utilities	15
3. Setup	16
3.1 Setting up the printer	16
3.2 Loading the Ribbon	17
3.3 Loading the Media	19
3.4 Loading the Fanfold/External Media	21
3.5 Loading Media in Peel-off Mode (Option)	22
3.6 Loading Media in Rewinder Mode (Option-MH241P)	23

3.7 Loading Media in Rewinder Mode (Option-MH241/MH241T)	24
4. Knob Adjustment	25
4.1 Ribbon Tension Adjustment Knob	26
4.2 Mechanism Fine Adjustment to Avoid Ribbon Wrinkles.....	27
5. TSC Console	30
5.1 Start TSC Console	30
5.2 Setup Ethernet Interface	32
5.3 Set WiFi and Add to TSC Console Interface	34
5.4 Initialize the Printer WiFi Setting	37
5.5 TPH Care.....	38
5.6 Printer Function	39
5.7 Setting Post-Print Action	40
6. LCD Menu Function.....	41
6.1 Enter the Menu	41
6.2 Menu Overview	42
6.3 Setting	43
6.3.1 TSPL	44
6.3.2 ZPL2	46
6.4 Sensor	49



6.5 Interface.....50

- 6.5.1 Serial Comm.....51
- 6.5.2 Ethernet.....52
- 6.5.3 Wi-Fi.....53
- 6.5.4 Bluetooth.....54

6.6 Advanced.....55

6.7 File Manager.....57

6.8 Diagnostic.....58

6.9 Favorites.....59

7. TroubleShooting.....60

8. Maintenance.....63

9. Agency Compliance and Approvals.....65

10. Revise History.....72

1. Introduction

Thank you very much for purchasing TSC bar code printer.

The new high-performance MH241Series was designed to deliver the high quality barcodes. It features a die-cast print mechanism housed in a very strong yet lightweight cabinet. This new design results in a more durable printer that is suited for your most heavy-duty demand cycles. The MH241 Series printers are loaded with standard features including a color touch display with brand-new GUI design and six menu buttons to provide a great user experience, support for 600 meter long ribbons, 8" OD media rolls, built-in Ethernet, RS-232 interface, two USB hosts for keyboard and barcode scanner connections, USB 2.0 and serial interfaces. Parallel, GPIO ports, WiFi module and internal Bluetooth module are available as an option.

This document provides an easy reference for operating the MH241 series. TSC printers include the Windows labeling software for creating your label template. For system integration, the TSPL/TSPL2 printer programming manual or SDKs can be found on TSC website at: <https://www.tscprinters.com>.

Applications

- Work In Process
- Product Marking
- Compliance Labeling
- Industrial-Duty Printing
- Packing
- Order Fulfillment
- Shipping/Receiving
- Inventory Management Retail
- Product Label
- Event Ticketing

1.1 Product Specification

Model	STANDARD			Advanced			PREMIUM		
	MH241	MH341	MH641	MH241T	MH341T	MH641T	MH241P	MH341P	MH641P
Resolution	8 dots/mm (203 DPI)	12 dots/mm (300 DPI)	24 dots/mm (600 DPI)	8 dots/mm (203 DPI)	12 dots/mm (300 DPI)	24 dots/mm (600 DPI)	8 dots/mm (203 DPI)	12 dots/mm (300 DPI)	24 dots/mm (600 DPI)
Printing Method	Thermal transfer and direct thermal								
Max. print speed	356 mm (14")/second	305 mm (12")/second	152 mm (6")/second	356 mm (14")/second	305 mm (12")/second	152 mm (6")/second	356 mm (14")/second	305 mm (12")/second	152 mm (6")/second
Max. print width	104 mm(4.09")								
Max. print length	25,400 mm (1000")	11,430 mm (450")	2540 mm (100")	25,400 mm (1000")	11,430 mm (450")	2540 mm (100")	25,400 mm (1000")	11,430 mm (450")	2540 mm (100")
Enclosure	Die-cast print mechanism and base with bi-fold metal cover with large clear media view window								
Physical dimension	276 mm (W) x 326 mm (H) x 502 mm (D) 10.87" (W) x 12.83" (H) x 19.76" (D)			276 mm (W) x 412 mm (H) x 502 mm (D) (D) 10.87" (W) x 16.22" (H) x 19.76" (D)					
Weight	15.35kg (33.84 lbs)			15.43 kg (34.02 lbs)			18.93kg (41.73 lbs)		
Label roll capacity	203.2 mm (8") O.D.								
Internal rewinder (full roll)	Internal rewinding kit (5" O.D.) (dealer option)						Standard (8" O.D.) (With 3" Rewinder I.D)		
Ribbon	600 m long, max. O.D. 90 mm, 1" core (ink coated outside or inside)								

Ribbon width	25.4 mm ~ 114.3 mm (1" ~ 4.5")	
Processor	32-bit RISC CPU	
Memory	<ul style="list-style-type: none"> ■ 512MB Flash memory ■ 256MB DDR2 ■ microSD Flash memory card reader for Flash memory expansion, up to 32 GB 	
TPH feature	<ul style="list-style-type: none"> ■ Support TSC TPH Care and TPH odometer 	
Interface	<ul style="list-style-type: none"> ■ RS-232 ■ USB 2.0 (High speed mode) ■ Internal Ethernet, 10/100 Mbps ■ USB host *2 (Front side), for scanner or PC keyboard ■ GPIO (DB15F) + Centronics (factory option) ■ Internal Bluetooth 5.0 MFi (factory option) ■ Slot-in 802.11 1/b/g/n/ac Wi-Fi + BT combo module kit (dealer option) 	
Power	<p>Internal switching power supply</p> <ul style="list-style-type: none"> ■ Input: AC 100-240V, 4-2A, 50-60Hz ■ Output: DC 5V, 5A; DC 24V, 7A; DC 36V, 1.4A; Total 243W 	
LCD display/ Operation buttons	<ul style="list-style-type: none"> ■ 6 operation buttons (menu, feed/pause, up, down, left, right) ■ 1 LED (with 2 LEDs Green & Red) 	<ul style="list-style-type: none"> ■ Multi-language selectable ■ 6 operation buttons (menu, select, up, down, left/pause, right/feed) ■ 1 LED (with 2 LEDs Green & Red)
LCD	<ul style="list-style-type: none"> ■ 3.5" color display, 320 x 240 pixel 	
Sensors	<ul style="list-style-type: none"> ■ Gap transmissive sensor (position adjustable) ■ Black mark reflective sensor (Bottom or Top black mark sensor switchable and position adjustable) ■ Head open sensor ■ Ribbon encoder sensor 	

	<ul style="list-style-type: none"> ■ Ribbon end sensor
Real time clock	<ul style="list-style-type: none"> ■ Standard
Internal font	<ul style="list-style-type: none"> ■ 8 alpha-numeric bitmap fonts ■ One Monotype Imaging® CG Triumvirate Bold Condensed scalable font ■ Built-in Monotype True Type Font engine
Bar code	<p>1D bar code Code 39, Code 93, Code128UCC, Code128 subsets A.B.C, Codabar, Interleave 2 of 5, EAN-8, EAN-13, EAN-128, UPC-A, UPC-E, EAN and UPC 2(5) digits add-on, MSI, PLESSEY, POSTNET, RSS-Stacked, GS1 DataBar, Code 11, China Post</p> <p>2D bar code PDF-417, Maxicode, DataMatrix, QR code, Aztec</p>
Font & bar code rotation	0, 90, 180, 270 degree
Print language	TSPL-EZD (Compatible to EPL, ZPL, ZPL II, DPL)
Media type	Continuous, die-cut, black mark (Bottom side or top side black mark), fan-fold, notch, perforated, tag, care label (outside wound)
Media width	20 ~ 114 mm (0.79" ~ 4.5")
Media thickness	0.06 ~ 0.28 mm (2.36 ~ 11 mil)
Media core diameter	3.81mm/76.2mm (1.5"/ 3")
Label length	5 ~ 25,400 mm (0.20" ~ 1,000")
Environment condition	<p>Operation: 0 ~ 40°C (32 ~ 104°F), 25~85% non-condensing</p> <p>Storage: -40 ~ 60 °C (-40 ~ 140°F), 10~90% non-condensing</p>

Safety regulation FCC Class A, CE Class A, RCM Class A, UL, cUL, TÜV/safety, CCC, KC, BIS, ENERGY STAR®

Environmental concern Comply with RoHS, WEEE

Accessories

- Windows labeling software CD disk
- Quick start guide
- USB port cable
- Power cord

Factory option

- Regular cutter kit(full cut guillotine cutter)
- Heavy duty cutter kit(full cut guillotine cutter)
- Care label cutter kit
- High speed care label cutter kit
- Rotary heavy duty cutter kit
- 1" I.D. core media spindle kit
- 802.11 a/b/g/n/ac Wi-Fi + BT combo module kit (including slot-in housing)
- Peel-off kit
- Internal rewinding kit (5" O.D.) (With 1" rewinder I.D.)

- 802.11 a/b/g/n/ac Wi-Fi + BT combo module kit

Dealer option

- 802.11 a/b/g/n/ac Wi-Fi + BT combo module
- Cutter catch tray (Basic)
- Cutter catch tray UCT-Basic (Universal cutter catch tray-Basic)
- Cutter catch tray UCT (Universal cutter catch tray)
- KP-200 Plus keyboard display unit

2. Operation Overview

2.1 Unpacking and Inspection

This printer has been specially packaged to withstand damage during shipping. Please carefully inspect the packaging and printer upon receiving the bar code printer. Please retain the packaging materials in case you need to reship the printer.

Unpacking the printer, the following items are included in the carton.

- 1 Printer unit (MH241, MH241T, or MH241P Series)
- 1 Quick installation guide
- 1 Power cord
- 1 USB interface cable

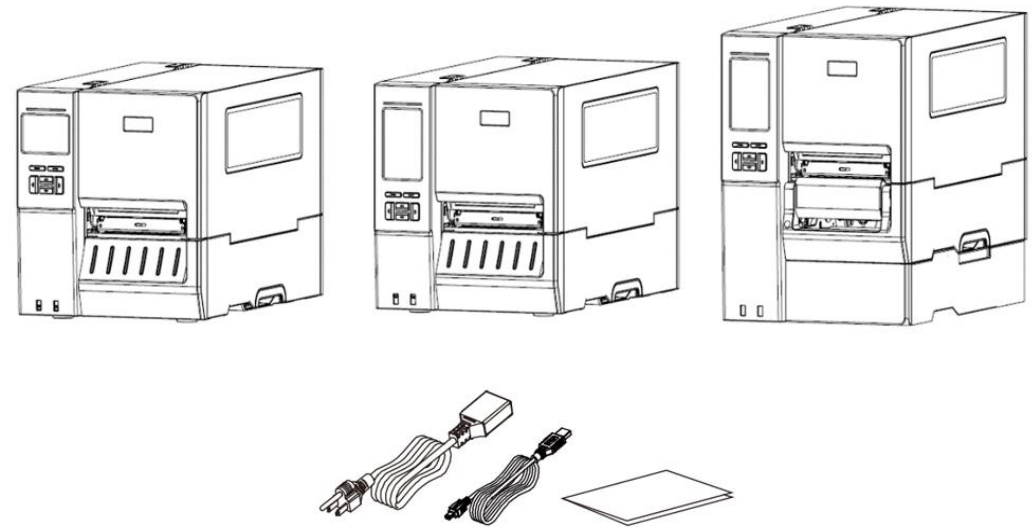

If any parts are missing, please contact the Customer Service Department of your purchased reseller or distributor.

2.2 Printer Overview

2.2.1 Front View

MH241 Series



1. LED indicator
2. LCD display
3. Front panel buttons
4. USB host x 2
5. Media view window
6. Paper exit chute
7. Media cover handle

MH241T Series



1. LED indicator
2. LCD display
3. Front panel buttons
4. USB host x 2
5. Media view window
6. Paper exit chute
7. Media cover handle

MH241P Series



1. LED indicator
2. LCD display
3. Front panel buttons
4. USB host x 2
5. Media view window
6. Paper exit chute
7. Media cover handle
8. Media lower cover

2.2.2 Interior View

MH241/MH241T Series

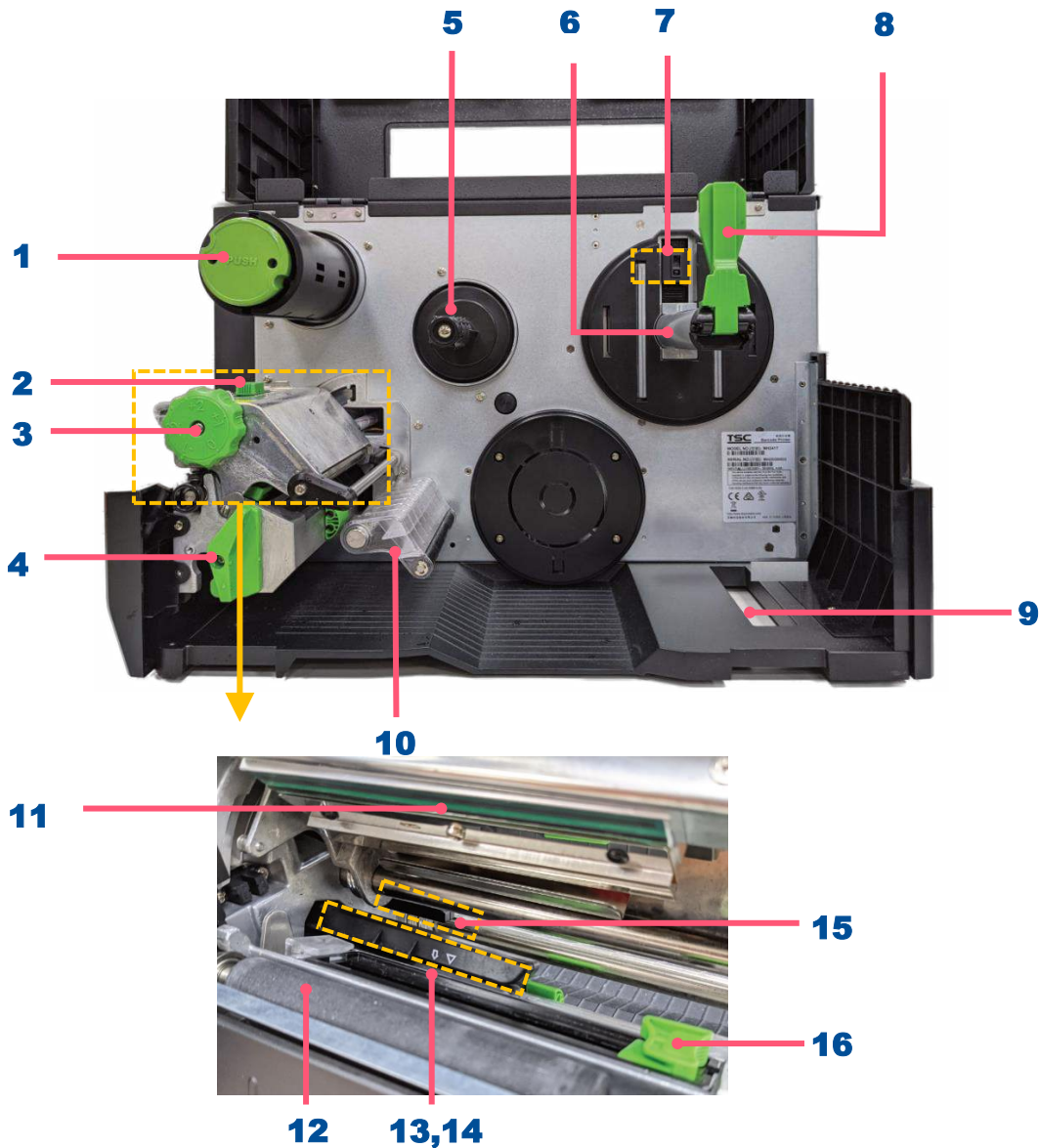

1. Ribbon rewind spindle
2. Print head pressure position adjustment knob
3. Print head pressure adjustment knob
4. Print head release lever
5. Ribbon supply spindle
6. Label supply spindle
7. Media near end sensor (movable, MH241T Series only)
8. Label roll guard
9. External label entrance chute
10. Damper
11. Print head
12. Platen roller
13. Black mark sensor (shown as ↓)
14. Gap sensor (shown as ▽)
15. Ribbon sensor
16. Front label guide

For MH241P Series

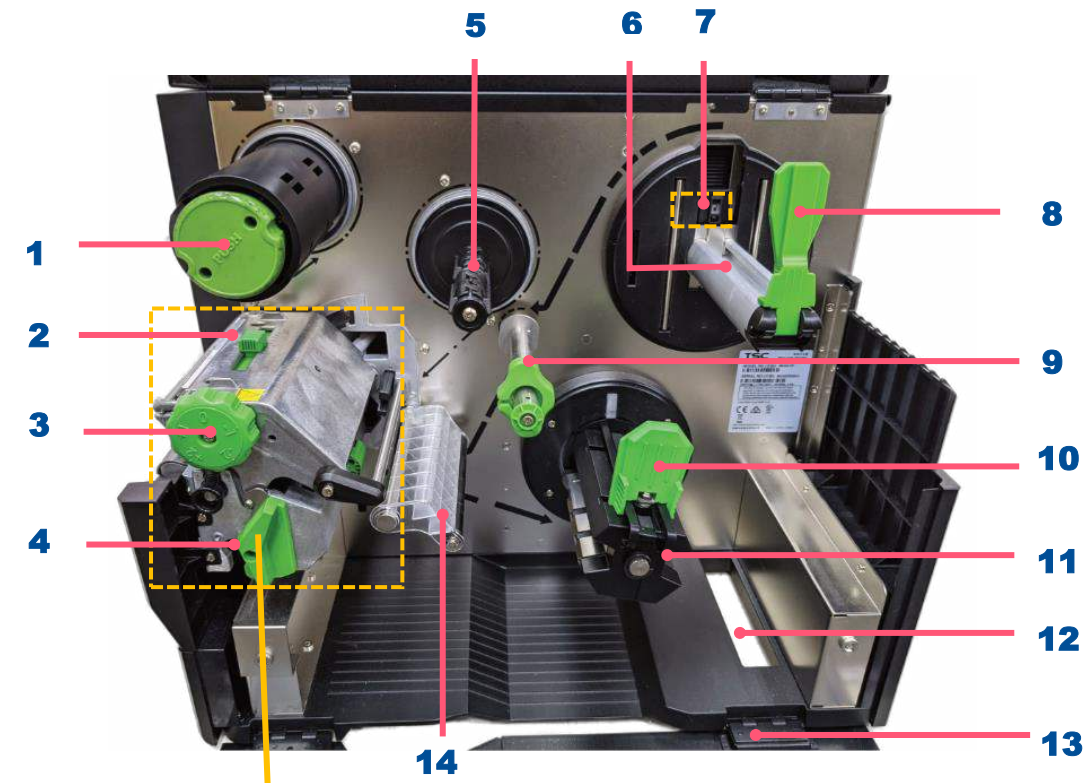

- 1.** Ribbon rewind spindle
- 2.** Print head pressure position adjustment knob
- 3.** Print head pressure adjustment knob
- 4.** Print head release lever
- 5.** Ribbon supply spindle
- 6.** Label supply spindle
- 7.** Media near end sensor (movable, MH241T/MH241P Series only)
- 8.** Label roll guard
- 9.** Media guide bar & rear label guide
- 10.** Media rewind guide
- 11.** Media rewind spindle
- 12.** External label entrance chute
- 13.** Media lower cover
- 14.** Damper

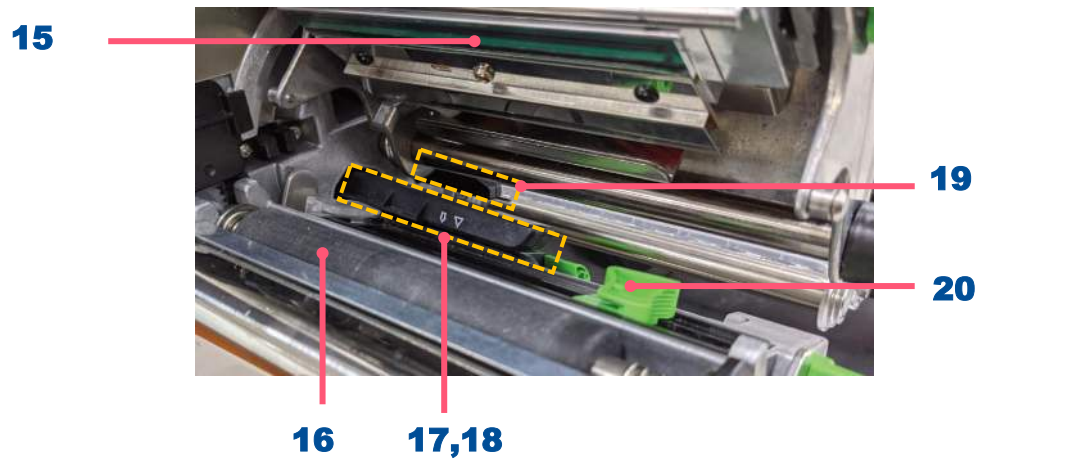

2.2.3 Rear View

MH241/MH241T Series

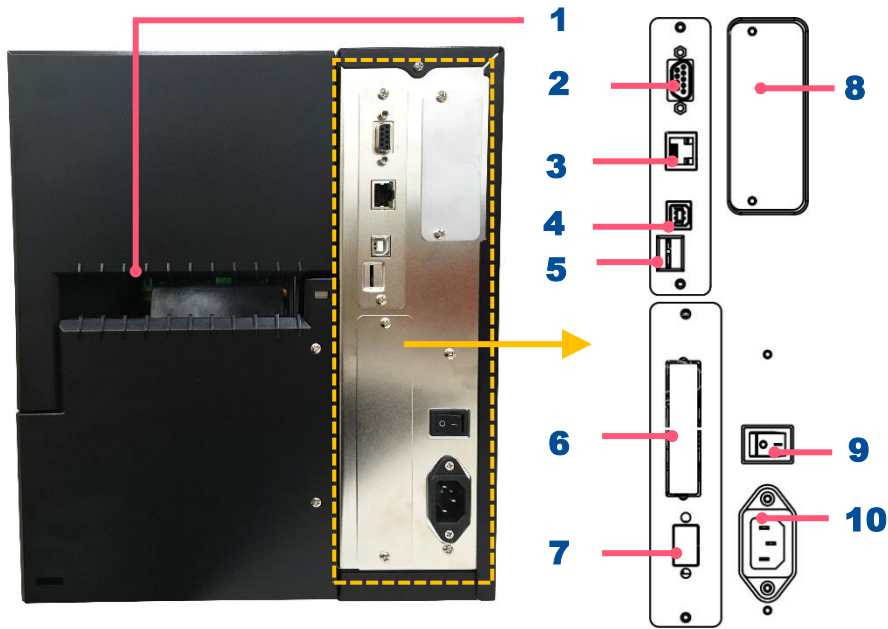

1. External label entrance chute
2. RS-232C interface
3. Ethernet interface
4. USB interface
5. microSD card slot
6. Centronics interface (Option)
7. GPIO interface (Option)
8. Slot-in Wi-Fi interface (Option)
9. Power switch
10. Power cord socket

MH241P Series

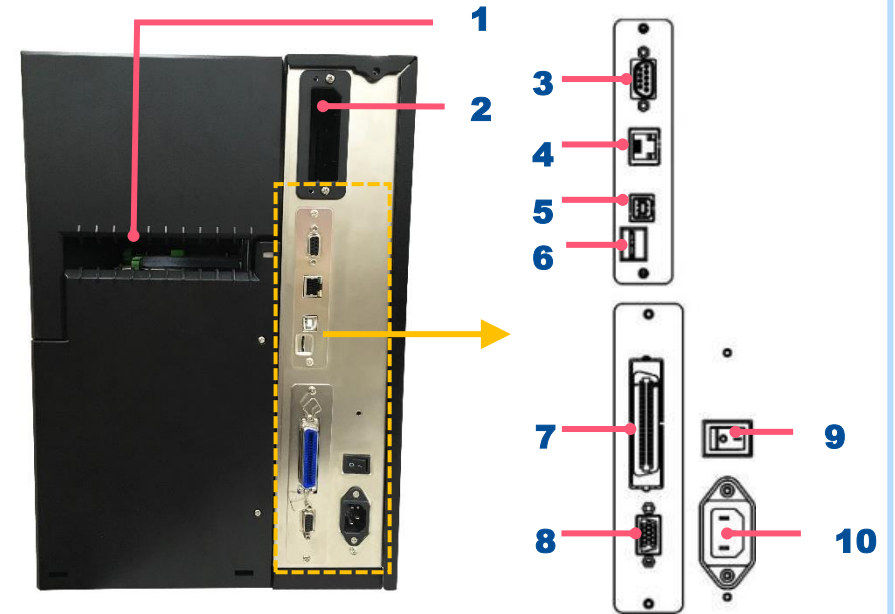

1. External label entrance chute
2. Slot-in Wi-Fi module (Option)
3. RS-232C interface
4. Ethernet interface
5. USB interface
6. microSD card slot
7. Centronics interface (Option)
8. Power switch
9. Power cord socket
10. GPIO interface (Option)

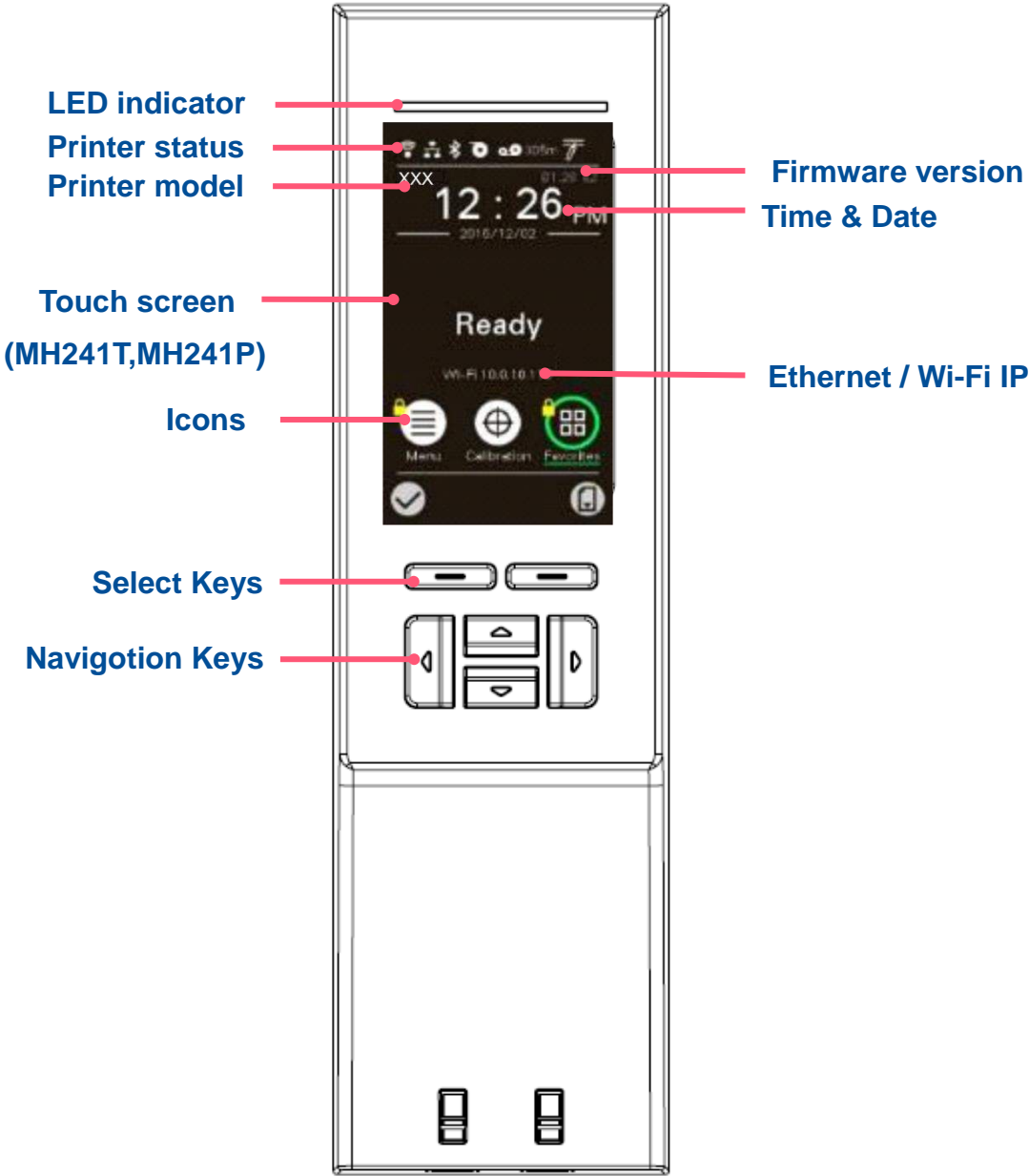

Note: The interface picture here is for reference only. Please refer to the product specification for the interfaces availability.

2.3 Operator Control



2.3.1 LED Indication and Keypads

LED color indication:





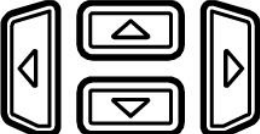





Color	Meaning
 (Green)	Solid: Power is on and ready to be used. Flash : System is downloading data or printer is paused.
 (Amber)	System is clearing data.
 (Red)	Solid - Printer head open, cutter error. Flash - Printing error, such as paper empty, paper jam, ribbon empty, or memory error etc.

Keypads:

Keypads form	Item name	Function
	Select keys	Feed, Pause, Comfirm, Cancel.
	Navigational keys	Select / Navigate.

LCD/LED Icon Indication:

Main Page Icon

Icon	Indication
	Wi-Fi device is ready (option).
	Ethernet is connected.
	Bluetooth device is ready (option).
	Remaining amount of ribbon(m).
	Security lock.
	TPH cleaning.
	Enter the menu.
	Calibrate the media sensor.
	Enter the "Favorites" option.
	Enter cursor (be marked in green) located option.
	Feed button (advance one label).

2.3.2 Touch Screen Manipulation

Tap an item to open/use it.

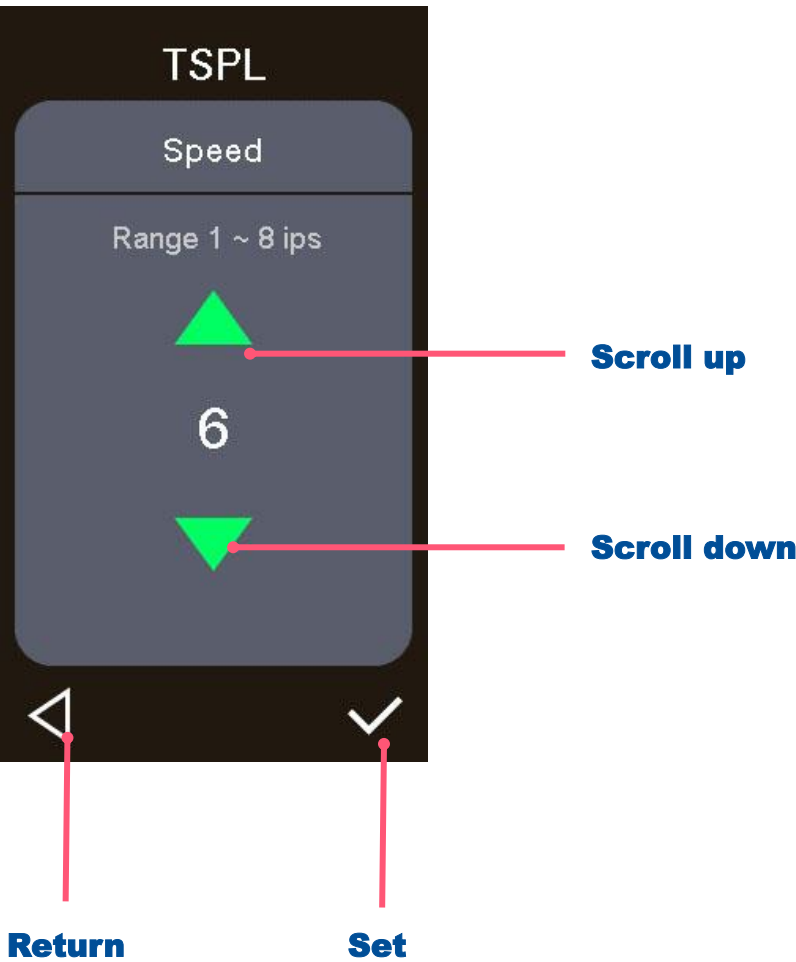
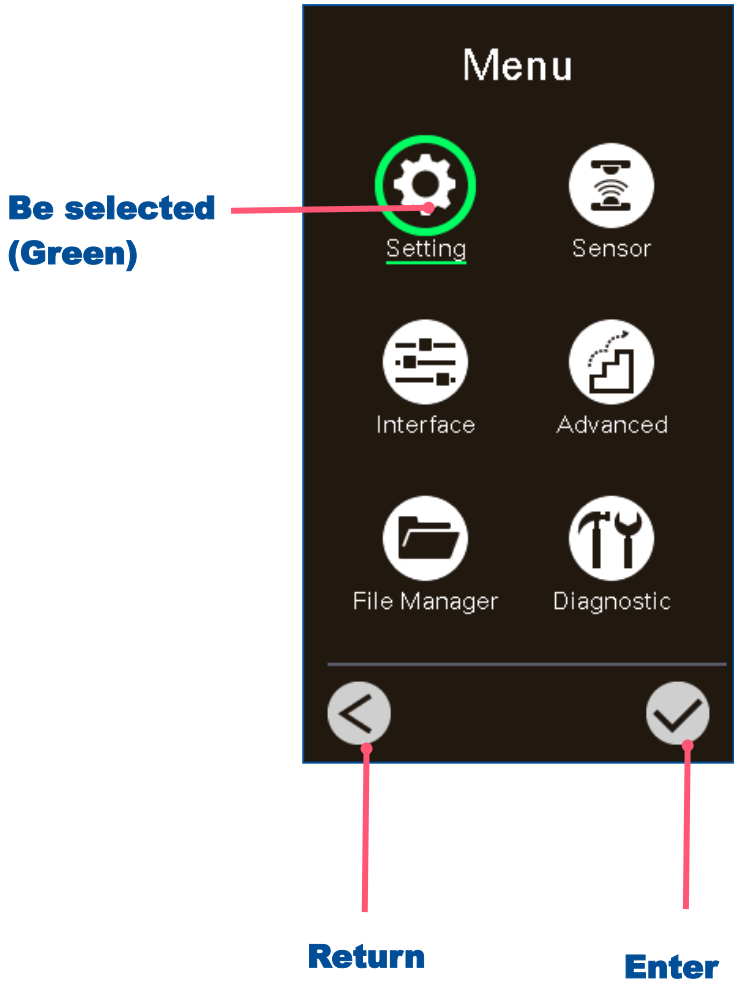

2.3.3 Power-on Utilities

Power-on Utilities provides the basic functions and can be activated by below procedures:

Turn off the power > **Hold** the buttons > **Open** the power > **Release** the button depending on the the color of the LED.

MH Series: power down and hold the right side of the **Select Keys**  to restart the printer.

Sequences of the settings:

LED Colors Functions	Amber	Red (5 blinks)	Amber (5 blinks)	Green (5 blinks)	Green / Amber (5 blinks)	Red / Amber (5 blinks)	Solid green
1. Sensor Calibration (Gap / black mark sensor)		Release					
2. Self-Test (And enter dump mode)			Release				
3. Factory Default				Release			
4. Bline Calibration					Release		
5. Gap Calibration						Release	
6. READY (Skip AUTO.BAS)							Release

3. Setup

3.1 Setting up the printer

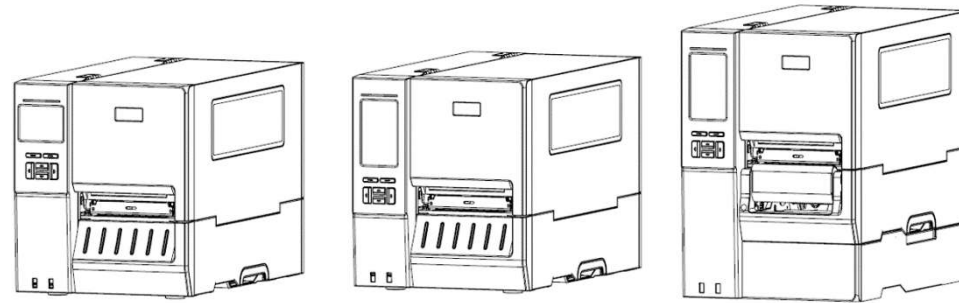

1. Place the printer on flat surface.
 2. Make sure the printer is power off.
 3. Connect the printer to the computer with the provided USB cable.
 4. Plug in the power cord.
- ◆ **Note: Please switch OFF the printer before plugging in the power cord to printer power jack.**

3.2 Loading the Ribbon



1. Open the media cover.



2. Install ribbon on the ribbon supply spindle.



3. Release the lever.

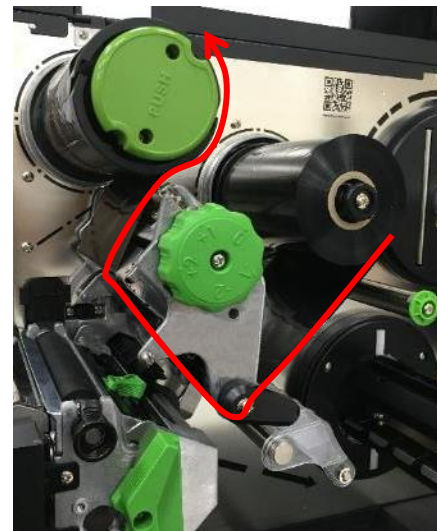

4. Thread ribbon as indicated direction and wind the ribbon rewind spindle until ribbon is properly stretched and wrinkle-free.

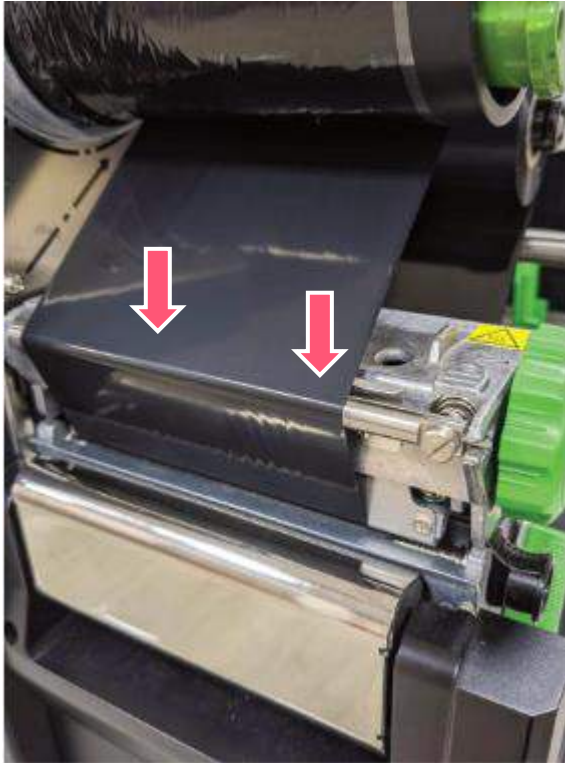

5. Close the print head mechanism and the lever.

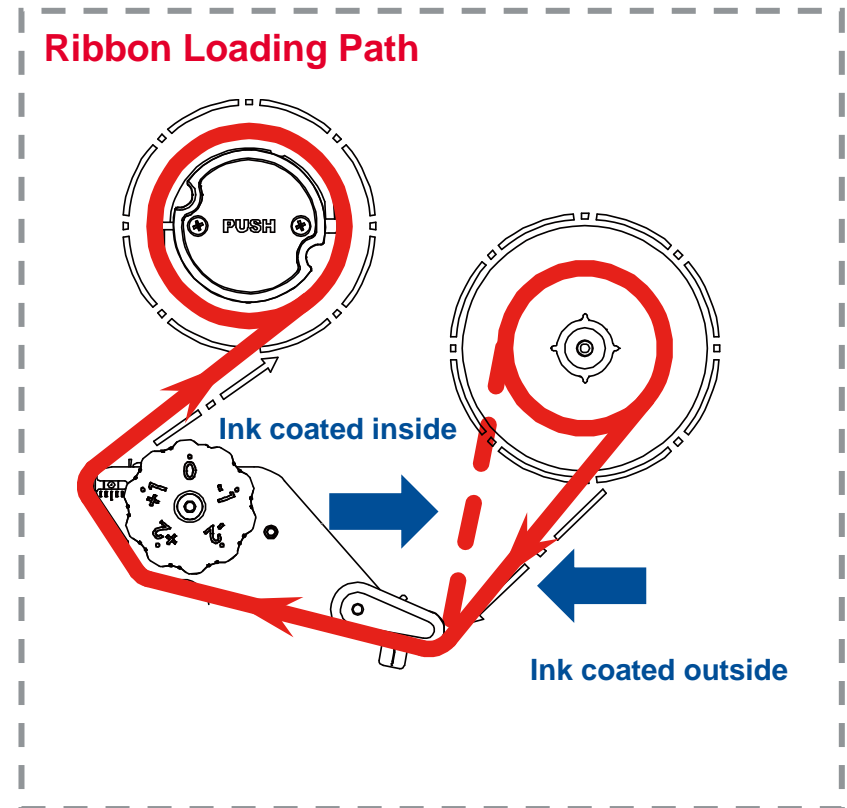

3.3 Loading the Media



1. Open the media cover.



2. Move the label roll guard to the end of the spindle, then turn it down and install the media and use it to make label fixed.

Note:

The media near end sensor is movable, which can detect the capacity of media and remind users to change the media roll.

For 1.5" spindle mode

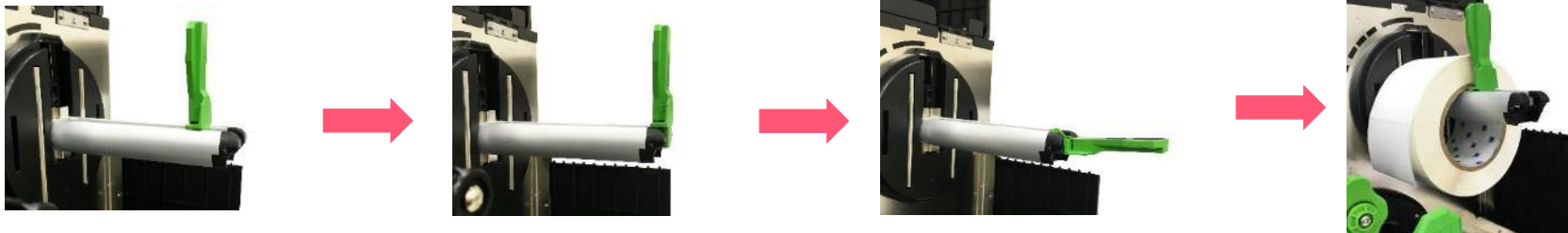

For 1" spindle mode



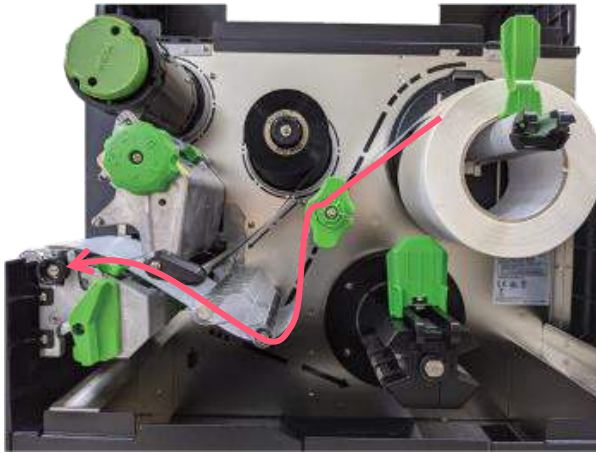

3. Release the lever and thread the label through the media guide bar, damper, media sensor, and label guide to install the media.

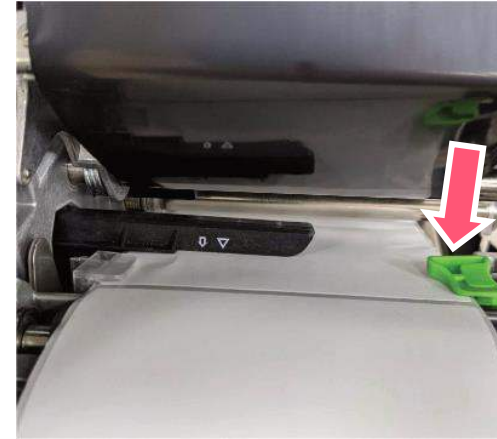

4. Adjust the lable guide to make the media position fixed.

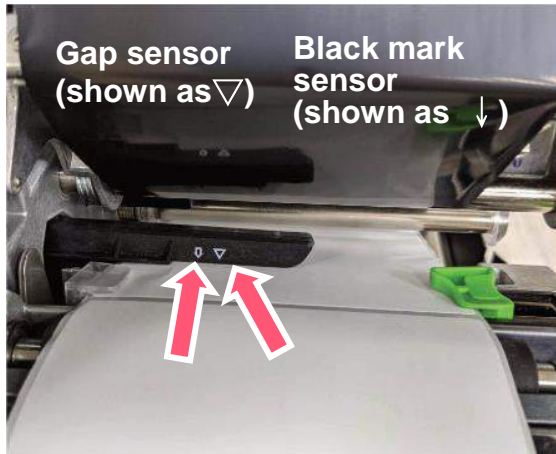

5. Adjust the sensor the sensor to make sure the media can be detected.

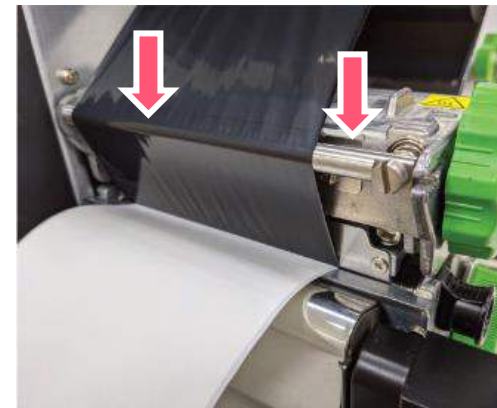

6. Close the print head .

3.4 Loading the Fanfold/External Media



1. Open the printer right side cover.
2. Insert the fanfold media through the rear external label entrance chute.
3. Refer 3.3 to load the media.

Note: Please calibrate the gap/black mark sensor when changing media.

Loading path for fan-fold labels

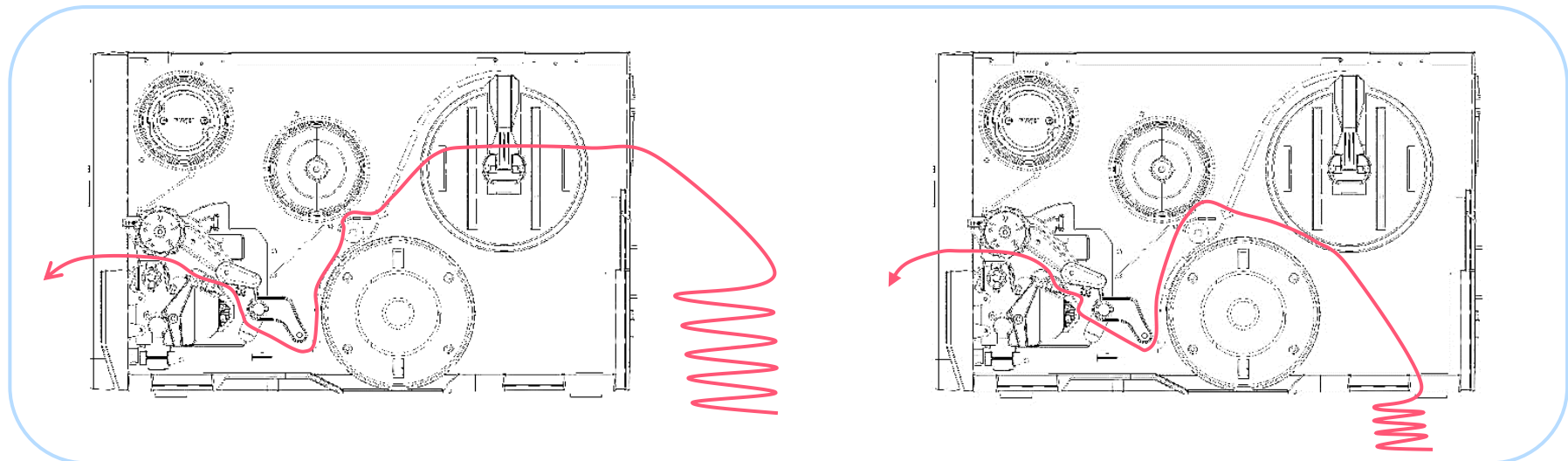

3.5 Loading Media in Peel-off Mode (Option)



1. Open the media cover and load the media.



2. Release lever, pull the label off about 650mm and remove the label. Remove several labels to leave liner.



3. Thread the label as indicated and set printer mode to Peeler Mode.



4. Feed the leading edge of liner through the peel-off module slot as indicated and attach the liner to the liner rewind spindle and turn several circles.



5. Close print head release lever and use the front display panel to set the print mode to "Peel off". Press the FEED button to test.

3.6 Loading Media in Rewinder Mode (Option-MH241P)



1. Open the media cover and load the media.



2. Install the label as indicated and set printer mode to Rewinder Mode.



3. Install the paper core onto the rewind spindle.



4. Feed the leading edge of liner through the peel-off module slot as indicated.



5. Spin the rewind spindle counterwise to make the media be fixed.



6. Adjust the media rewind guide to fit the label width. Close print head and the lower cover.

3.7 Loading Media in Rewinder Mode (Option-MH241/MH241T)



1. Open the media cover and load the media.



2. Install the paper core onto the rewind spindle.



3. Thread the label through the slot on the front cover.

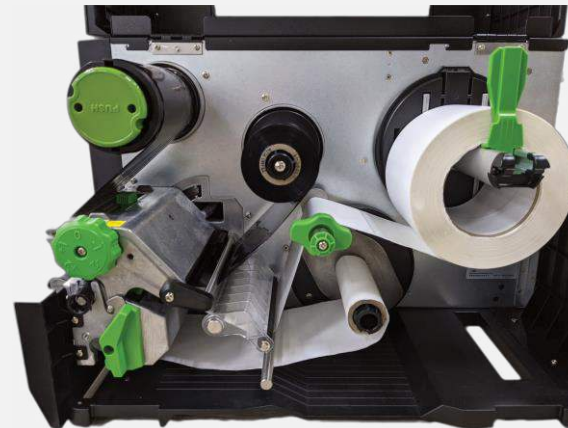

4. Spin the rewind spindle to make the label be fixed. Then close the right cover and print head, and set the print mode to Rewinder Mode.

4. Knob Adjustment

Printhead Pressure Adjustment Knob has 5 levels' adjustment. Different number means different pressure to the springs . Due to media is aligned to the inbound of the printer mechanism, different media width requires the different pressure. Users can try which level can meet their expectation.

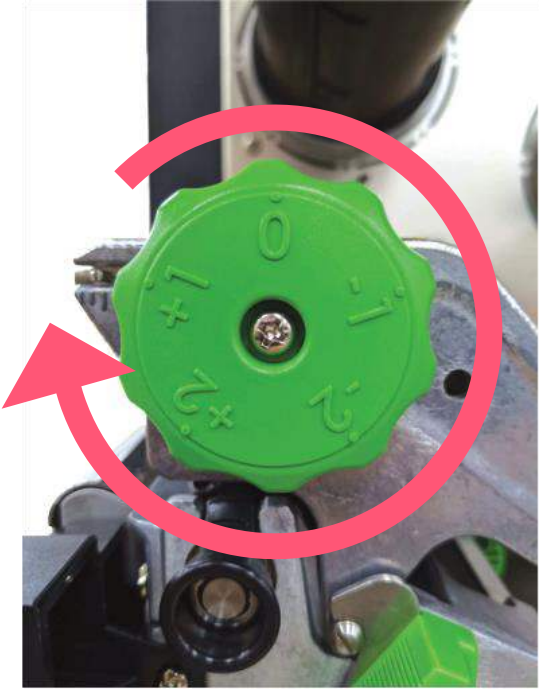
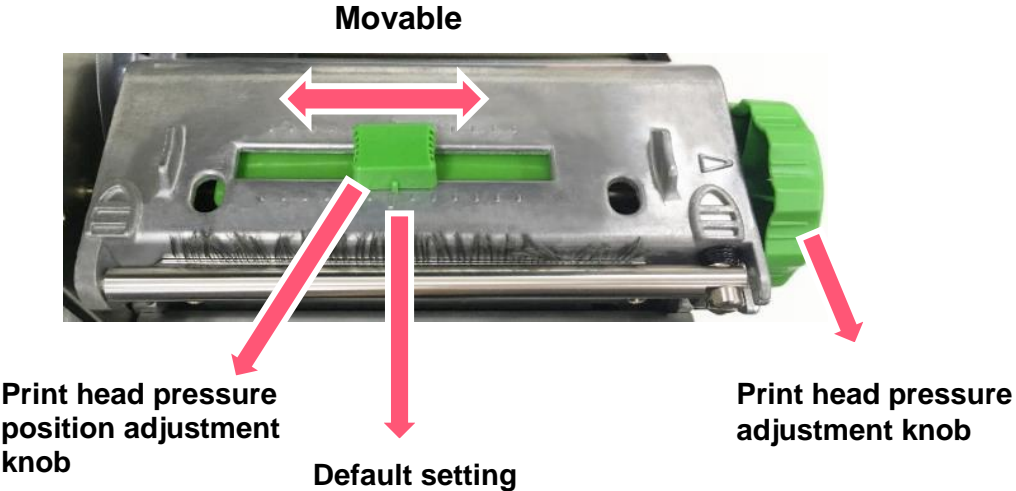

Note:

For the media width less than 2 inches, please fix the **Print head pressure position knob** inside the edge of the label as possible (prevent the unnecessary friction between the print head and platen roller).

4.1 Ribbon Tension Adjustment Knob

Ribbon Tension Adjustment Knob has 5 positions for adjustment. Due to the ribbon is aligned to the inbound of print mechanism, different width of ribbons may need to adjust the tension adjustment knob to avoid the ribbon wrinkle and get the best print quality.

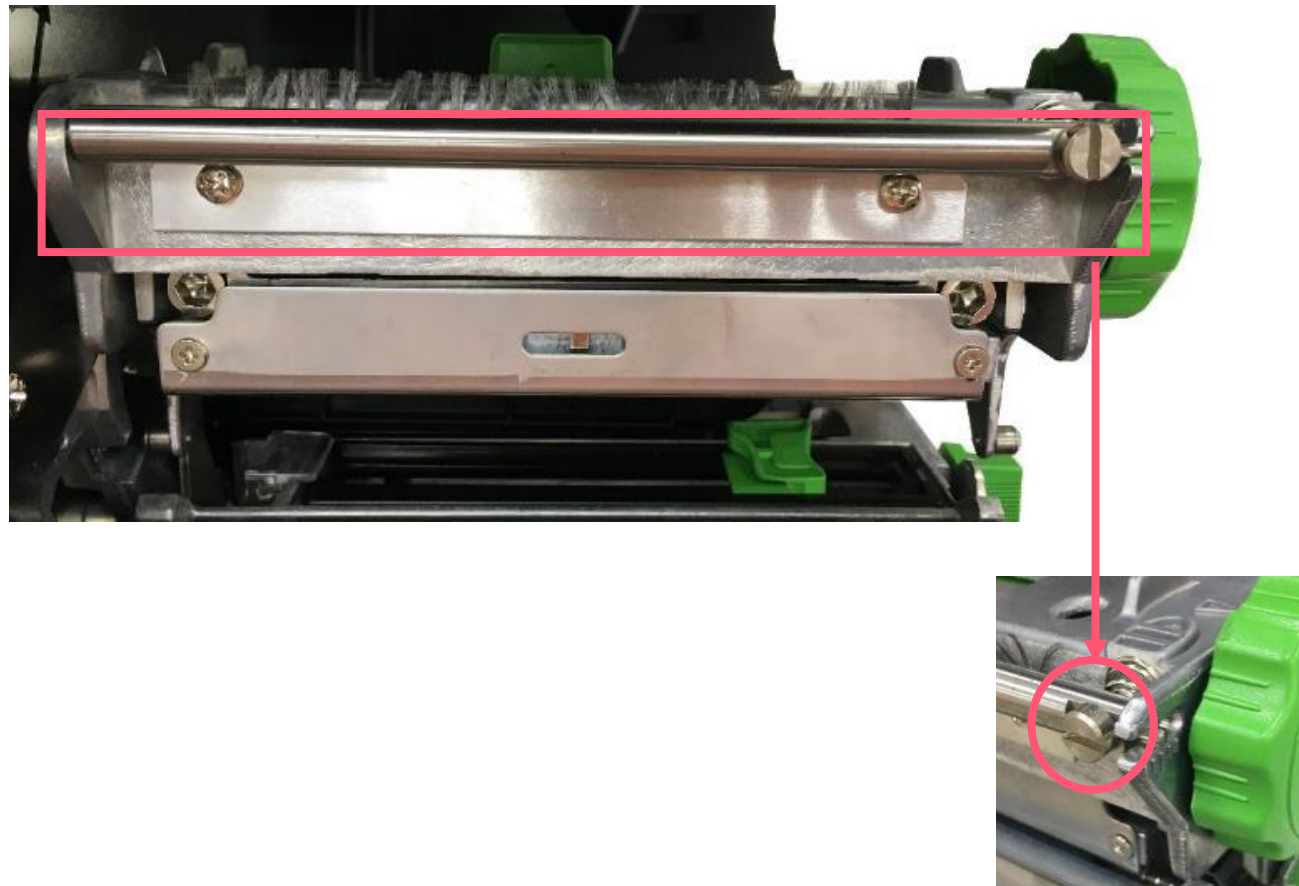

4.2 Mechanism Fine Adjustment to Avoid Ribbon Wrinkles

Ribbon wrinkle is related to the media width, thickness, print head pressure balance, ribbon film characteristics, print darkness setting...etc. In case the ribbon wrinkle happens, please follow the instructions below to adjust the printer parts.

Ribbon Tension Adjustment Knob has 5 positions for adjustment. Use screw driver to change the ribbon tension position.

Wrinkle happens from label lower right to upper left direction

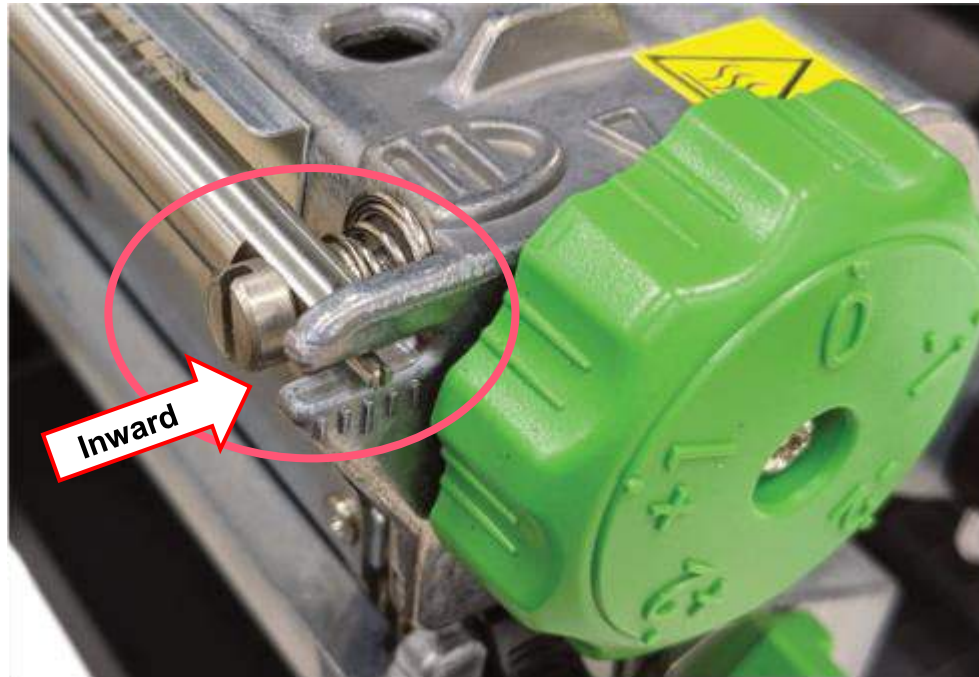

- Make sure the **Print Head Pressure Adjustment Knob** is in correct position for the current media. Ex: 1~2", 3~4"
- Turn the screw clockwise per level and print to see if the wrinkle has gone.
- If the ribbon tension adjustment knob has positioned on the level of innermost side but doesn't improve the ribbon wrinkle, please switch the print head pressure at 1 level and print the label again to check if the wrinkle is gone.
- If the wrinkle can't be avoided, please contact the Customer Service Department of your purchased reseller or distributor for service.

Wrinkle happens from label lower left to upper right direction

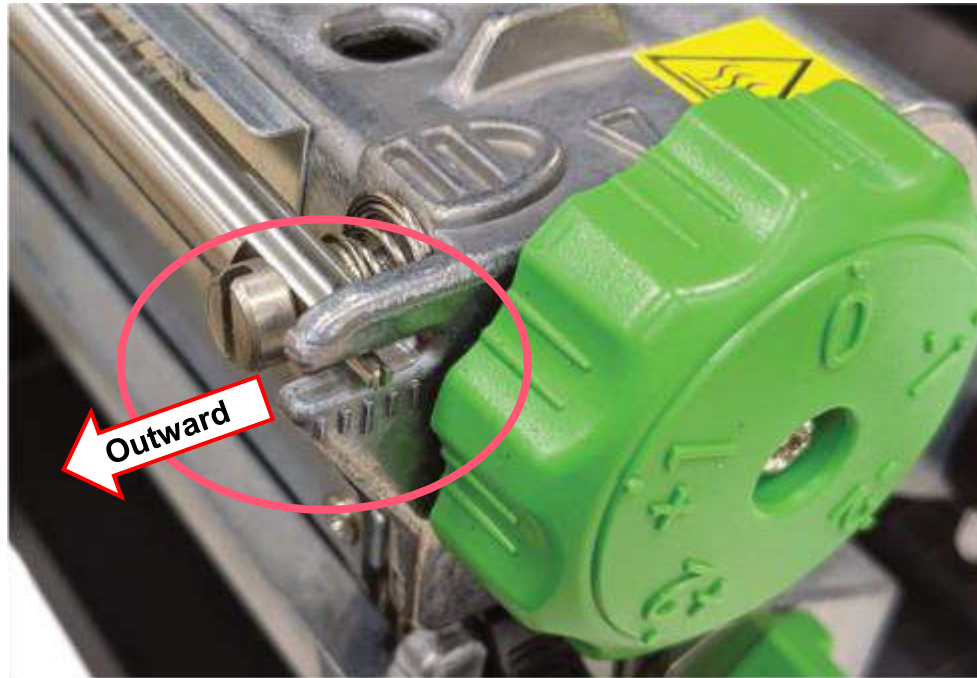
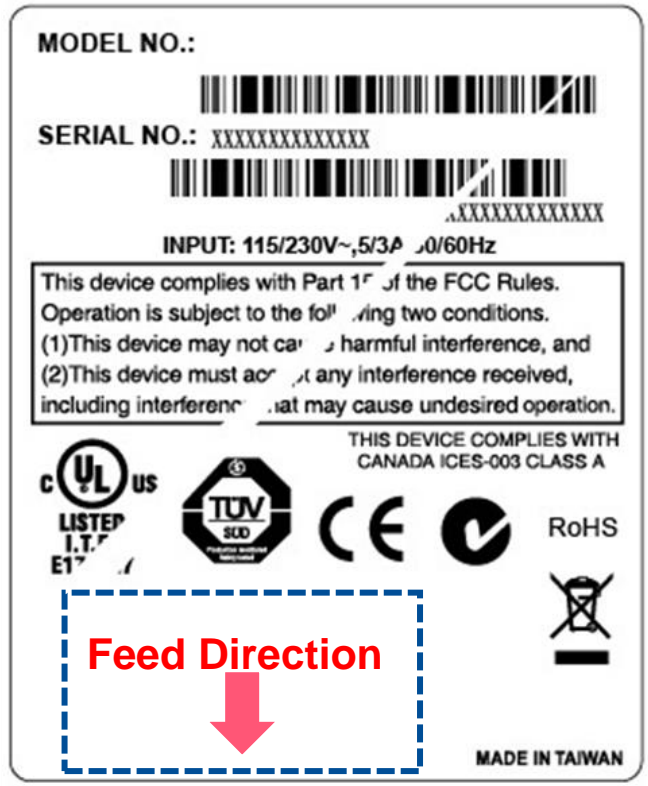

- Make sure the Print head Pressure Adjustment Knob is in correct position for the current media. Ex: 1~2", 3~4"
- Turn the screw counterclockwise per level and print to see if the wrinkle has gone.
- If the ribbon tension adjustment knob has positioned on the level of outermost side but doesn't improve the ribbon wrinkle, please switch the print head pressure at 1 level and print the label again to check if the wrinkle is gone.
- If the wrinkle can't be avoided, please contact the Customer Service Department of your purchased reseller or distributor for service.

5. TSC Console

TSC Console is a management tool combining the Printer Management, Diagnostic Tool, CommTool and Printer Webpage settings, which enables you to adjust printer's settings/status; change printers' settings; download graphics, deploy fonts, graphics, label templates or upgrade the firmware to the group of printers, and send additional commands to printers at the same time.

※ **Printer firmware version before A2.12 will only use 9100 Port as command port; Printer firmware after A2.12 will use 6101 Port as command port.**

5.1 Start TSC Console

- 1. Double click TSC Console icon to start the software.

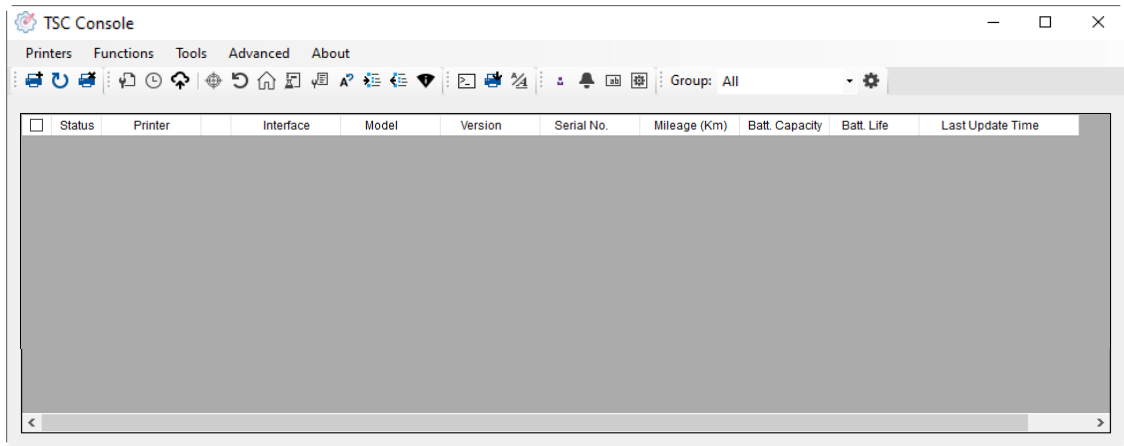

- 2. Manually add the devices by clicking **Printer > Add Printers**.

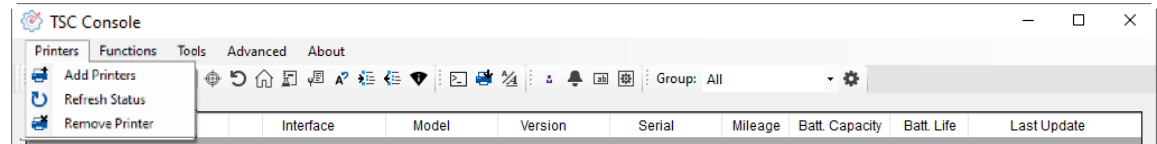

3. Select the current interface of the printer.

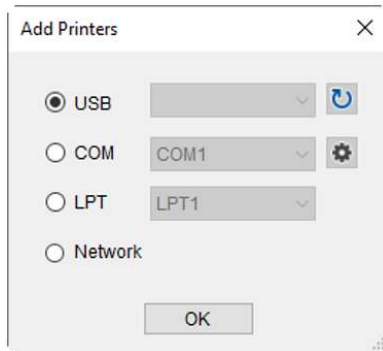

4. The printer will be added to **TSC Console**'s interface.

5. Select the printer and set the settings.

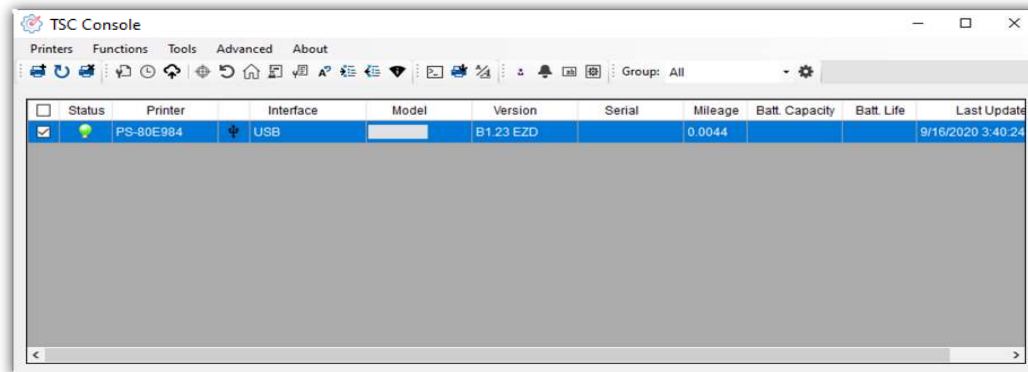

- For more information, please refer to **TSC Console User Manual**.

5.2 Setup Ethernet Interface

- Use **USB** or **COM** to establish the interface on **TSC Console**.

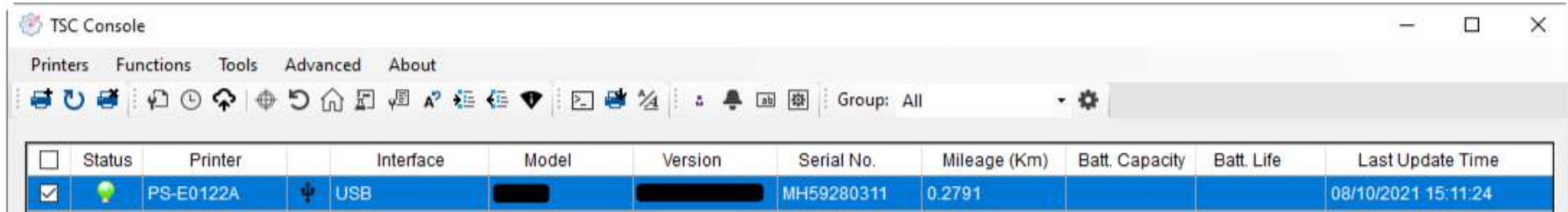

The screenshot shows the TSC Console software interface. At the top, there are menu options: Printers, Functions, Tools, Advanced, and About. Below the menu is a toolbar with various icons. A status bar at the bottom of the toolbar shows 'Group: All'. The main area contains a table with the following columns: Status, Printer, Interface, Model, Version, Serial No., Mileage (Km), Batt. Capacity, Batt. Life, and Last Update Time. The table has one row of data:

Status	Printer	Interface	Model	Version	Serial No.	Mileage (Km)	Batt. Capacity	Batt. Life	Last Update Time
<input checked="" type="checkbox"/>	PS-E0122A	USB			MH59280311	0.2791			08/10/2021 15:11:24

- Double click to enter the **Printer Configuration Page** > Click **Ethernet** tab > Check the **IP Address**.

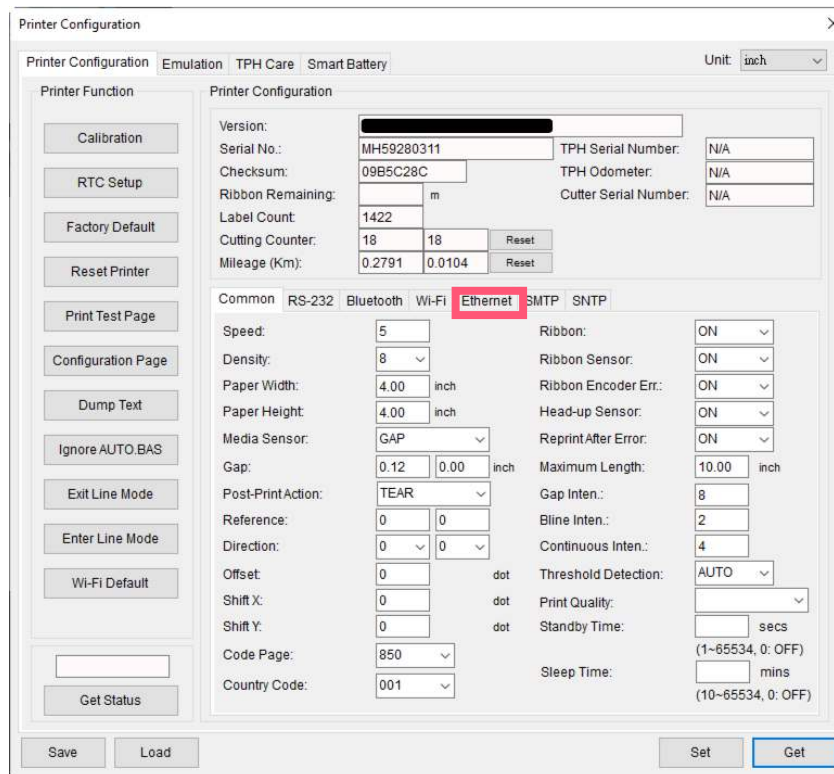

The screenshot shows the 'Printer Configuration' dialog box. The 'Printer Configuration' tab is selected. The 'Ethernet' sub-tab is also selected. The 'DHCP' radio button is selected, and the 'Static IP' radio button is unselected. The IP Address field is highlighted with a red box. The IP Address field contains '10.0.10.181'. The Subnet Mask field contains '255.255.255.0'. The Gateway field contains '10.0.10.251'. The MAC Address field contains '00-1B-82-E0-12-2A'. There are 'Set' buttons next to the IP Address, Subnet Mask, Gateway, and MAC Address fields. There are also 'Set' buttons for the Primary DNS IP, Secondary DNS IP, Printer Name, and Raw Port fields. The Printer Name field contains 'PS-E0122A'. The Raw Port field contains '9100'. There are 'Save', 'Load', 'Set', and 'Get' buttons at the bottom of the dialog box.

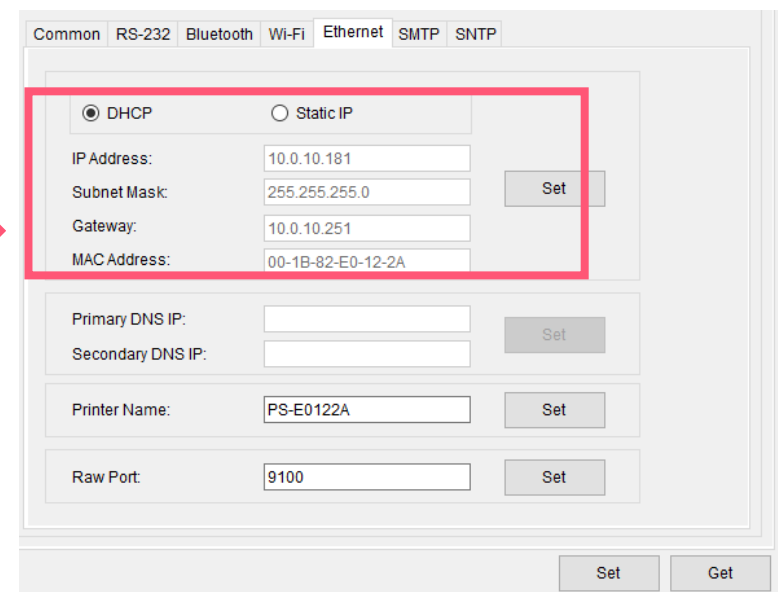

The screenshot shows the 'Ethernet' configuration details. The 'DHCP' radio button is selected, and the 'Static IP' radio button is unselected. The IP Address field contains '10.0.10.181'. The Subnet Mask field contains '255.255.255.0'. The Gateway field contains '10.0.10.251'. The MAC Address field contains '00-1B-82-E0-12-2A'. There are 'Set' buttons next to the IP Address, Subnet Mask, Gateway, and MAC Address fields. There are also 'Set' buttons for the Primary DNS IP, Secondary DNS IP, Printer Name, and Raw Port fields. The Printer Name field contains 'PS-E0122A'. The Raw Port field contains '9100'. There are 'Set' buttons at the bottom of the dialog box.

- Return to **TSC Console** main page > Click **Add Printer** on the top left of the window.

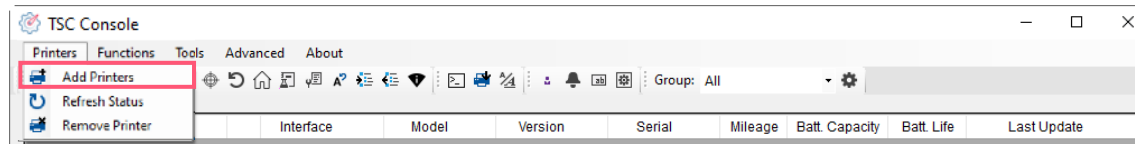

- Choose **Network** > Key in the **IP Address** > Click **Discover** to establish the Ethernet interface.

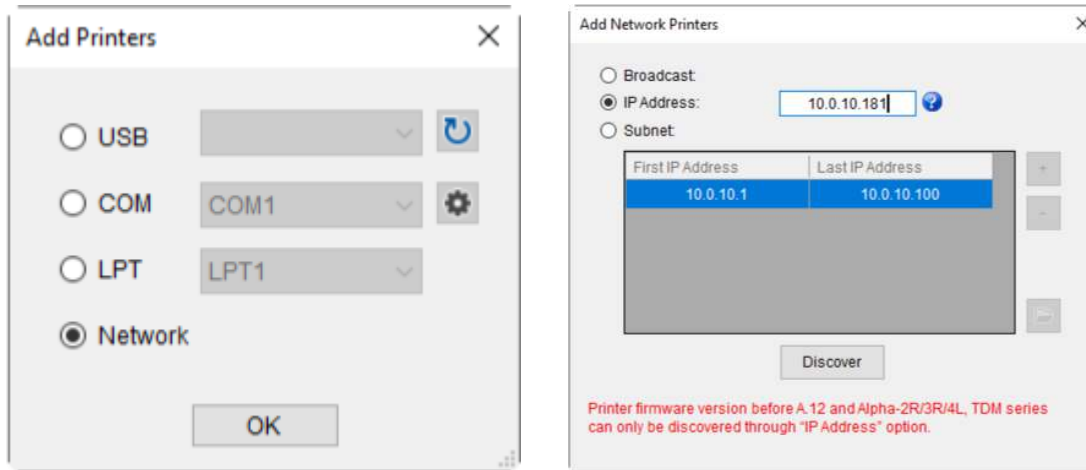

- The notification will pop up > Click **OK** to close the window > The Ethernet interface will be shown on **TSC Console**.

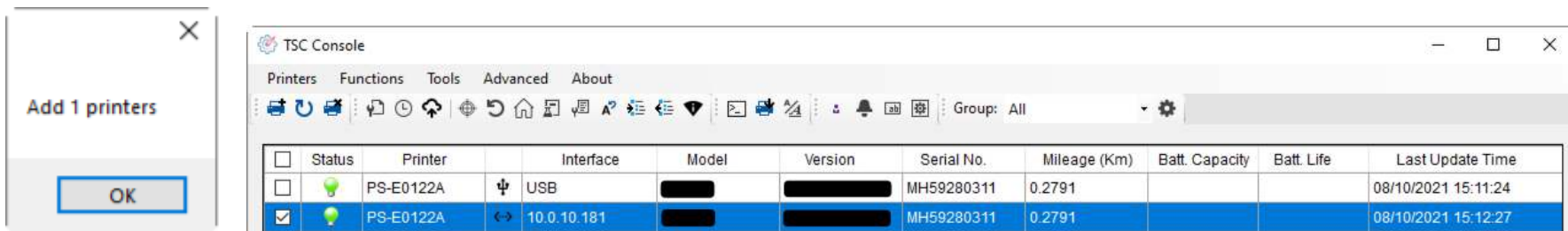

5.3 Set WiFi and Add to TSC Console Interface

- Use **USB** or **COM Port** to set up the interface.
(refer to chp.5.1)
- Double click to enter the printer configuration page.

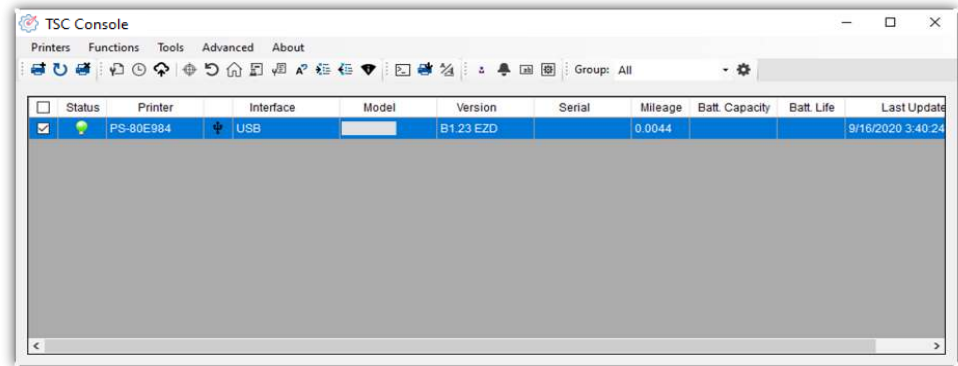

- Click **Get** to receive printer's information.
- Click **Wi-Fi** to the wi-fi setting page.

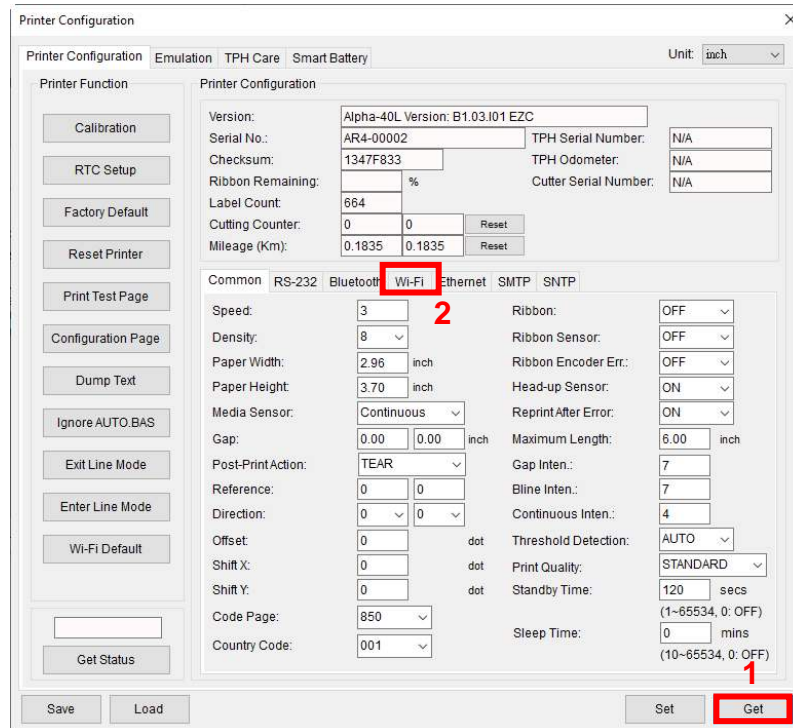

For WPA-Personal

- I. Fill-in the **SSID**.
- II. Select the Encryption option to **WPA-Personal**.
- III. Fill-in the Key.
- IV. Select **DHCP** to **ON**. (For **OFF** option, please fill-in the IP Address, Subnet Mask and Gateway)
- V. After setting, click the **Set** button.

Note:

Before setting, the entered field will be shown in yellow for reminding.

On DHCP, user can change the printer name by another model name in "Printer Name" field.

User also can change the raw port in "Raw Port" field.

Common RS-232 Bluetooth Wi-Fi Ethernet SMTP SNTP

Built-in Wi-Fi Module

SSID: SSID_1

WLAN Encryption: WPA-Personal

Key: ●●●●

DHCP: ON

IP Address: 0.0.0.0

Subnet Mask: 0.0.0.0

Gateway:

Primary DNS IP:

Secondary DNS IP:

Raw Port: 9100

Printer Name: PS-FF153C

MAC Address: 00:1B:82:FF:15:3C

EAP Type:

Username:

Password:

CA Certificate:

Client Certificate:

Private Key:

EAP-FAST PAC:

File Name Browse

Wi-Fi Version: 3.7.1.0R6

RSSI: 0

Set Get

For WPA-Enterprise

- I. Fill-in the **SSID**.
- II. Select the Encryption option to **WPA2-Enterprise**.
- III. Select DHCP to **ON** (For **OFF** option, please fill-in the IP Address, Subnet Mask and Gateway)
- IV. Select the **EAP Type** option. (For **EAP-TLS** option, please upload the CA and Key for mutual authentication, integrity-protected cipher suite negotiation, and key exchange between two endpoints.)
- V. After setting, click the **Set** button.

Note:

Before setting, the entered field will be shown in yellow for reminding.

On DHCP, user can change the printer name by another model name in "Printer Name" field.

User also can change the raw port in "Raw Port" field.

Common RS-232 Bluetooth Wi-Fi Ethernet SMTP SNTP

Built-in Wi-Fi Module

SSID: SSID_2

WLAN Encryption: WPA-Enterprise

Key: ●●●●

DHCP: ON

IP Address:

Subnet Mask: 0.0.0.0

Gateway:

Primary DNS IP:

Secondary DNS IP:

Raw Port: 9100

Printer Name: PS-FF153C

MAC Address: 00:1B:82:FF:15:3C

EAP Type:

Username:

Password:

CA Certificate:

Client Certificate:

Private Key:

EAP-FAST PAC:

File Name Browse

Wi-Fi Version: 3.7.1.0R6

RSSI: 0

Set Get

- After clicking **Set** button, it'll pop-up the window tip as below shown.

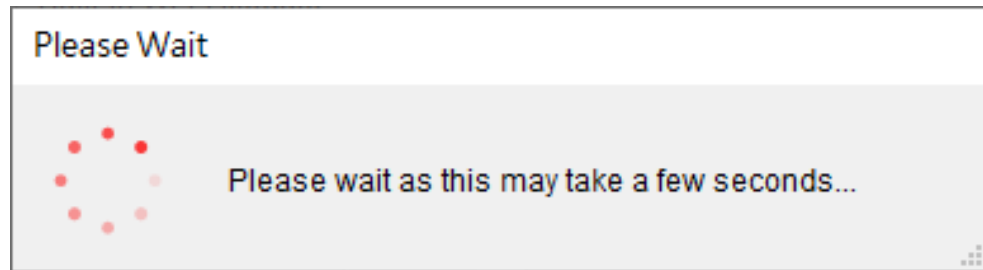

- IP address will be shown in the "IP address" field and the Wi-Fi logo and IP address will be displayed on the LCD control panel.

Note:

IP address should be shown within about 5~15 seconds after printer turn on. If not, please refer to steps below to initialize the printer Wi-Fi module settings then to setup it again.

- Remove the cable between the computer and the printer.
- Go to main page, click **Add Printer** to add the printer via **Network**.
- Select the printer and enter the setting page by double clicking the printer.
- Click the **Print Test Page** button to print the test page via Wi-Fi interface.

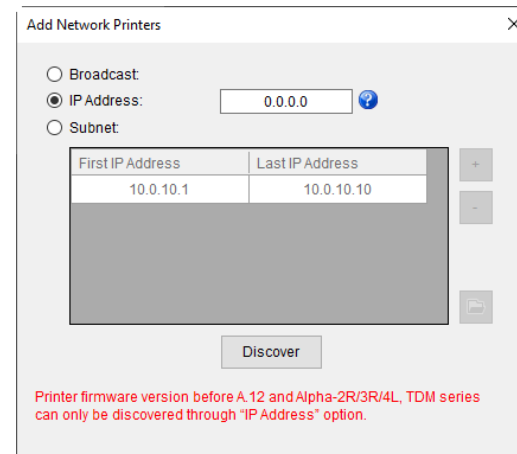

5.4 Initialize the Printer WiFi Setting

1. Return to the main page of TSC Console.

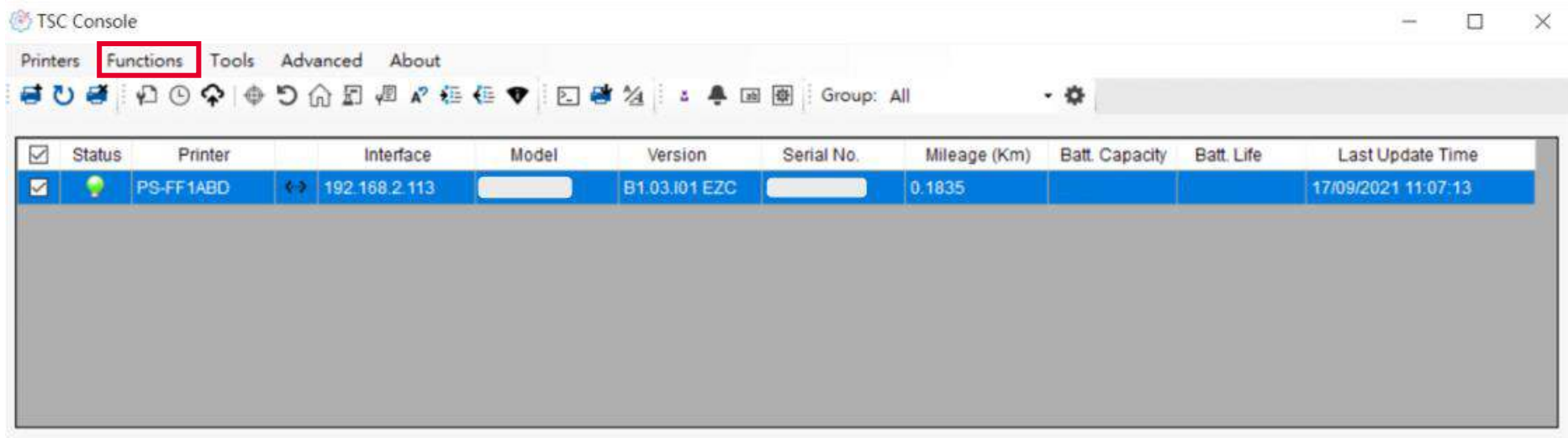

2. Click **Functions** to expand the page.
3. Click **Wi-Fi Default** to initialize the printer Wi-Fi module setting to factory default setting.

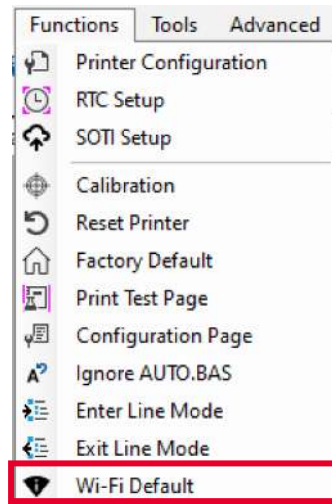

5.5 TPH Care

TPH Care provides users to check the condition of the print head and be able to set the dot failure threshold for indicating errors when the threshold is triggered.

This option is used to enable (ON)/ disable (OFF) the TPH care function.

This option is used to check the numbers of unhealthy TPH dot element.

This option is used to detect the unhealthy TPH dot.

This option is used to set the threshold for unhealthy TPH dot number.

This image is used to check the relative position of the unhealthy TPH dot.

This option is used to print a TPH test image to check the TPH printing result.

1. Enable the TPH Care function. (Note: The default is disabled/OFF.) Then click "Get TPH care profile" button and a diagram will show in the area above.
2. If the profile is flat, it means that the print head is good. Check "Unhealthy TPH dot number". If the result is zero (0), that means the print head is good.
3. Bad dots are presented as a spike in the profile. The arrow in below iprofile indicates the presence of potentially damaged dots and printer will stop printing.

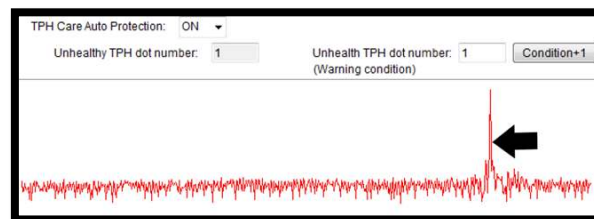

5.6 Printer Function

Printer Function could be found in Printer Configuration. “Printer Function” will be shown on the left side of the window.

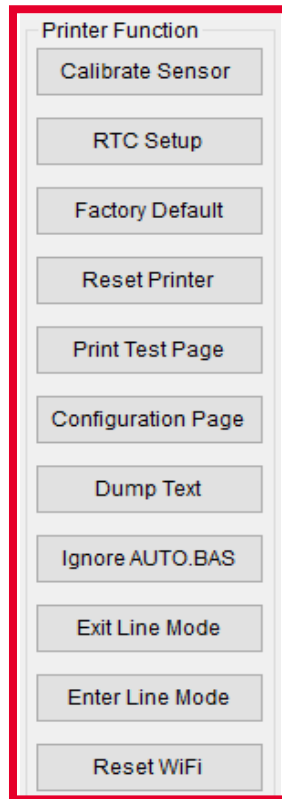

Functions	Description
Calibrate Sensor	Detect media types and the size of the label
RTC Setup	Synchronize printer with Real Time Clock on PC
Factory Default	Initialize the printer to default settings
Reset Printer	Reboot printer
Print Test Page	Print test page according to the specified label size and sensor type.
Configuration Page	Print printer configurations
Dump Text	Activate the printer to dump mode
Ignore AUTO.BAS	Ignore AUTO.BAS file when printer boot up.
Exit Line Mode	Exit the line mode to page mode
Enter Line Mode	Leave page mode and enter line mode
Reset WiFi	Restore the WiFi settings to defaults.

5.7 Setting Post-Print Action

When the printer is equipped with other option kits, ex: cutter, peeler, rewinder, please select the mode after finishing the calibration.

Follow below procedure to set the post action for the printing:

Refer Chp 5.1 to Connect the printer with **TSC Console** > **Double click** the printer > The **Printer Configuration Page** will pop up > Click **Get** to load information > Go to **Common Tab** > Find **Post-Print Action** > **Select the mode** depends on users' application > Click **Set**.

The screenshot shows the 'Printer Configuration' window with the 'Common' tab selected. The 'Post-Print Action' dropdown menu is open, showing options: OFF, TEAR, PEEL, CUTTER, REWIND, and APPLICATOR. A red box highlights the dropdown, and a blue circle '2' is next to it. At the bottom, the 'Set' and 'Get' buttons are highlighted with red boxes, with blue circles '3' and '1' next to them respectively. The 'Save' and 'Load' buttons are also visible at the bottom left.

Printer Function	Printer Configuration
Calibration	Version: []
RTC Setup	Serial No.: [] TPH Serial Number: N/A
Factory Default	Checksum: 1344B9B1 TPH Odometer: N/A
Reset Printer	Ribbon Remaining: [] % Cutter Serial Number: N/A
Print Test Page	Label Count: 553
Configuration Page	Cutting Counter: 0 0 [Reset]
Dump Text	Mileage (Km): 0.0913 0.0913 [Reset]
Ignore AUTO.BAS	Common RS-232 Bluetooth Wi-Fi Ethernet SMTP SNTP
Exit Line Mode	Speed: 3 Ribbon: OFF [v]
Enter Line Mode	Density: 8 [v] Ribbon Sensor: OFF [v]
Wi-Fi Default	Paper Width: 104.00 mm Ribbon Encoder Err.: OFF [v]
Get Status	Paper Height: 74.05 mm Head-up Sensor: ON [v]
Save	Media Sensor: Black Mark [v] Reprint After Error: ON [v]
Load	Gap: 1.99 0.00 mm Maximum Length: 152.25 mm
	Post-Print Action: [v] Gap Inten.: 7 [v]
	Reference: OFF Bline Inten.: 7 [v]
	Direction: TEAR Continuous Inten.: 4 [v]
	Offset: PEEL Threshold Detection: AUTO [v]
	Shift X: CUTTER [dot] Print Quality: STANDARD [v]
	Shift Y: REWIND [dot] Standby Time: 120 secs
	Code Page: 850 [v] Sleep Time: 0 mins
	Country Code: 001 [v] (1~65534, 0: OFF)
	(10~65534, 0: OFF)



6. LCD Menu Function

6.1 Enter the Menu

- **By touch display:**

Tap the  (Menu) icon on LCD main page to enter the menu.

- **By Keys:**

Use navigational keys to select the  (Menu) icon (be marked in green) and press the left soft key button (means ) to enter the menu.

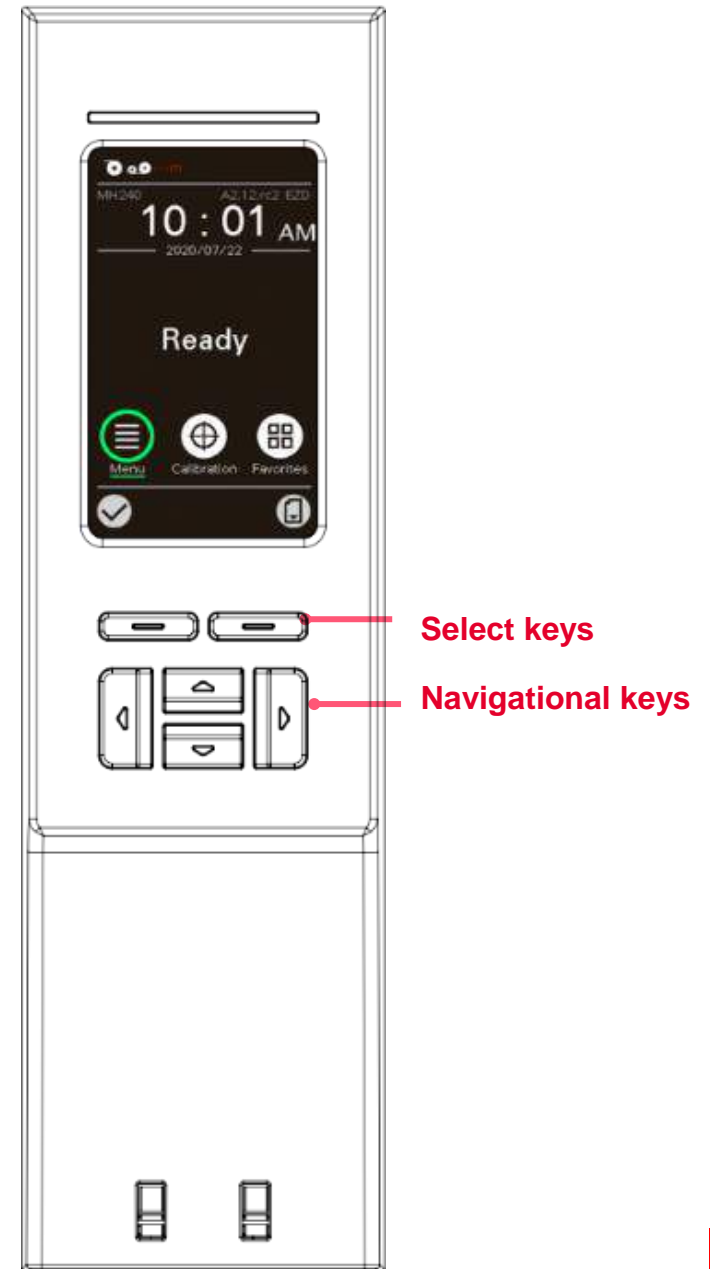

6.2 Menu Overview

There are 6 categories on the menu. Users can easily set the settings of the printer without connecting the computer. Please refer to following sections for more details.



Setting : To set up the printer settings for TSPL & ZPL2.



Advanced : To set LCD, initialization, cutter type,...etc.



Sensor : To calibrate the selected media sensor.



File Manager : To check and manage printer's memory storage.

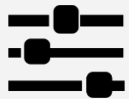

Interface : To set the printer interface settings.



Diagnostic : To check printer and help users to troubleshoot the problems.

6.3 Setting

Tap the **Command Set** on LCD to switch between TSPL and ZPL2. **Command Set** can also be activated by **Navigational Keys**.

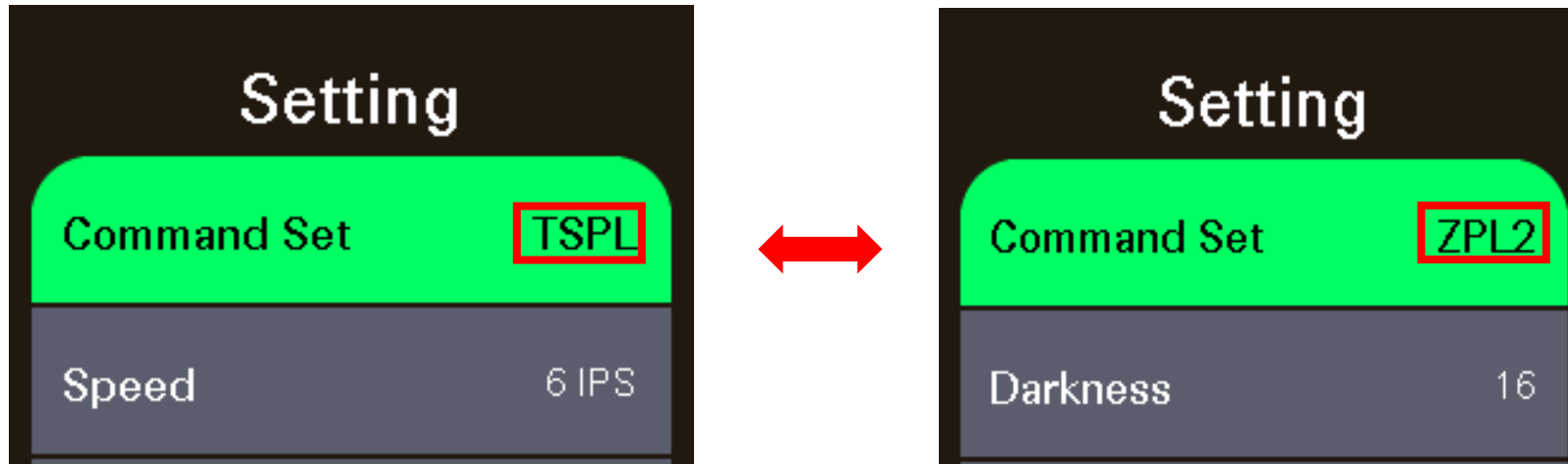

6.3.1 TSPL

TSPL category can set up the printer settings for TSPL.

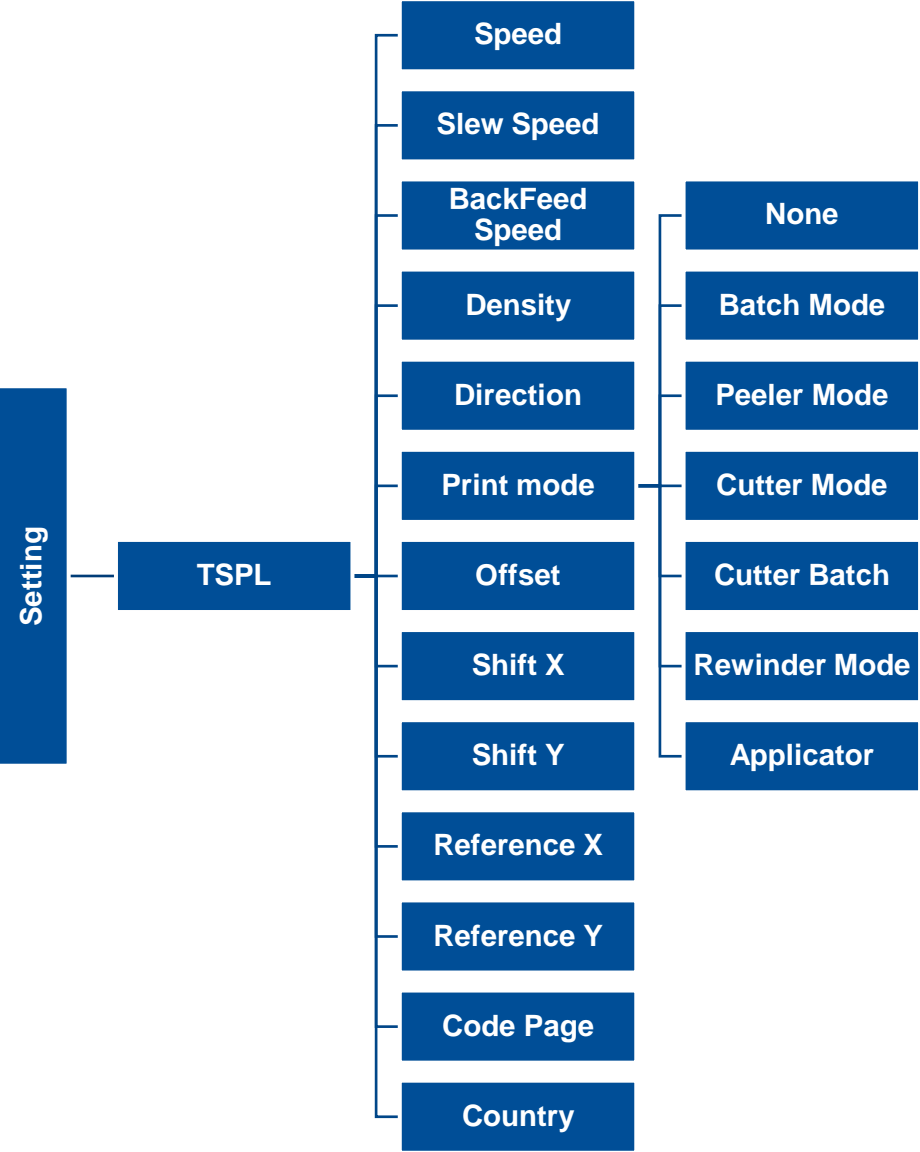

Item	Description	Default
Speed	Set the print speed. Setting range: 2~14 for 203dpi; 2~12 for 300dpi; 1~6 for 600dpi	203 dpi: 6 300 dpi: 4 600 dpi: 3
Slew Speed	Set feed speed	203 dpi: 6 300 dpi: 4 600 dpi: 3
Back Speed	Set back speed	2
Density	Set printing darkness. Setting range: 0 to 15, and the step is 1.	8
Direction	Set the printout direction. Setting Value: 0 and 1. Direction 0: <input type="text" value="Direction"/> Direction 1: <input type="text" value="Direction"/>	0
Print mode	Set the print mode. There are 6 modes in total: None: Next label top of form is aligned to the print head burn line location. (Tear Off Mode) Batch Mode: Once finishing the printing process, label will be fed to the tear plate location. Peeler Mode: Enable the label peel off mode. Cutter Mode: Enable the label cutter mode. Cutter Batch: Cut the label once at the end of the printing job. Rewinder Mode: Enable the label rewinder mode. Applicator: The printer prints a label when it receives a signal from the applicator.	Batch Mode
Offset	Adjust media stop location. Available value setting range: -999 dots to 999 dots.	0 dot
Shift X	Adjust print position. Available value setting range: -999 dots to 999 dots.	0 dot
Shift Y		0 dot
Reference X	Set the origin of printer coordinate system horizontally and vertically. Available setting range: 0 dot to 999 dots.	0 dot
Reference Y		0 dot
Code page	Set the code page of international character set.	950
Country	Set the country code. Available setting value range: 1 to 358.	001

Note: If printing from enclosed software/driver, the software/driver will send out the commands, which will overwrite the settings set from the panel.

6.3.2 ZPL2

This "ZPL2" category can set up the printer settings for ZPL2.

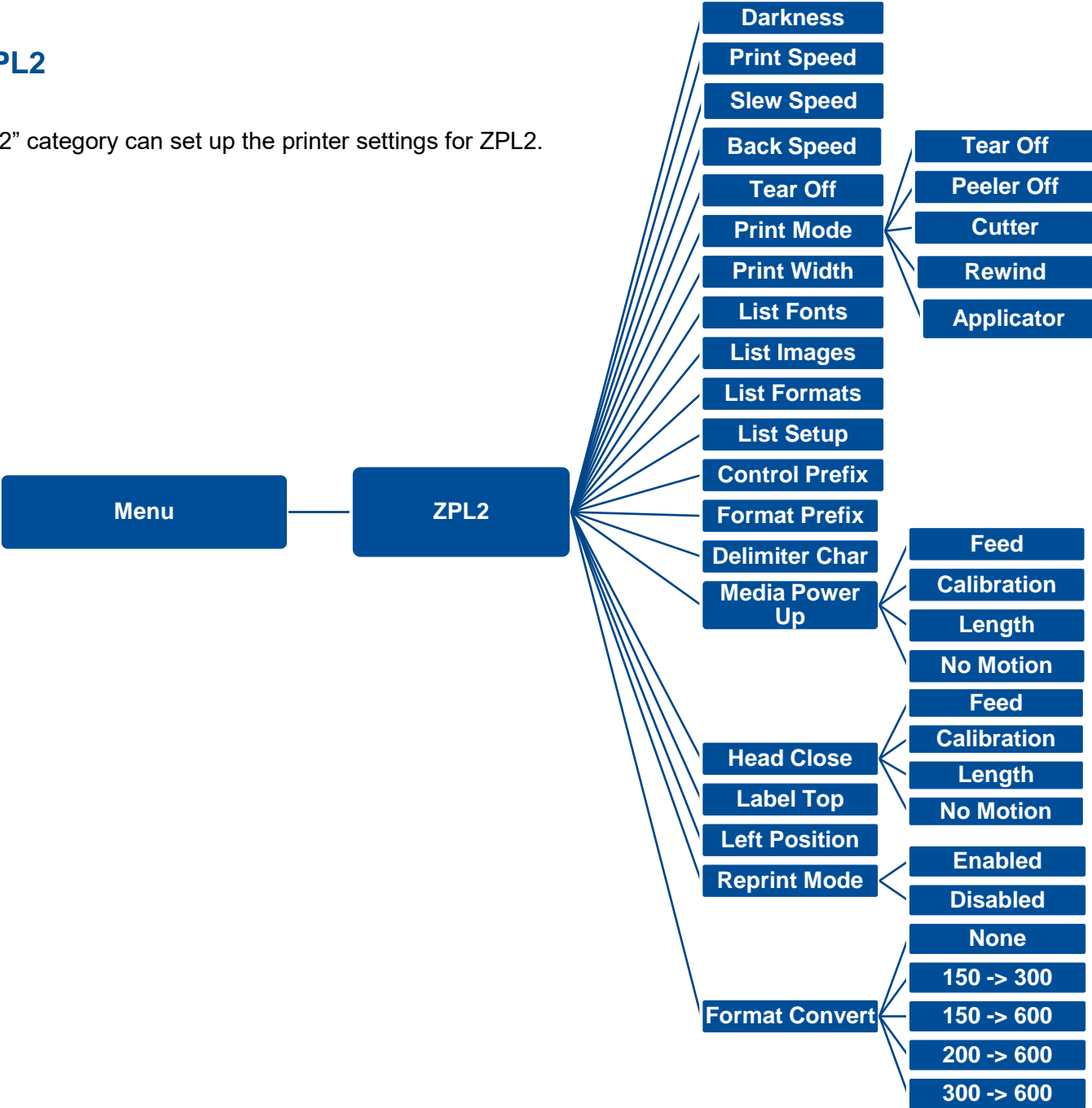

Item	Description	Default
Density	Set the printing darkness. Available setting range: 0 to 30.	16
Print Speed	Set the print speed. Available setting range is 2~18 for 203dpi and 2~14 for 300dpi; 1.5~6 for 300dpi..	203 dpi: 6 300 dpi: 4 600 dpi: 3
Slew Speed	Set feed speed	203 dpi: 6 300 dpi: 4 600 dpi: 3
Back Speed	Set back speed	2
Tear Off	Adjust media stop location. Available setting value range: -120~120 dots. Set the print mode. There are 4 modes:	0 dot
Print mode	<p>Tear Off: Next label top of form is aligned to the print head heating line location.</p> <p>Peeler Off: Enable the label peel off mode.</p> <p>Cutter: Enable the label cutter mode</p> <p>Rewind: Enable the label rewind mode</p> <p>Applicator: The printer prints a label when it receives a signal from the applicator.</p>	Tear Off
Print Width	Set the print width. Available setting range: 2 ~ 999 dots.	812
List Fonts	Print the current fonts list from the memory devices to the label.	N/A
List Images	Print current printer available images list stored at the memory device to the label.	N/A
List Formats	Print current printer available formats list from the memory devices to the label.	N/A
List Setup	Print current printer configuration to the label.	N/A
Control Prefix	Set control prefix character.	N/A
Format Prefix	Set format prefix character.	N/A

Delimiter Char	Set delimiter character.	N/A
	Set the action of the media when turning on the printer.	
	Feed: Printer will advance one label.	
Media Power Up	Calibration: Printer will make calibration.	No Motion
	Length: Printer determine length and feed label.	
	No Motion: Printer will not move media.	
	Set the action of the media when closing the print head.	
	Feed: Printer will advance one label.	
Head Close	Calibration: Printer will make calibration.	No Motion
	Length: Printer determine length and feed label.	
	No Motion: Printer will not move media.	
Label Top	Adjust print position vertically on the label. Value range: -120 to +120 dots.	0
Left Position	Adjust print position horizontally on the label. Value range:-9999 to +9999 dots.	0
Reprint Mode	Reprint the last label by pressing  button on printer's control panel.	Disabled
Format Convert	Select the bitmap scaling factor. The first number is the original dots per inch (dpi) value; the second the dpi which you would like to scale.	None

Note: printing from other software/drive will overwrite the settings set from the panel.

6.4 Sensor

This option is used to calibrate the selected sensor. We recommend calibrate the sensor before printing when changing the media.

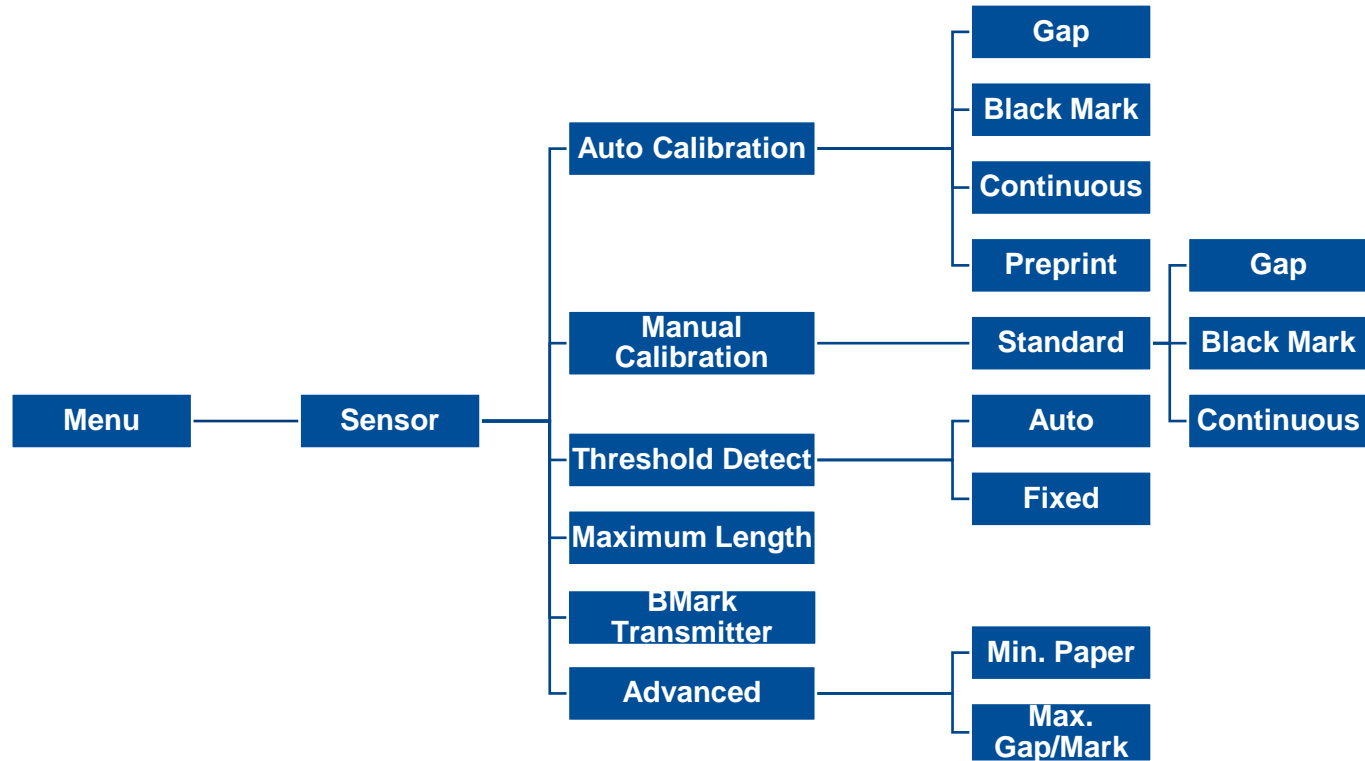

Item	Description	Default
Auto Calibration	Set the media sensor type and calibrate the selected sensor automatically.	N/A
Manual Calibration	In case Auto Calibration does not work, please use “Manual” function to set the paper length and gap/bline size to complete the calibration setting.	N/A
Threshold Detect	Set sensor sensitivity in fixed or auto.	Auto
Maximum Length	Set the maximum length for label calibration.	254 mm
BMark Transmitter	This option is used to set upper or lower black mark sensor as the main transmitter.	Back side
Advanced	Set the minimum paper length and maximum gap/bline length for auto-calibration.	0 mm

6.5 Interface

Interface can set the printer interface settings.

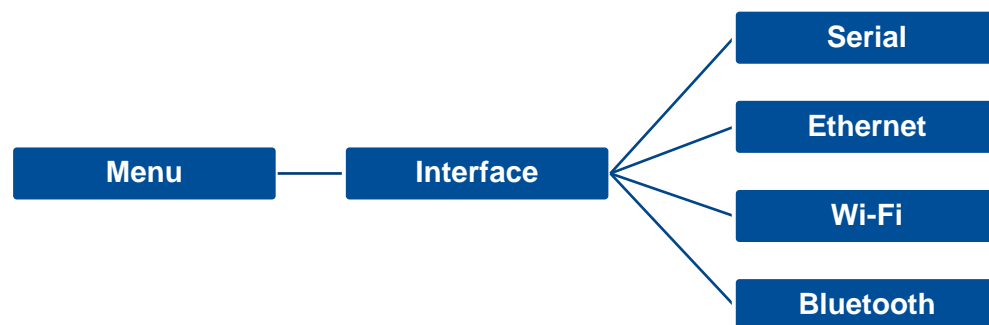

6.5.1 Serial Comm

Serial comm can set the printer RS-232 settings.

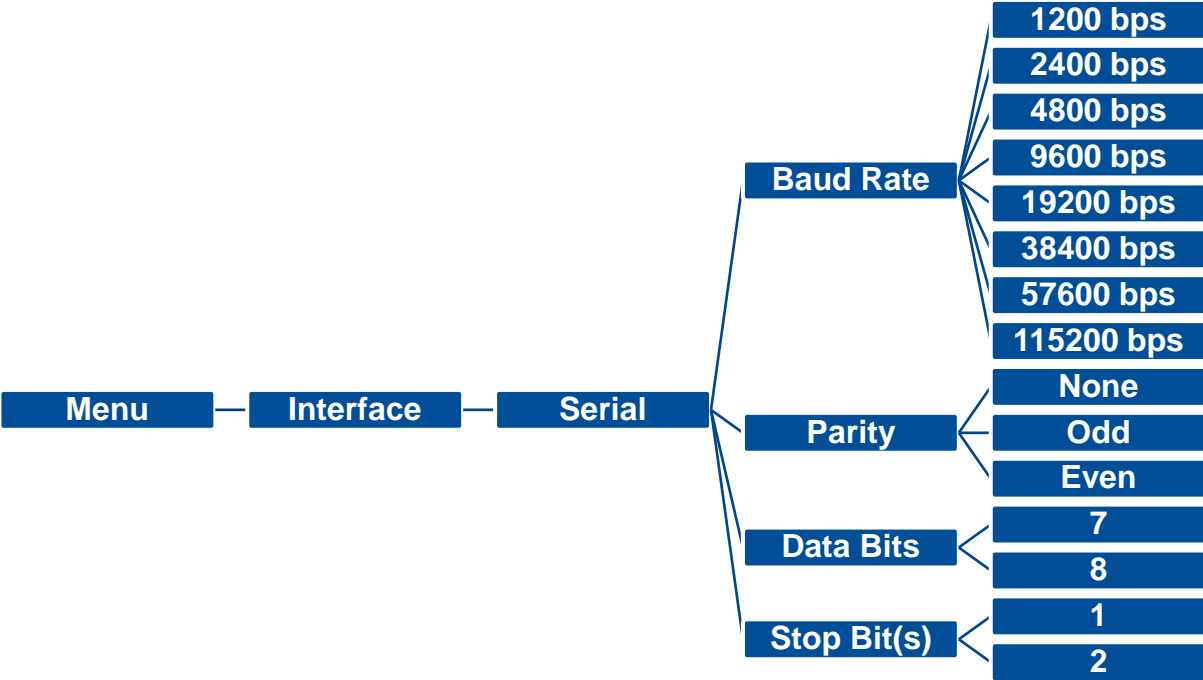

Item	Description	Default
Baud Rate	Set the RS-232 baud rate.	9600
Parity	Set the RS-232 parity.	None
Data Bits	Set the RS-232 Data Bits.	8
Stop Bit(s)	Set RS-232 Stop Bits.	1

6.5.2 Ethernet

Ethernet configures internal Ethernet configuration and checks the printer's Ethernet module status, and reset the Ethernet module.



Item	Description	Default
Status	Check the Ethernet IP address and MAC setting status.	N/A
Config.	DHCP: On or OFF the DHCP (Dynamic Host Configuration Protocol) network protocol. Static IP: Use this menu to set the printer's IP address, subnet mask and gateway.	DHCP

6.5.3 Wi-Fi

Wi-Fi can set the printer Wi-Fi settings.

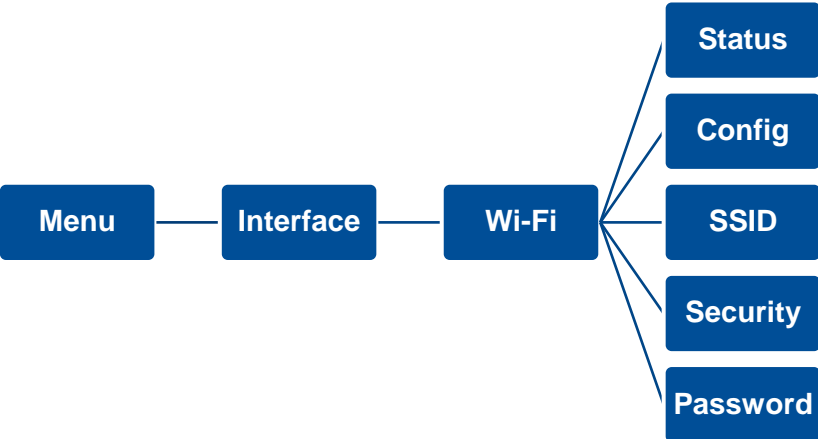

Item	Description	Default
Status	Check the Wi-Fi IP address, MAC setting status,...etc.	N/A
Config.	DHCP: ON/OFF the DHCP (Dynamic Host Configuration Protocol) network protocol. Static IP: Set the printer's IP address, subnet mask and gateway.	DHCP
SSID	Set Wi-Fi SSID.	N/A
Security	Set Wi-Fi security.	Open
Password	Set Wi-Fi password.	N/A

6.5.4 Bluetooth

Bluetooth can set the printer Bluetooth settings.



Item	Description	Default
Status	Check the Bluetooth status.	N/A
Local Name	Set the local name for Bluetooth.	RF-BHS
Ping Code	Set the local ping code for Bluetooth.	0000

6.6 Advanced

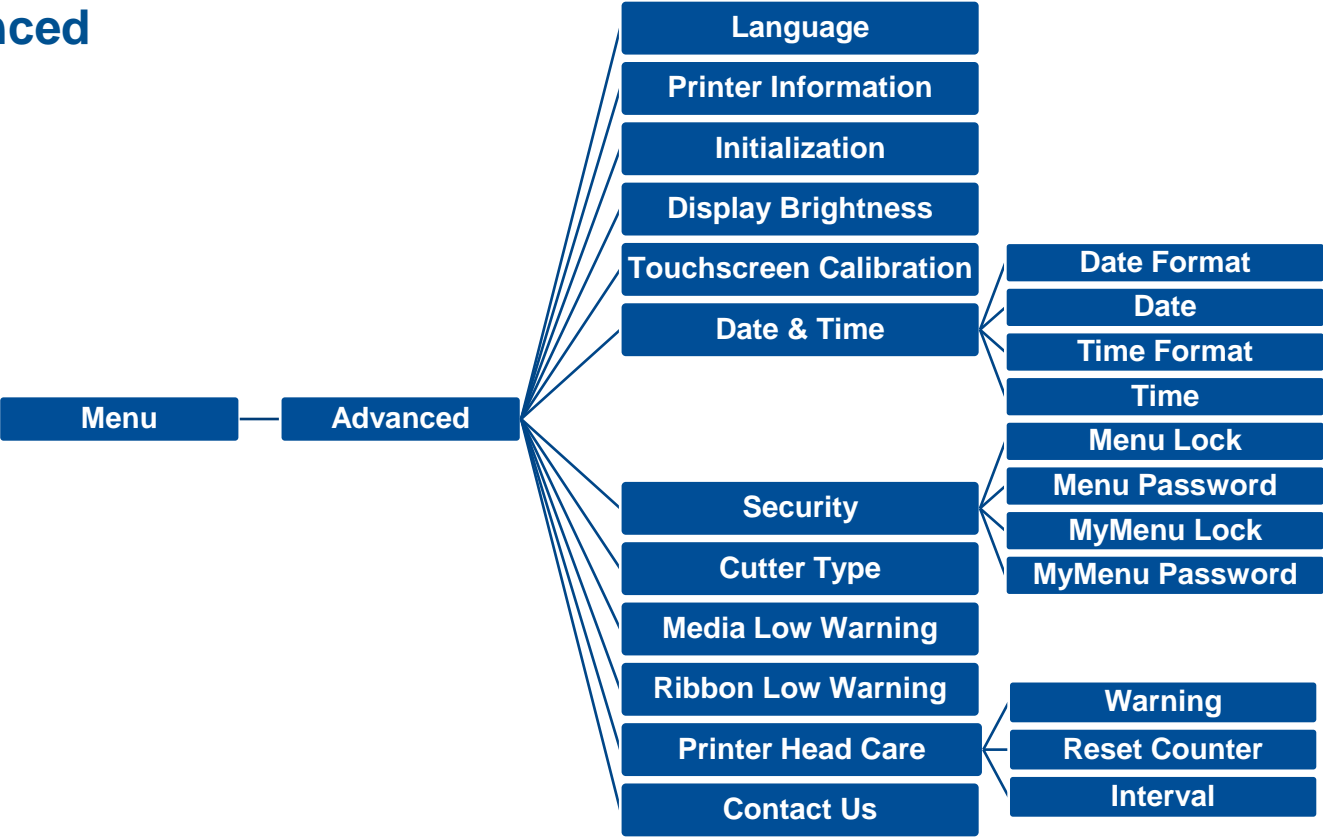

Item	Description	Default
Language	Switch the language on display.	English
Printer Information	Check the printer’s serial number, printed mileage (m), printed labels (pcs) and cutting counter.	N/A
Initialization	Restore printer settings to defaults.	N/A
Display Brightness	Set the brightness for display. Range: 0~100.	50
Touchscreen Calibration	Calibrate the touchscreen for best result.	N/A

Date & Time	Setup the date and time on display.	N/A
Security	Set the password for locking the menu or favorites. The default password is 8888.	Disable
Cutter Type	Set the cutter type.	Guillotine
Ribbon Low Warning	Set the warning for ribbon low. For example, if setting value is 30m, when ribbon capacity was lower than 30m, the  will be shown in red.	30M
	Check print head status and to set the settings for print head care.	
	Warning: Enable/disable the print head clean warning. If enable this feature, once print head has been reached the setting mileage then the warning icon will be shown on printer UI for reminding user to clean the print head. The default setting is disable.	
Printer Head Maintn	Reset Counter: Reset the print head clean warning mileage after cleaning print head.	N/A
	Interval: This item is used to set the expected mileage for reminding user to clean the print head. You have to enable the “TPH warning lock” for use. The default setting is 1 km.	
	Key sound: This item is used to enable/disable the sound of front panel buttons.	
Contact us	Check the contact information for tech support service	N/A

6.7 File Manager

File Manager is used to check the printer available memory, show the files list, delete the files or run the files that saved in the printer DRAM/Flash/Card memory.



6.8 Diagnostic

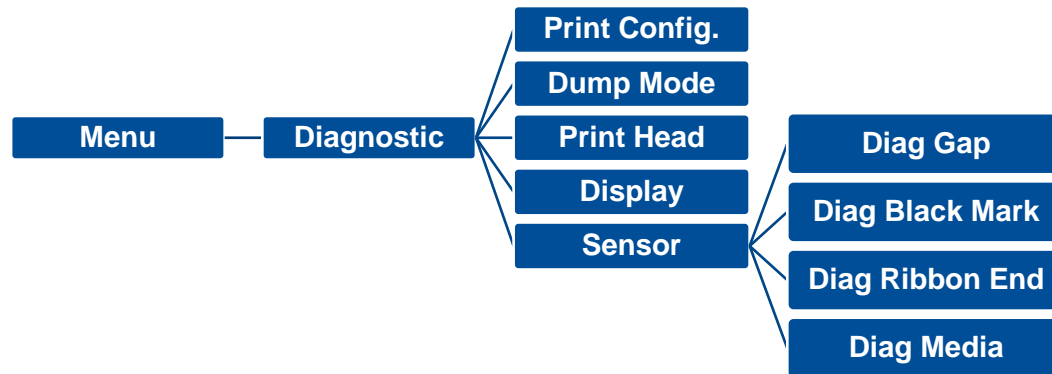

```

DOWNLOA 0D 0A 44 4F 57 4E 4C 4F 4I
D „TEST2. 44 20 22 54 45 53 54 32 2E
DAT“,5,CL 44 41 54 22 2C 35 2C 43 4C
S DOWNLO 53 0D 0A 44 4F 57 4E 4C 4F
AD F,“TES 41 44 20 46 2C 22 54 45 53
T4.DAT“,5 54 34 2E 44 41 54 22 2C 35
,CLS DOW 2C 43 4C 53 0D 0A 44 4F 57
NLOAD „TE 4E 4C 4F 41 44 20 22 54 45
ST2.DAT“, 53 54 32 2E 44 41 54 22 2C
5,CLS DO 35 2C 43 4C 53 0D 0A 44 4F
WNLOAD F, 57 4E 4C 4F 41 44 20 46 2C
„TEST4.DA 22 54 45 53 54 34 2E 44 41
T“,5,CLS 54 22 2C 35 2C 43 4C 53 0D
DOWNLOAD 0A 44 4F 57 4E 4C 4F 41 44
“TEST2.D 20 22 54 45 53 54 32 2E 44
AT“,5,CLS 41 54 22 2C 35 2C 43 4C 53
DOWNLOA 0D 0A 44 4F 57 4E 4C 4F 4I
D F,“TEST 44 20 46 2C 22 54 45 53 54
4.DAT“,5, 34 2E 44 41 54 22 2C 35 2C
CLS 43 4C 53 0D 0A
  
```

Item

Description

Print Config.

Print current printer configuration to the label. The configuration printout contains print head test pattern, which is useful for checking the dot damage on the print head heater.

Dump Mode

Captures the data from the communications port and prints out the data received by printer. In the dump mode, all characters will be printed in 2 columns. The left side characters are received from your system and right side data are the corresponding hexadecimal value of the characters. It allows users or engineers to verify and debug the program.

Dump mode requires 4" wide paper width.

Print Head

Check print head's temperature and bad dots.

Display

Check LCD's color state.

Sensor

Check sensors intensity and reading state.

6.9 Favorites

Favorites helps users build a commonly used list. Arrange the commonly used setting options by **Favorites** .

Add items: Touch and hold the item > window of **Join Favorites** will pop up > tap **Yes** to add the item to **Favorites**.

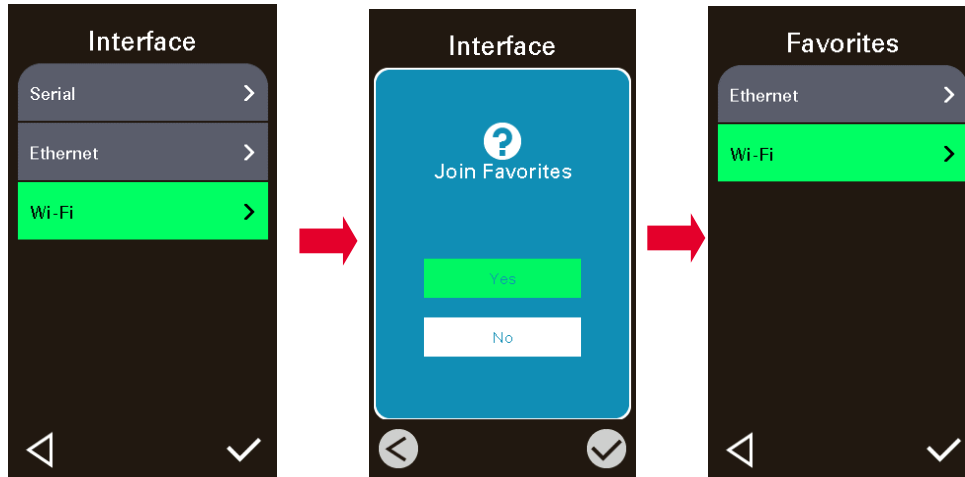

Delete items: Touch and hold the item > window of **Delete Favorites** will pop up > tap **Yes** to delete the item.

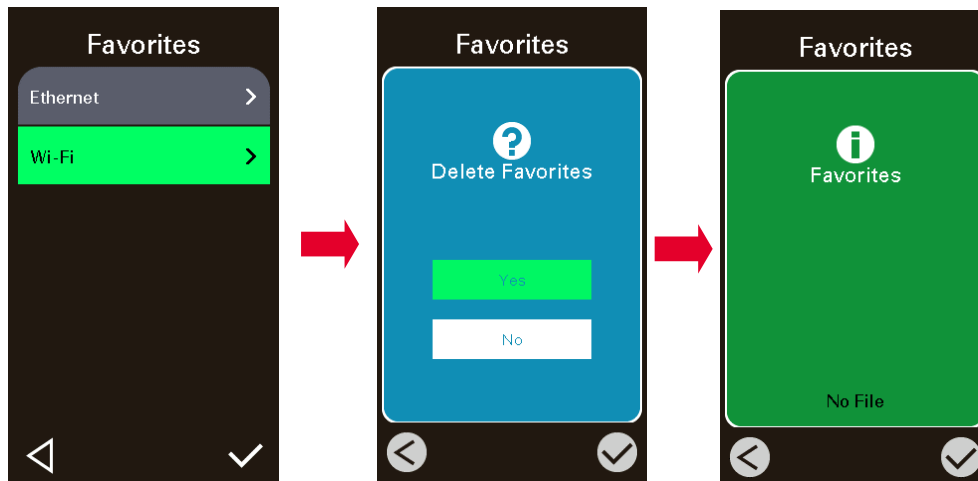

7. Troubleshooting

Problem	Possible Cause	Recovery Procedure
Power indicator does not illuminate	<ul style="list-style-type: none"> ■ The power cord is not properly connected. ■ The power switch is closed. 	<ul style="list-style-type: none"> ■ Plug the power cord in printer and outlet. ■ Switch the printer on.
Carriage Open	<ul style="list-style-type: none"> ■ The printer carriage is open. 	<ul style="list-style-type: none"> ■ Close the print carriage.
Not Printing	<ul style="list-style-type: none"> ■ Check if interface cable is well connected. ■ Check if wireless or Bluetooth device is well connected. ■ The port in the Windows driver is not correct. 	<ul style="list-style-type: none"> ■ Re-connect cable to interface or change a new cable. ■ Reset the wireless device setting. ■ Select the correct printer port in the driver. ■ Clean the printhead. ■ Printhead's harness connector is not well connected with printhead. Turn off the printer and plug the connector again. ■ Check your program if there is a command - PRINT at the end of the file and there must have CRLF at the end of each command line.
No print on the label	<ul style="list-style-type: none"> ■ Label or ribbon is loaded not correctly. ■ Use wrong type paper or ribbon 	<ul style="list-style-type: none"> ■ Follow the instructions in loading the media and ribbon. ■ Ribbon and media are not compatible. ■ Verify the ribbon-inked side. ■ The print density setting is incorrect.
No Ribbon	<ul style="list-style-type: none"> ■ Running out of ribbon. ■ The ribbon is installed incorrectly. 	<ul style="list-style-type: none"> ■ Supply a new ribbon roll. ■ Refer to user's manual to reinstall the ribbon.
No Paper	<ul style="list-style-type: none"> ■ Running out of label. ■ The label is installed incorrectly. ■ Gap/black mark sensor is not calibrated. 	<ul style="list-style-type: none"> ■ Supply a new label roll. ■ Refer to user's manual to reinstall the label roll. ■ Calibrate the gap/black mark sensor.
Paper Jam	<ul style="list-style-type: none"> ■ Gap/black mark sensor is not set properly. ■ Make sure label size is set properly. ■ Labels may be stuck inside the printer 	<ul style="list-style-type: none"> ■ Calibrate the media sensor. ■ Set media size correctly. ■ Remove the stuck label inside the printer mechanism.

mechanism.

Take Label

- Peel function is enabled.

- If peeler module is installed, please remove the label.
- If there is no peeler module in front of the printer, please switch off the printer and install it.
- Check if the connector is plugging correctly.

Can't downloading the file to memory (FLASH / DRAM/CARD)

- The space of memory is full.

- Delete unused files in the memory.

Poor Print Quality

- Ribbon and media is loaded incorrectly.
- Dust or adhesive accumulation on the print head.
- Print density is not set properly.
- Printhead element is damaged.
- Ribbon and media are incompatible.
- The printhead pressure is not set properly.

- Reload the supply.
- Clean the print head.
- Clean the platen roller.
- Adjust the print density and print speed.
- Run printer self-test and check the print head test pattern if there is dot missing in the pattern.
- Change proper ribbon or proper label media.
- Adjust the printhead pressure adjustment knob.
- The release lever does not latch the printhead properly.

Missing printing on the left or right side of label

- Wrong label size setup.

- Set the correct label size.

Gray line on the blank label

- The print head is dirty.
- The platen roller is dirty.

- Clean the print head.
- Clean the platen roller.
- (Please refer to chapter 8)

Irregular printing

- The printer is in Hex Dump mode.
- The RS-232 setting is incorrect.

- Turn off and on the printer to skip the dump mode.
- Re-set the RS-232 setting.

Label feeding is not stable (skew) when printing

- The media guide does not touch the edge of the media.

- If the label is moving to the right side, please move the label guide to left.
- If the label is moving to the left side, please move the label guide to right.

Skip labels when printing

- Label size is not specified properly.

- Check if label size is setup correctly.

	<ul style="list-style-type: none"> ■ Sensor sensitivity is not set properly. ■ The media sensor is covered with dust. 	<ul style="list-style-type: none"> ■ Calibrate the sensor by Auto Gap or Manual Gap options. ■ Clear the GAP/Black mark sensor by blower.
Wrinkle Problem	<ul style="list-style-type: none"> ■ Printhead pressure is incorrect. ■ Ribbon installation is incorrect. ■ Media installation is incorrect. ■ Print density is incorrect. ■ Media feeding is incorrect. 	<ul style="list-style-type: none"> ■ Please refer to the chapter 4. ■ Please set the suitable density to have good print quality. ■ Make sure the label guide touch the edge of the media guide.
RTC time is incorrect when reboot the printer	<ul style="list-style-type: none"> ■ The battery has run down. 	<ul style="list-style-type: none"> ■ Check if there is a battery on the main board.
The left side printout position is incorrect	<ul style="list-style-type: none"> ■ Wrong label size setup. ■ The parameter Shift X in LCD menu is incorrect. 	<ul style="list-style-type: none"> ■ Set the correct label size. ■ Press [Menu] → [Setting] → [Shift X] to fine tune the parameter of Shift X.
The printing position of small label is incorrect	<ul style="list-style-type: none"> ■ Media sensor sensitivity is not set properly. ■ Label size is incorrect. ■ The parameter Shift Y in the LCD menu is incorrect. ■ The vertical offset setting in the driver is incorrect. 	<ul style="list-style-type: none"> ■ Calibrate the sensor sensitivity again. ■ Set the correct label size and gap size. ■ Press [Menu] → [Setting] → [Shift Y] → to fine tune the parameter of Shift Y. ■ Set the vertical offset in the driver if you're using BarTender.
LCD panel is dark and keys are not working	<ul style="list-style-type: none"> ■ The cable between main PCB and LCD panel is loose. 	<ul style="list-style-type: none"> ■ Check if the cable between main PCB and LCD is secured or not.
LCD panel is dark but the LEDs are light	<ul style="list-style-type: none"> ■ The printer initialization is unsuccessful. 	<ul style="list-style-type: none"> ■ Turn OFF and ON the printer again. ■ Initialize the printer.
Ribbon encoder sensor doesn't work	<ul style="list-style-type: none"> ■ The ribbon encoder sensor connector is loose. 	<ul style="list-style-type: none"> ■ Fasten the connector.
Ribbon end sensor doesn't work	<ul style="list-style-type: none"> ■ The connector is loose. ■ The ribbon sensor hole is covered with dust. 	<ul style="list-style-type: none"> ■ Check the connector. ■ Clear the dust in the sensor hole by the blower.
Cutter is not working	<ul style="list-style-type: none"> ■ The connector is loose. 	<ul style="list-style-type: none"> ■ Plug in the connect cable correctly.

8. Maintenance

This session presents the clean tools and methods to maintain the printer.

■ For Cleaning

Depending on the media used, the printer may accumulate residues (media dust, adhesives, etc.) as a by-product of normal printing. To maintain the best printing quality, you should remove these residues by cleaning the printer periodically. Regularly clean the print head and supply sensors once change a new media to keep the printer at the optimized performance and extend printer life.

■ For Disinfecting

Sanitize your printer to protect yourself and others and can help prevent the spread of viruses.

■ Important

- Set the printer power switch to O (Off) prior to performing any cleaning or disinfecting tasks. Leave the power cord connected to keep the printer grounded and to reduce the risk of electrostatic damage.
- Do not wear rings or other metallic objects while cleaning any interior area of the printer.
- Use only the cleaning agents recommended in this document. Use of other agents may damage the printer and void its warranty.
- Do not spray or drip liquid cleaning solutions directly into the printer. Apply the solution on a clean lint-free cloth and then apply the dampened cloth to the printer.
- Do not use canned air in the interior of the printer as it can blow dust and debris onto sensors and other critical components.
- Only use a vacuum cleaner with a nozzle and hose that are conductive and grounded to drain off static build up.
- All reference in these procedures for use of isopropyl alcohol requires that a 99% or greater isopropyl alcohol content be used to reduce the risk of moisture corrosion to the printhead.
- Do not touch printhead by hand. If you touch it carelessly, please use 99% Isopropyl alcohol to clean it.
- Always taking personal precaution when using any cleaning agent.

Cleaning Tools

- Cotton swab
- Lint-free cloth
- Brush with soft non-metallic bristles
- Vacuum cleaner
- 75% Ethanol (for disinfecting)
- 99% Isopropyl alcohol (for printhead and platen roller cleaning)
- Genuine printhead cleaning pen
- Mild detergent (without chlorine)

Cleaning Process:

Printer Part	Method	Interval
Print Head	<ol style="list-style-type: none"> I. Always turn off the printer before cleaning the printhead. II. Allow the printhead to cool for at least one minute. III. Use a cotton swab and 99% Isopropyl Alcohol or genuine print head cleaning pen to clean the print head surface. 	Clean the print head when changing a new label roll.
Platen Roller	<ol style="list-style-type: none"> I. Turn off the printer. II. Rotate the platen roller and wipe it thoroughly with the lint-free 99% Isopropyl Alcohol. 	Clean the platen roller when changing a new label roll
Peel Bar	Use the lint-free cloth with 99% Isopropyl Alcohol to wipe it.	As needed
Sensor	Use brush with soft non-metallic bristles or a vacuum cleaner, to remove paper dust. Clean upper and lower media sensors to ensure reliable Top of Form and Paper Out sensing.	Monthly
Exterior	Clean the exterior surfaces with a clean, lint-free cloth (water-dampened cloth). If necessary, use a mild detergent or desktop cleaning solution then use the 75% Ethanol to wipe it.	As needed
Interior	Clean the interior of the printer by removing any dirt and lint with a vacuum cleaner, as described above, or use a brush with soft non-metallic bristles then use the 75% Ethanol to wipe it.	As needed

9. Agency Compliance and Approvals



EN 55032: Class A

EN 55024

EN 60950-1

EN 62368

This is a class A product. In a domestic environment this product may cause radio interference in which case the user may be required to take adequate measures.

FCC part 15B, Class A

ICES-003, Class A

This equipment has been tested and found to comply with the limits for a Class A digital device, pursuant to Part 15 of the FCC Rules. These limits are designed to provide reasonable protection against harmful interference when the equipment is operated in a commercial environment.



Operation is subject to the following two conditions: (1) This device may cause harmful interference, and (2) this device must accept any interference received, including interference that may cause undesired operation.

This equipment generates, uses, and can radiate radio frequency energy and, if not installed and used in accordance with the manufacturer's instruction manual, may cause harmful interference with radio communications. Operation of this equipment in a residential area is likely to cause harmful interference, in which case you will be required to correct the interference at your own expense.

This Class A digital apparatus complies with Canadian ICES-003.

Cet appareil numérique de la classe A est conforme à la norme NMB-003 du Canada.



AS/NZS CISPR 32, Class A

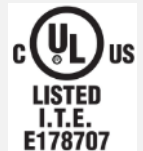

UL 60950-1 (2nd Edition)

CSA C22.2 No. 60950-1-07 (2nd Edition)

UL 62368-1, 2nd Edition, 2014-12-01 (Audio/video, Information and Communication Technology Equipment - Part 1: Safety Requirements) CAN/CSA C22.2 No. 62368-1-14, 2nd Edition, 2014-12 (Audio/video, Information and Communication Technology Equipment - Part 1: Safety Requirements)



EN 62368-1:2014/A11:2017



KN 32

KN 35

K60950-1(2011-12)

이 기기는 업무용(A 급) 전자파적합기기로서 판매자 또는 사용자는 이 점을 주의하시기 바라며, 가정외의 지역에서 사용하는 것을 목적으로 합니다.



GB 4943.1

GB/T9254, Class A

GB 17625.1

此为 A 级产品，在生活环境中，该产品可能会造成无线电干扰，在这种情况下，可能需要用户对干扰采取切实可行的措施。



Energy Star for Imaging Equipment Version 3.0



IS 13252(Part 1)/

IEC 60950-1

Note: There may have certification differences in the series models, please refer to product label for accuracy.

Important safety instructions:

1. Read all of these instructions and keep them for later use.
2. Follow all warnings and instructions on the product.
3. Disconnect the power from the AC inlet before cleaning or if fault happened.
Do not use liquid or aerosol cleaners. Using a damp cloth is suitable for cleaning.
4. The mains socket shall be installed near the equipment and easily accessible.
5. The unit must be protected against moisture.
6. Ensure the stability when installing the device, Tipping or dropping could cause damage.
7. Make sure to follow the correct power rating and power type indicated on marking label provided by manufacture.

8. Please refer to user manual for maximum operation ambient temperature provided by manufacture.



WARNING:

Moving parts. Keep finger or body away from moving parts.

CAUTION:

(For equipment with RTC (CR2032) battery or rechargeable battery pack)

Risk of explosion if battery is replaced by an incorrect type.

Dispose of used batteries according to the Instructions as below.

1. DO NOT throw the battery in fire.
2. DO NOT short circuit the contacts.
3. DO NOT disassemble the battery.
4. DO NOT throw the battery in municipal waste.
5. The symbol of the crossed out wheeled bin indicates that the battery should not be placed in municipal waste.



Caution: Hot surface for printhead.

Do not touch the printhead before it cooling.

WARNING:

Remove the power from AC inlet before opening the media cover for cleaning or repairing faults. After cleaning or fixing faults, media cover closing before power connecting to AC inlet.

CAUTION:

Any changes or modifications not expressly approved by the grantee of this device could void the user's authority to operate the equipment.

CE Statement:

This equipment complies with EU radiation exposure limits set forth for an uncontrolled environment. This equipment should be installed and operated with minimum distance 20 cm between the radiator & your body.

All operational modes:

2.4GHz: 802.11b, 802.11g, 802.11n (HT20), 802.11n (HT40)

5GHz: 802.11a,

The frequency, mode and the maximum transmitted power in EU are listed below:

2400 MHz – 2483.5 MHz: 19.88 dBm (EIRP)

5150 MHz – 5250 MHz: 17.51 dBm (EIRP)

5150-5350MHz for Only indoor use

5470-5725MHz for indoor/outdoor use

Restrictions In AZE

National restrictions information is provided below

Frequency Band	Country	Remark
5150-5350MHz	Azerbaijan	No license needed if used indoor and power not exceeding 30mW
5470-5725MHz		

Hereby, TSC Auto ID Technology Co., Ltd. declares that the radio equipment type [Wi-Fi] IEEE 802.11 a/b/g/n is in compliance with Directive 2014/53/EU

The full text of the EU declaration of conformity is available at the following internet address: [http:// www.tscprinters.com](http://www.tscprinters.com)

RF exposure warning (Wi-Fi)

This equipment must be installed and operated in accordance with provided instructions and must not be co-located or operating in conjunction with any other antenna or transmitter. End-users and installers must be providing with antenna installation instructions and transmitter operating conditions for satisfying RF exposure compliance.

SAR Value: 0.736 W/kg

RF exposure warning (For Bluetooth)

The equipment complies with FCC RF exposure limits set forth for an uncontrolled environment.
The equipment must not be co-located or operating in conjunction with any other antenna or transmitter.

Canada, Industry Canada (IC) Notices

This Class B digital apparatus complies with Canadian ICES-003 and RSS-210.

Operation is subject to the following two conditions: (1) this device may not cause interference, and (2) this device must accept any interference, including interference that may cause undesired operation of the device.

Radio Frequency (RF) Exposure Information

The radiated output power of the Wireless Device is below the Industry Canada (IC) radio frequency exposure limits. The Wireless Device should be used in such a manner such that the potential for human contact during normal operation is minimized.

This device has been evaluated for and shown compliant with the IC Specific Absorption Rate (“SAR”) limits when installed in specific host products operated in portable exposure conditions. **(For Wi-Fi)**

This device has also been evaluated and shown compliant with the IC RF Exposure limits under portable exposure conditions. (Antennas are less than 20 cm of a person's body). **(For Bluetooth)**

Canada, avis de l'Industry Canada (IC)

Cet appareil numérique de classe B est conforme aux normes canadiennes ICES-003 et RSS-210.

Son fonctionnement est soumis aux deux conditions suivantes : (1) cet appareil ne doit pas causer d'interférence et (2) cet appareil doit accepter toute interférence, notamment les interférences qui peuvent affecter son fonctionnement.

Informations concernant l'exposition aux fréquences radio (RF)

La puissance de sortie émise par l'appareil sans fil est inférieure à la limite d'exposition aux fréquences radio de l'Industry Canada (IC). Utilisez l'appareil sans fil de façon à minimiser les contacts humains lors du fonctionnement normal.

Ce périphérique a été évalué et démontré conforme aux limites SAR (Specific Absorption Rate – Taux d'absorption spécifique) par

l'IC lorsqu'il est connecté à des dispositifs hôtes spécifiques opérant dans des conditions d'utilisation mobile. **(Pour le Wi-Fi)**

Ce périphérique a également été évalué et démontré conforme aux limites d'exposition radio-fréquence par l'IC pour des utilisations par des opérateurs mobiles (les antennes sont à moins de 20 cm du corps d'une personne). **(Pour le Bluetooth)**

NCC 警語:

經型式認證合格之低功率射頻電機，非經許可，公司、商號或使用者均不得擅自變更頻率、加大功率或變更原設計之特性及功能。(即

低功率電波輻射性電機管理辦法第十二條)

低功率射頻電機之使用不得影響飛航安全及干擾合法通信；經發現有干擾現象時，應立即停用，並改善至無干擾時方得繼續使用。

前項合法通信，指依電信法規定作業之無線電通信。低功率射頻電機須忍受合法通信或工業、科學及醫療用電波輻射性電機設備之干

擾。(即低功率電波輻射性電機管理辦法第十四條)

For MFi Bluetooth



Use of the Made for Apple badge means that an accessory has been designed to connect specifically to the Apple product(s) identified in the badge, and has been certified by the developer to meet Apple performance standards. Apple is not responsible for the operation of this device or its compliance with safety and regulatory standards.

For US Model

Made for iPhone®XS Max, iPhone XS, iPhone XR, iPhone X, iPhone 8, iPhone 8 Plus, iPhone 7, iPhone 7 Plus, iPhone SE, iPhone 6s, iPhone 6s Plus, iPhone 6, iPhone 6 Plus, iPhone 5s, iPad Pro® 12.9-inch (2nd generation), iPad Pro 10.5-inch, iPad® (6th generation), iPad (5th generation), iPad Pro 9.7-inch, iPad Pro 12.9-inch (1st generation), iPad Air® 2, iPad mini™ 4, iPad mini 3, iPad Air, iPad mini 2, iPod touch® (6th generation)

iPad, iPad Air, iPad Pro, iPhone are trademarks of Apple Inc., registered in the U.S. and other countries.

For JP Model

Made for iPhone XS Max, iPhone XS, iPhone XR, iPhone X, iPhone 8, iPhone 8 Plus, iPhone 7, iPhone 7 Plus, iPhone SE, iPhone 6s, iPhone 6s Plus, iPhone 6, iPhone 6 Plus, iPhone 5s, iPad Pro 12.9-inch (2nd generation), iPad Pro 10.5-inch, iPad (6th generation), iPad (5th generation), iPad Pro 9.7-inch, iPad Pro 12.9-inch (1st generation), iPad Air 2, iPad mini 4, iPad mini 3, iPad Air, iPad mini 2, iPod touch (6th generation)

iPad, iPad Air, iPad Pro, iPhone are trademarks of Apple Inc., registered in the U.S. and other countries. The trademark “iPhone” is used in Japan with a license from Aiphone K.K.

Except for US, JP Model

Made for iPhone XS Max, iPhone XS, iPhone XR, iPhone X, iPhone 8, iPhone 8 Plus, iPhone 7, iPhone 7 Plus, iPhone SE, iPhone 6s, iPhone 6s Plus, iPhone 6, iPhone 6 Plus, iPhone 5s, iPad Pro 12.9-inch (2nd generation), iPad Pro 10.5-inch, iPad (6th generation), iPad (5th generation), iPad Pro 9.7-inch, iPad Pro 12.9-inch (1st generation), iPad Air 2, iPad mini 4, iPad mini 3, iPad Air, iPad mini 2, iPod touch (6th generation)

iPad, iPad Air, iPad Pro, iPhone are trademarks of Apple Inc., registered in the U.S. and other countries.

10. Revise History

Date	Content	Editor
2022/4/6	Modify printer spec section's cell position to match the information	Linda

TSC **PRINTRONIX**[®]
AUTO ID