

Industrial Barcode Printers

# MH241 Series

*Thermal Transfer • Direct Thermal*

## Series Models

MH241/MH341/MH641

MH241T/MH341T/MH641T

MH241P/MH341P/MH641P



Service Manual

# Copyright Information

**©2022 TSC Auto ID Technology Co., Ltd.**

The copyright in this manual, the software and firmware in the printer described are owned by TSC Auto ID Technology Co., Ltd. All rights reserved.

CG Triumvirate is a trademark of Agfa Corporation. CG Triumvirate Bold Condensed font is under license from the Monotype Corporation. Windows is a registered trademark of Microsoft Corporation.

All other trademarks are the property of their respective owners. Information in this document is subject to change without notice and does not represent a commitment on the part of TSC Auto ID Technology Co. No part of this manual may be reproduced or transmitted in any form or by any means, for any purpose other than the purchaser's personal use, without the expressed written permission of TSC Auto ID Technology Co.



# Table of Contents

<b>1. Fundamental of the System</b> .....	1
1.1 Printer Overview .....	1
<b>2. Electronics</b> .....	5
2.1 Summary of the Board Connectors .....	5
2.2 Interface Pin Configuration.....	7
<b>3. Mechanism</b> .....	9
3.1 Remove the Lower Front Panel.....	9
3.2 Remove the Electronics Cover .....	10
3.3 Replacing the Power Supply Unit.....	11
3.4 Removing the Media Cover.....	12
3.5 Replacing the Platen Roller Assembly .....	13
3.6 Replacing the Print head ASS'Y.....	15
3.7 Replacing the LCD Panel Cover Assembly .....	17
3.8 Replacing the LCD Control Board & LCD Touch Panel.....	18
3.9 Replacing Front Panel Buttons Control Board.....	19
3.10 Replacing the Label Supply Spindle (3" and 1") .....	20
3.11 Replacing the Internal Rewinder DC Motor .....	22
3.12 Replacing GPIO Interface Board (with Parallel Port) .....	23

- 3.13 Replacing the Main Board .....25
- 3.14 Replacing the Stepping Motor Assembly .....26
- 3.15 Replacing the Gap/Black Mark Sensor Module .....27
- 3.16 Cutter Module Installation (Option).....28
- 3.17 Peel-off Kit Installation (Option).....30
- 3.18 Slot-in Wireless Housing Installation (Option) .....35
- 3.19 Replacing the Bluetooth module .....38
- 3.20 Care Label Cutter Module Installation (Option) .....40
- 3.21 Internal Rewinder Module Installation (Option, MH241/MH241T Series Only).....42
- 4. Troubleshooting .....47**
  - 4.1 Knob Adjustment.....50
  - 4.2 Ribbon Tension Adjustment Knob.....51
  - 4.3 Mechanism Fine Adjustment to Avoid Ribbon Wrinkles.....52
- 5. Maintenance .....55**
- Revision History .....57**

# 1. Fundamental of the System

## 1.1 Printer Overview

### ◆ Front View

#### MH241 Series



1. LED indicator
2. LCD display
3. Front panel buttons
4. USB host x 2
5. Media view window
6. Paper exit chute
7. Media cover handle

#### MH241T Series



1. LED indicator
2. LCD display
3. Front panel buttons
4. USB host x 2
5. Media view window
6. Paper exit chute
7. Media cover handle

#### MH241P Series



1. LED indicator
2. LCD display
3. Front panel buttons
4. USB host x 2
5. Media view window
6. Paper exit chute
7. Media cover handle
8. Media lower cover

◆ Interior View

MH241/MH241T Series

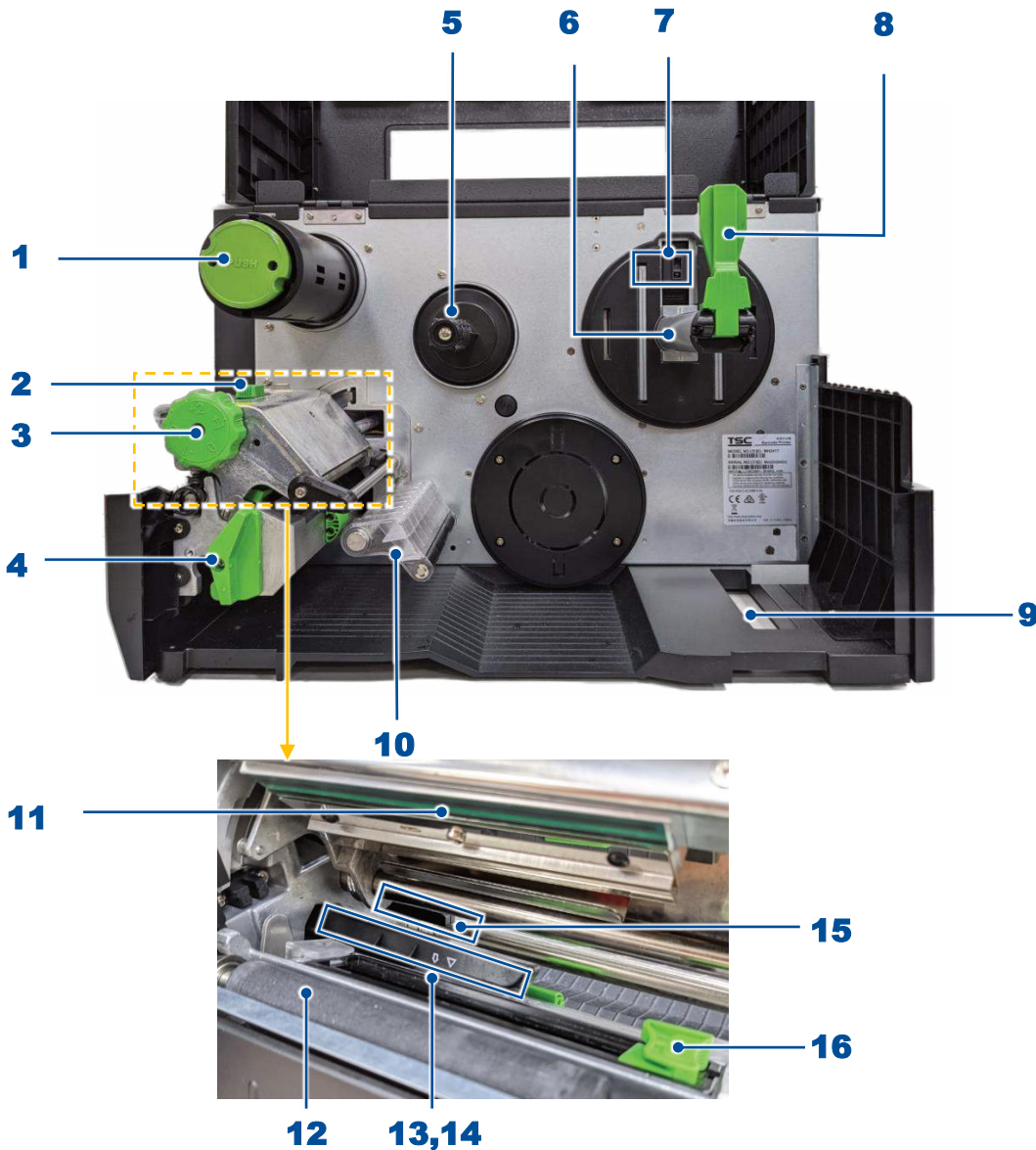

- 1. Ribbon rewind spindle
- 2. Print head pressure position adjustment knob
- 3. Print head pressure adjustment knob
- 4. Print head release lever
- 5. Ribbon supply spindle
- 6. Label supply spindle
- 7. Media near end sensor  
(movable, MH241T Series only)
- 8. Label roll guard
- 9. External label entrance chute
- 10. Damper
- 11. Print head
- 12. Platen roller
- 13. Black mark sensor (shown as ↓)
- 14. Gap sensor (shown as ▽)
- 15. Ribbon sensor
- 16. Front label guide



For MH241P Series

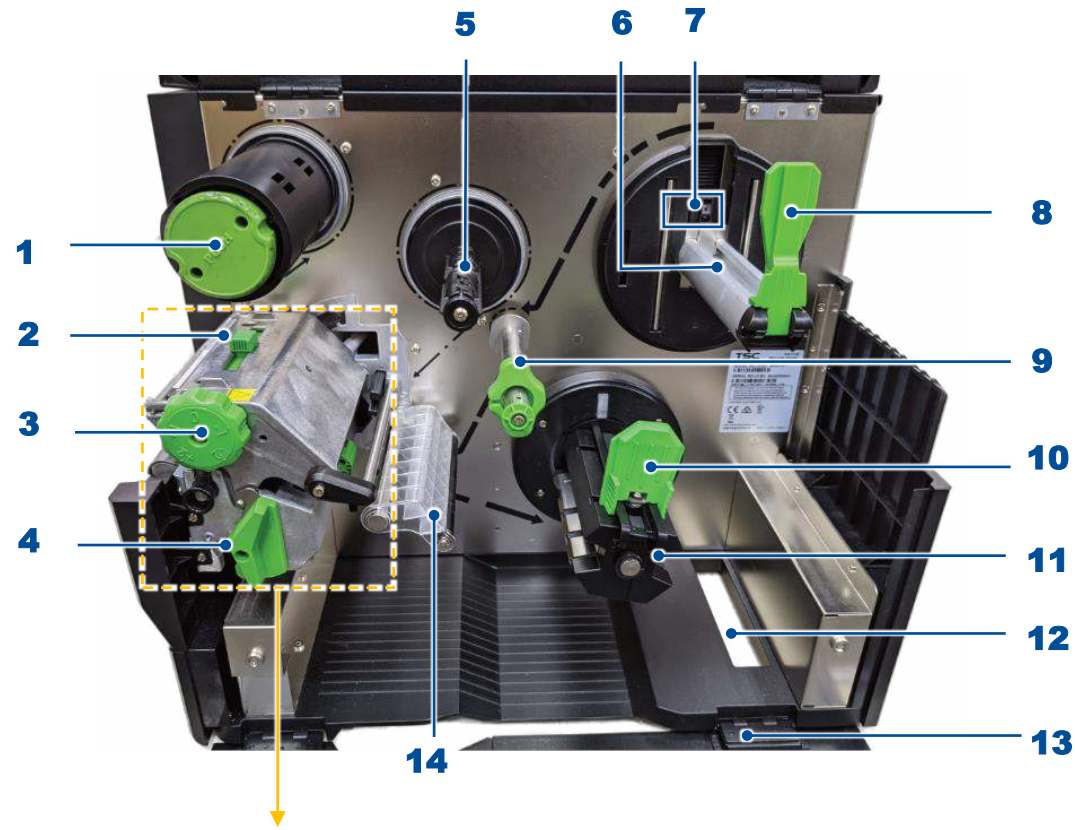

- 1. Ribbon rewind spindle
- 2. Print head pressure position adjustment knob
- 3. Print head pressure adjustment knob
- 4. Print head release lever
- 5. Ribbon supply spindle
- 6. Label supply spindle
- 7. Media near end sensor (movable, MH241T/MH241P Series only)
- 8. Label roll guard
- 9. Media guide bar & rear label guide
- 10. Media rewind guide
- 11. Media rewind spindle
- 12. External label entrance chute
- 13. Media lower cover
- 14. Damper

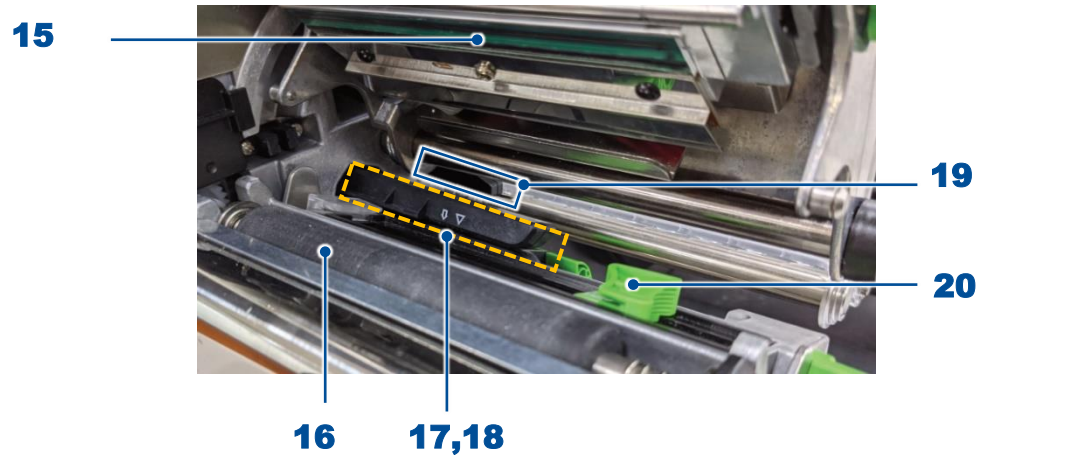

◆ Rear View

**MH241/MH241T Series**

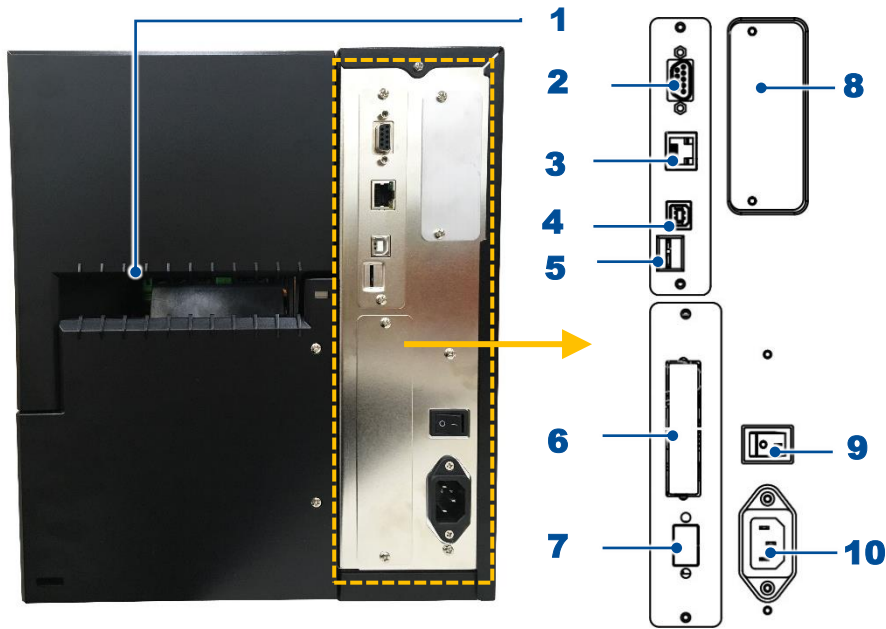

1. External label entrance chute
2. RS-232C interface
3. Ethernet interface
4. USB interface
5. microSD card slot
6. Centronics interface (Option)
7. GPIO interface (Option)
8. Slot-in Wi-Fi interface (Option)
9. Power switch
10. Power cord socket

**MH241P Series**

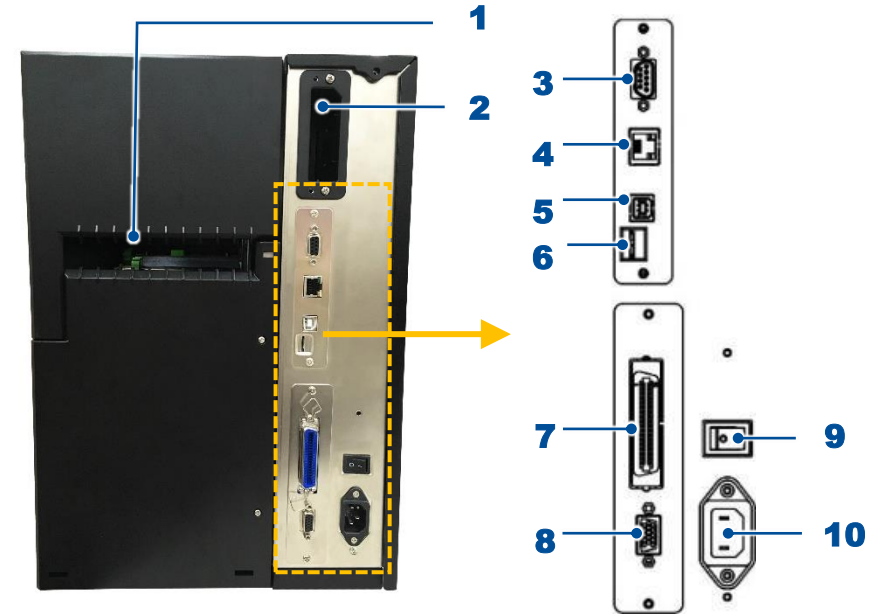

1. External label entrance chute
2. Slot-in Wi-Fi module (Option)
3. RS-232C interface
4. Ethernet interface
5. USB interface
6. microSD card slot
7. Centronics interface (Option)
8. Power switch
9. Power cord socket
10. GPIO interface (Option)

Note: The interface picture here is for reference only. Please refer to the product specification for the interface availability.



# 2. Electronics

## 2.1 Summary of the Board Connectors

Main board for MB240/ MB240T Series

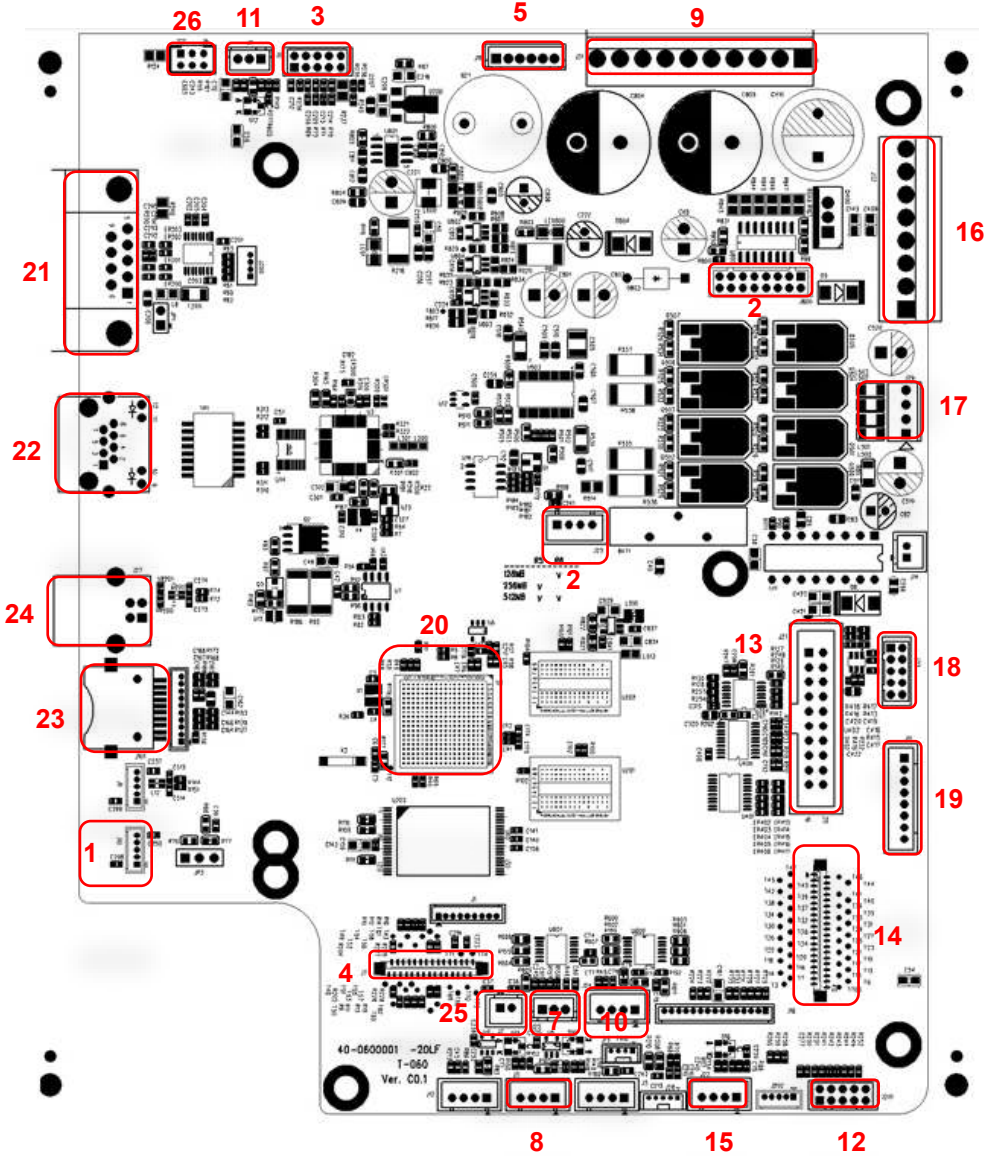

Connector	Description
1	USB Host connector
2	Power supply output (5V/36V DC) connector
3	Wi-Fi Module connector
4	Parallel Port board connector
5	GPIO interface board connector
6	Head open sensor connector
7	Gap sensor connector
8	Ribbon encoder sensor connector
9	Power supply output (24V DC) connector
10	Lower BM Sensor connector
11	Paper Distance Sensor connector
12	BT module connector
13	Print head connector
14	LCD panel connector
15	Ribbon end sensor connector
16	TPH Power (24V DC) connector
17	Stepping motor connector
18	Cutter/peel-off connector
19	Paper REWIND connector
20	Micro processor
21	RS-232C connector
22	Ethernet interface
23	MICRO SD card socket
24	USB interface
25	Upper BM Sensor Connector
26	Wi-Fi interface

## 2.2 Interface Pin Configuration

### RS-232C

PIN	CONFIGURATION
1	+5 V
2	TXD
3	RXD
4	CTS
5	GND
6	RTS
7	N/C
8	RTS
9	N/C

### USB Device

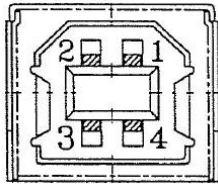

PIN	CONFIGURATION
1	N/C
2	D-
3	D+
4	GND

## Ethernet

PIN	CONFIGURATION
1	Tx+
2	Tx-
3	Rx+
4	N/C
5	N/C
6	Rx-
7	N/C
8	N/C

## Cutter/peel-off Sensor Connector

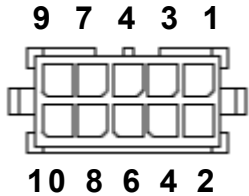
	Pin	Description	Voltage
	1	Cutter enable	0V: Cutter work 5V: Cutter stop
	2	Cutter direction	0V: Cutter positive cut 5V: Cutter negative cut
	3	Cutter position sensor switch	0V: Cutter stop 3.3V: Cutter work
	4	Peel sensor receiver	A/D: 0~3.3V
	5	N/A	N/A
	6	Logic power	5V
	7	GND	0V
	8	Cutter power	24V
	9	I2C SCL signal	
	10	I2C SDA signal	

## 3. Mechanism

### 3.1 Remove the Lower Front Panel

1. Open the media cover.
2. Remove 2 screws (fastened by  $7.5 \text{ kg} \pm 15\% \text{ kg-cm}$ ) and pull out the lower front panel.
3. Reassemble the parts in the reverse procedures.

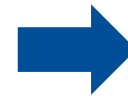
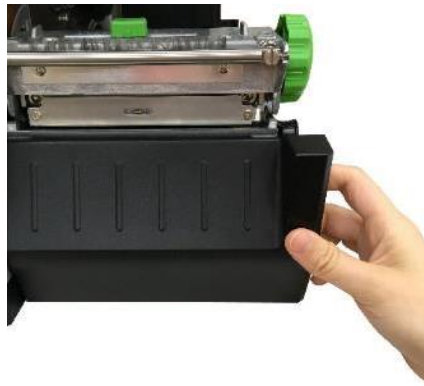
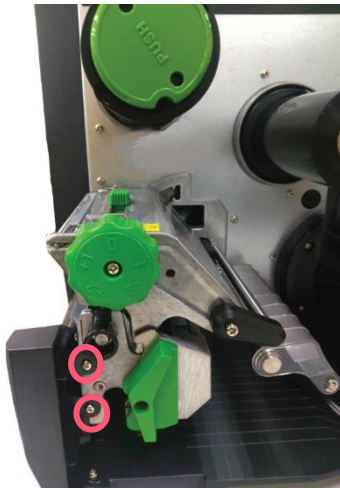

Lower front panel



## 3.2 Remove the Electronics Cover

1. Turn the printer to backside and remove one screw (fastened by  $5\text{ kg}\pm 15\%$  kg-cm) on the electronic cover.
2. Turn back the printer to front side and push the electronics cover forward to leave the loading slot, then pull up the cover with both hands to release the mechanism.

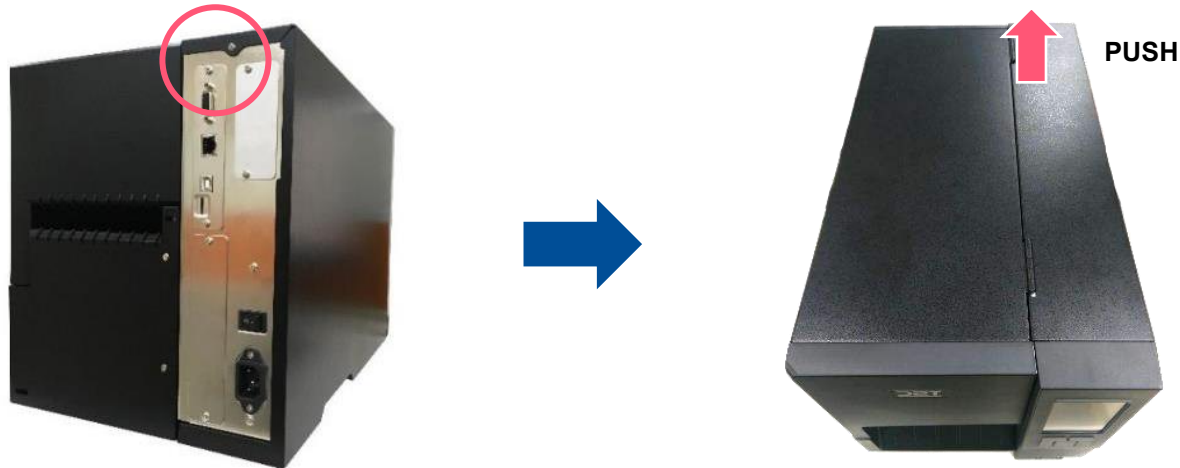

3. Remove the electronic cover.

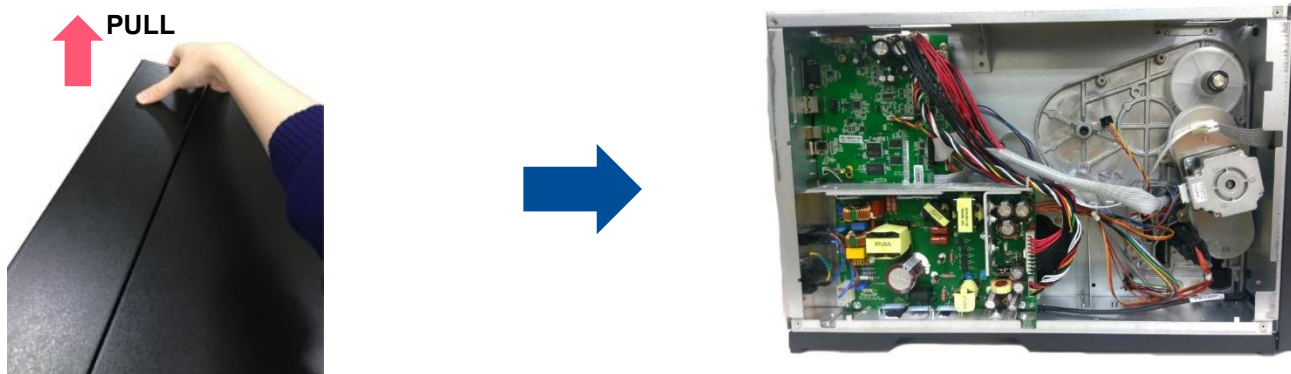

4. Reassemble the parts in the reverse procedures.

### 3.3 Replacing the Power Supply Unit

1. Refer to section 3.2 to remove the electronics cover.
2. Remove 5 screws (fastened by 7.5 kg±15% kg-cm) as indicated below.

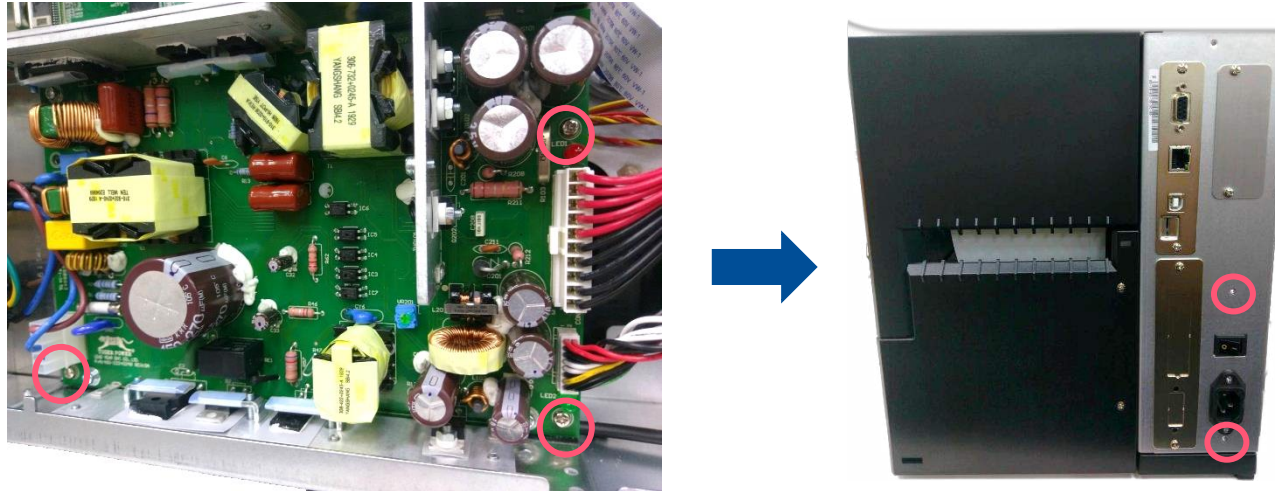

3. Remove cables.

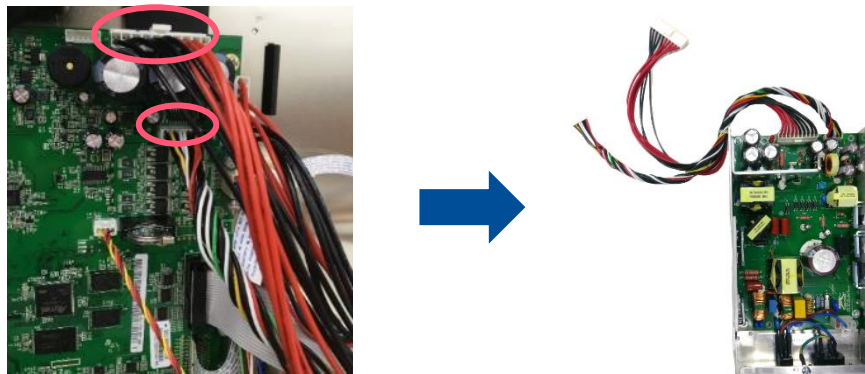

4. Remove/Replace the power supply unit.
5. Reassemble the parts in the reverse procedures.

### 3.4 Removing the Media Cover

1. Open the media cover and remove 4 screws (fastened by  $5\text{ kg}\pm 15\% \text{ kg-cm}$ ) from each hinge. Be careful the media cover may fall out from the printer when all screws are disengaged.
2. Take out the media cover from the printer.
3. Reassemble the parts in the reverse procedures.



## 3.5 Replacing the Platen Roller Assembly

1. Open the printer cover.
2. Push the print head release lever to open the print head mechanism.

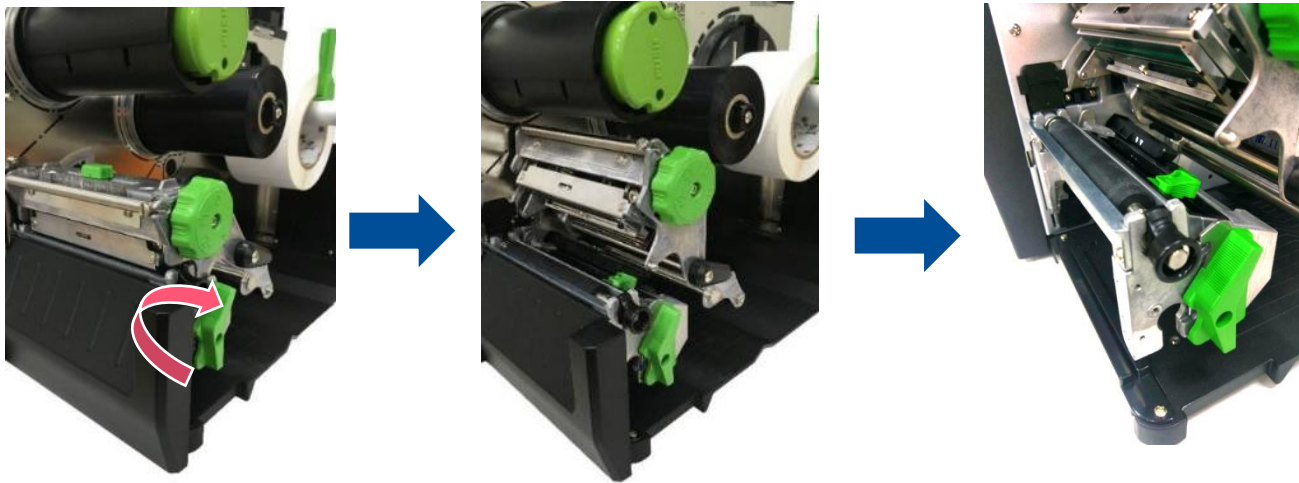

3. Refer to section 3.1 to remove the lower front panel.





4. Use tools to Remove the platen roller dust cap as indicated.

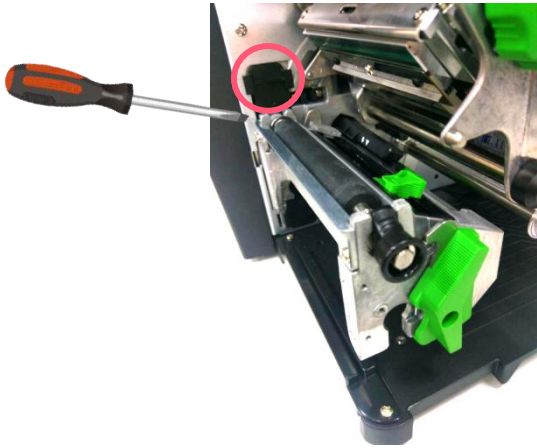

5. Pull up and remove platen roller assembly. Push the platen roller across the slot by holding both the bar and platen roller to left side and lift up the platen roller about 2mm until the black bar has left the slot. Next, release the platen roller assembly by pulling both platen roller and black bar to the right side and the platen roller can be removed.



6. Reassemble the parts in the reverse procedures.



## 3.6 Replacing the Print head ASS'Y

1. Open the printer cover and print head release lever.



2. Release the print head assembly by using key or tools to push the hook to the right side as indicated.

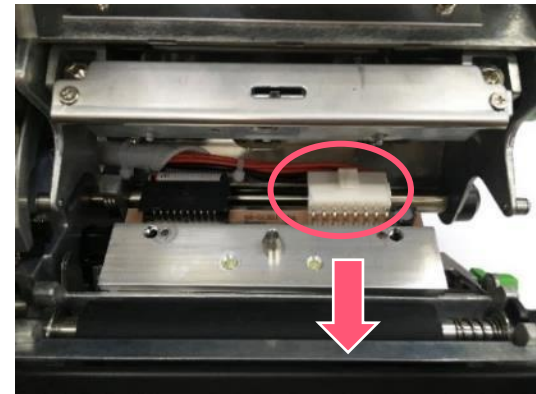
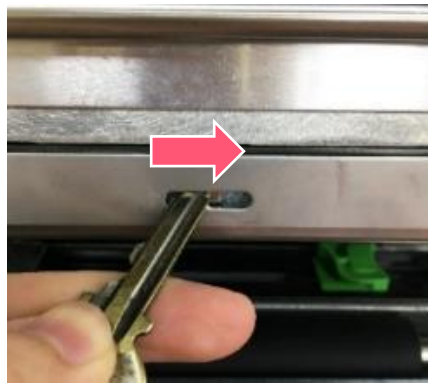
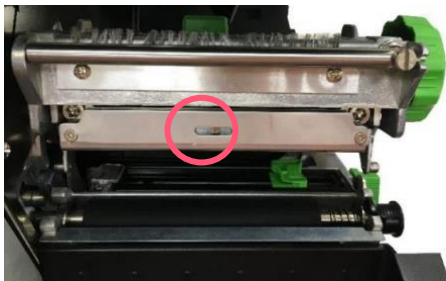

3. Carefully disconnect connectors from the print head assembly. Please do not pull the cable to right and left side alternatively in order to disconnect it from the print head connector. Please push the key in the middle of the connector.

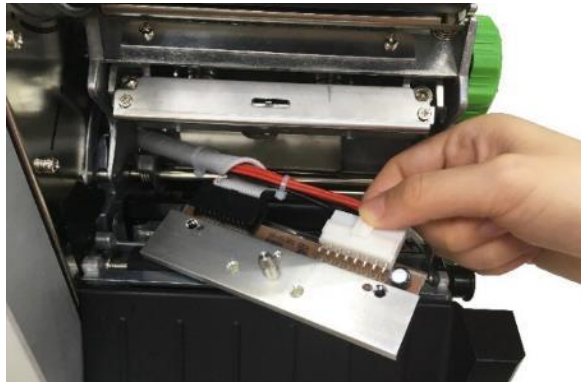

4. Remove/Replace the print head assembly.

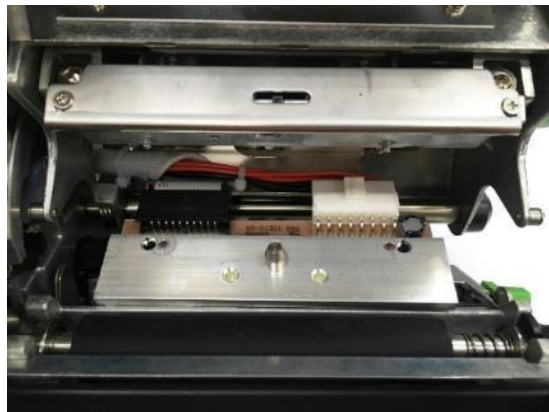

5. Reassemble the parts in the reverse procedures.

## 3.7 Replacing the LCD Panel Cover Assembly

1. Follow the previous steps (refer to section 3.2 and 3.3) to remove the electronics cover and the power supply unit.
2. Remove 2 screws (fastened by  $7.5 \text{ kg} \pm 15\% \text{ kg-cm}$ ) on left front panel cover and disconnect 2 connectors on LCD panel and USB host board.
3. Remove the cable and harness from the module.

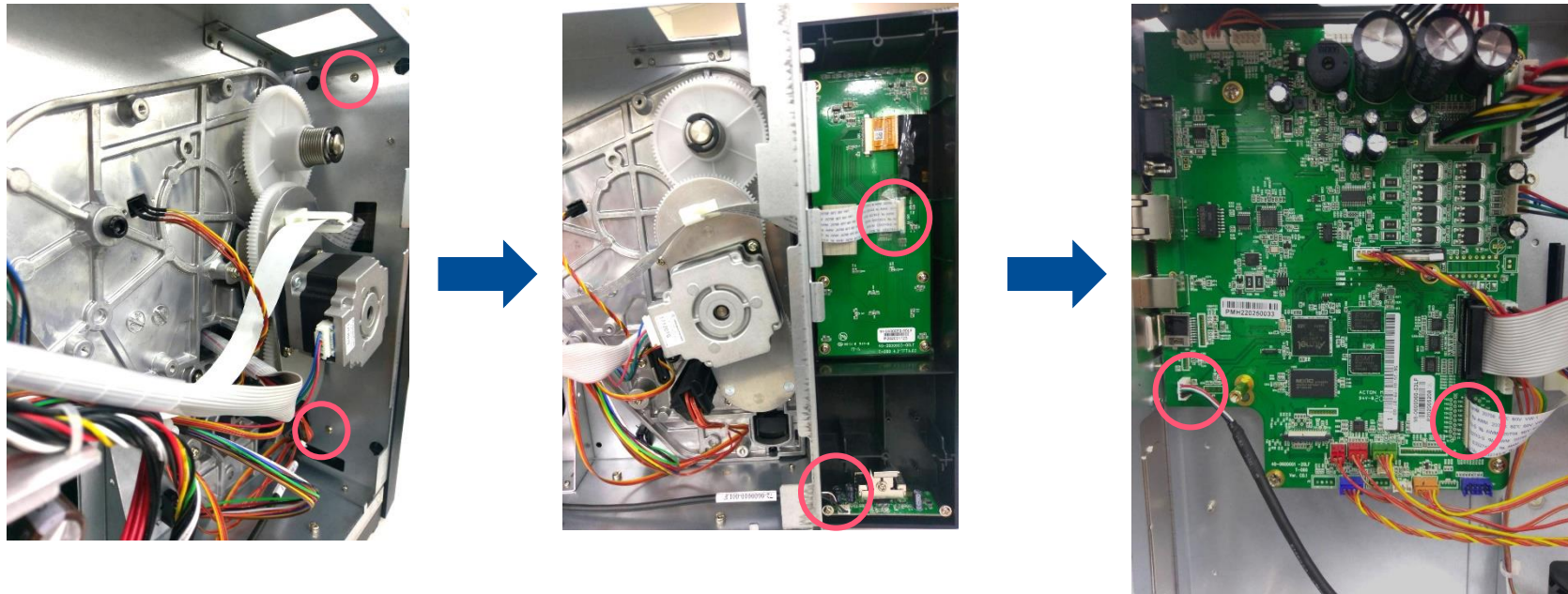

4. Reassemble the parts in the reverse procedures.

## 3.8 Replacing the LCD Control Board & LCD Touch Panel

1. Follow the previous step (refer to section 3.7) to remove the LCD panel module.
2. Remove the FPC harness from the LCD control board.

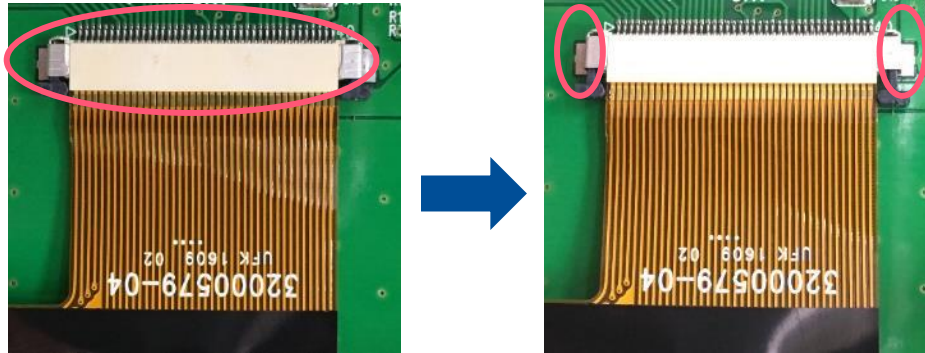

3. Remove the marked six fixed screws (fastened by  $5 \text{ kg} \pm 15\% \text{ kg-cm}$ ) to take out LCD control board, the holder and touch panel can be removed. Reassemble the parts in the reverse procedures.



Screws location



LCD control board



Touch panel

## 3.9 Replacing Front Panel Buttons Control Board

1. Refer to section 3.8 to remove the LCD Control Board & LCD Touch Panel.
2. Remove the front panel buttons control board located below the LCD Panel module.



**Front Panel Buttons Control Board**

3. Reassemble the parts in the reverse procedures.



### 3.10 Replacing the Label Supply Spindle (3" and 1")

1. Refer to section 3.2 to remove the electronic cover.
2. Uninstall the power supply unit by remove 5 screws (fastened by 7.5 kg±15% kg-cm) on the main board and interface as indicated below.

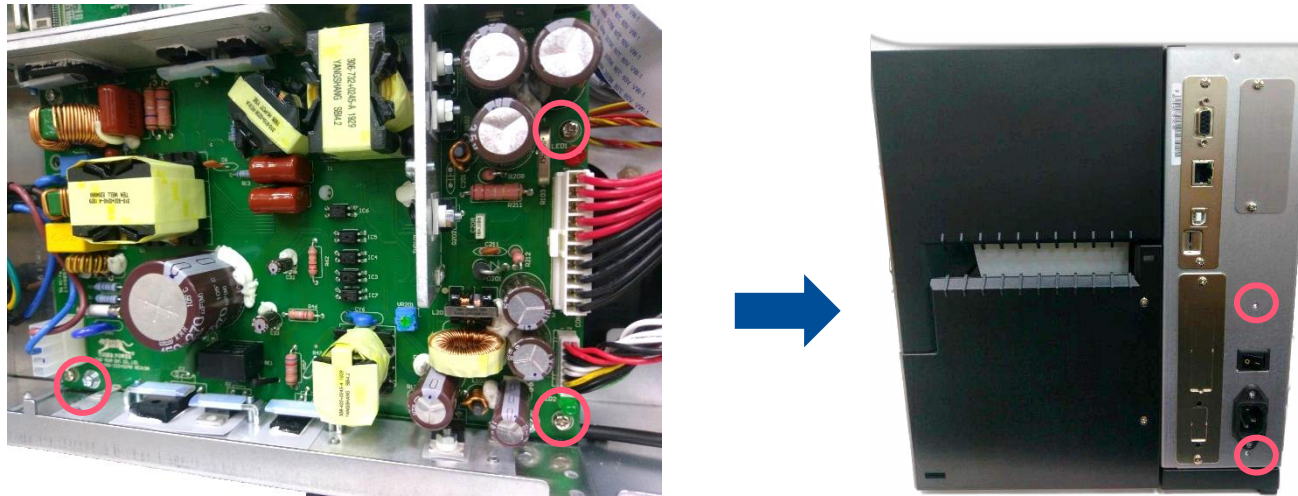

3. Remove the 7 screws (fastened by 7.5 kg±15% kg-cm), 2 hex socket cap screws (fastened by 7.5 kg±15% kg-cm), and 1 copper pillar (fastened by 7.5 kg±15% kg-cm) to uninstall the main board as indicated.

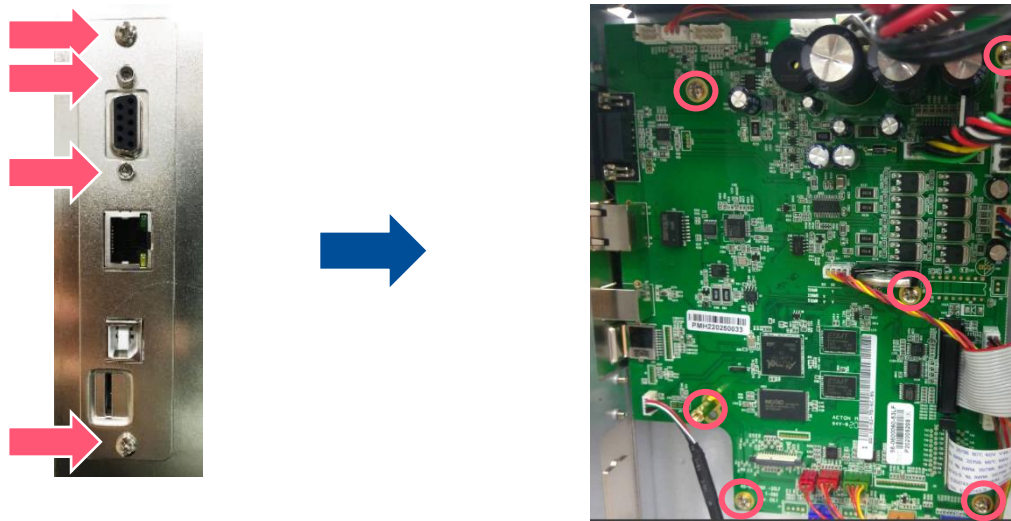

4. Remove the 2 hex socket cap screws (fastened by  $10.5 \text{ kg} \pm 15\% \text{ kg-cm}$ ) on the electronic side to release the label supply spindle assembly.



5. For 1" core label spindle, remove the screw of the spindle from the stand.
6. Remove the spindle and install the 1" core label spindel into the slot
7. Lock the screw on the side of the spindle and lock 2 screws on the back of the stand.

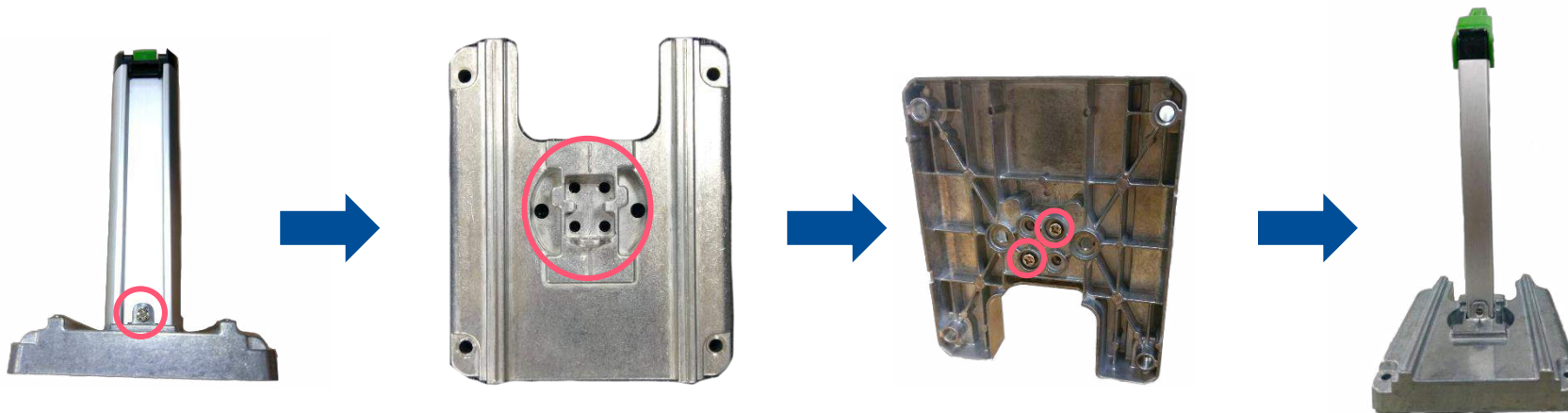

8. Reassemble the parts in the reverse procedures.

## 3.11 Replacing the Internal Rewinder DC Motor

1. Please refer to section 3.3 to remove the power supply unit and you can see the DC motor.
2. Remove the 2 marked fix screws (fastened by  $7.5 \text{ kg} \pm 15\% \text{ kg-cm}$ ) from the DC motor. Remove 2 DC motor cable connectors on the main board.

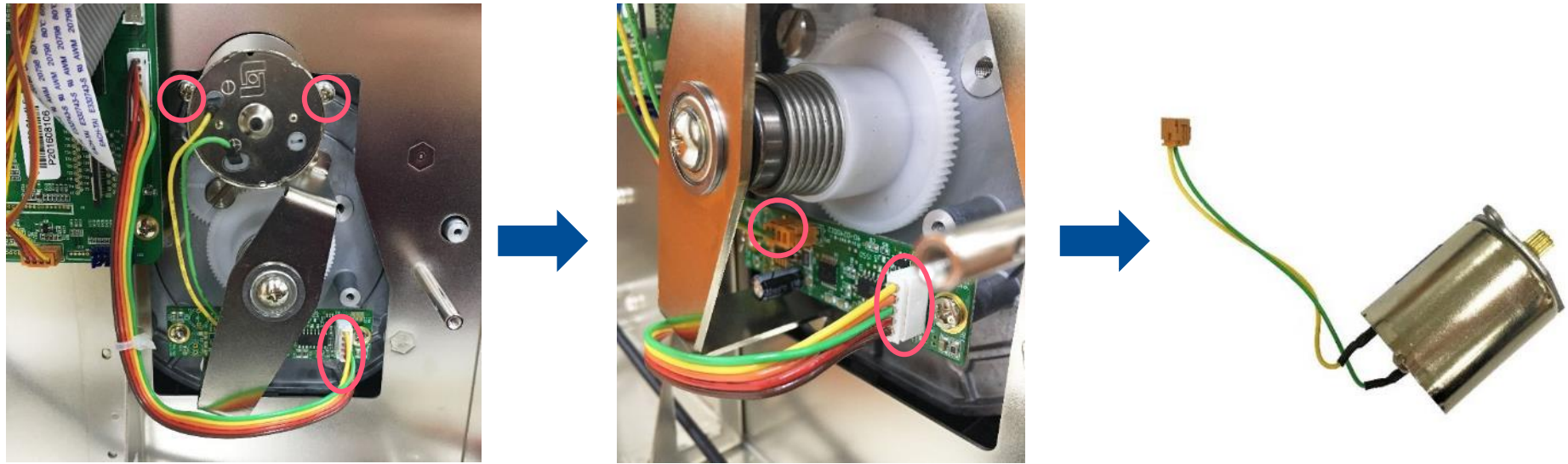

DC motor module

3. Reassemble the parts in the reverse procedures.



## 3.12 Replacing GPIO Interface Board (with Parallel Port)

1. Refer to section 3.2 to remove the electronics cover.
2. Refer to section 3.3 to remove the power supply unit.

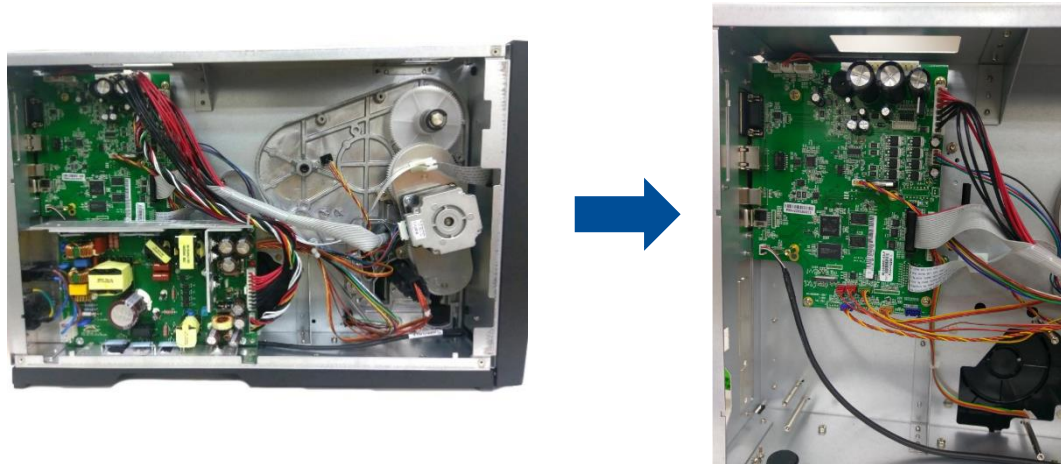

3. Remove the original GPIO interface board (screws torque:  $7.5 \text{ kg} \pm 15\% \text{ kg-cm}$ ) or protective cover as below.
4. Install the GPIO interface board from the outside of interface board.



GPIO interface board



Protective cover

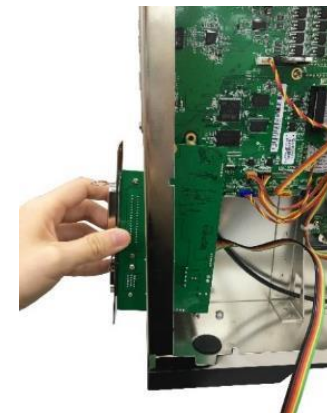

5. Fasten the cables on GPIO interface board as indicated.

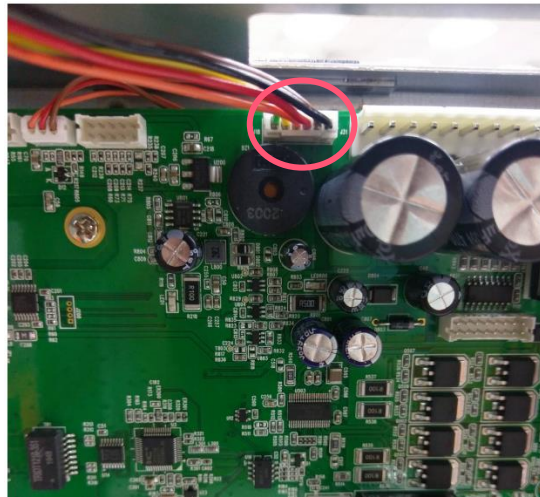
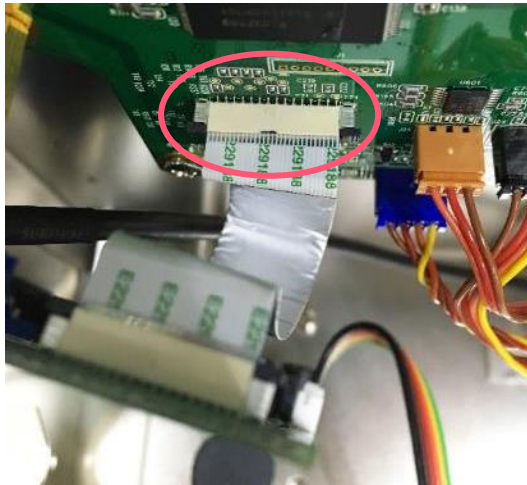

6. Fix the two screws (7.5 kg $\pm$ 15% kg-cm) on GPIO interface board as indicated.

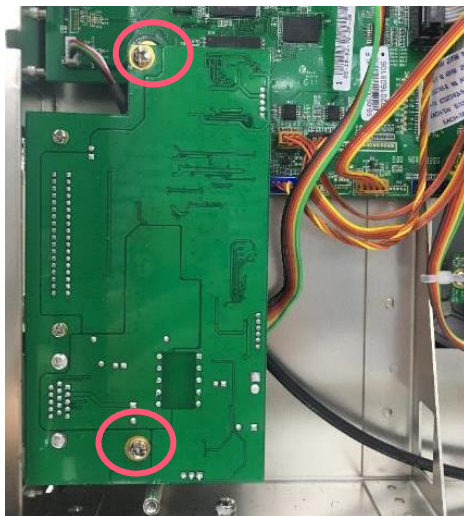

7. Remove/Replace the GPIO interface board.

8. Reassemble the parts in the reverse procedures.



### 3.13 Replacing the Main Board

1. Refer to section 3.2 to remove the electronics cover.
2. Refer to section 3.3 to remove the power supply unit.
3. Refer to section 3.12 to remove the GPIO interface board (if installed).
4. Remove the 2 screws (fastened by  $7.5 \text{ kg} \pm 15\% \text{ kg-cm}$ ) and 2 hexagon screws.
5. Remove 1 copper pillar, 5 screws (fastened by  $7.5 \text{ kg} \pm 15\% \text{ kg-cm}$ ), and all connectors from the main board.

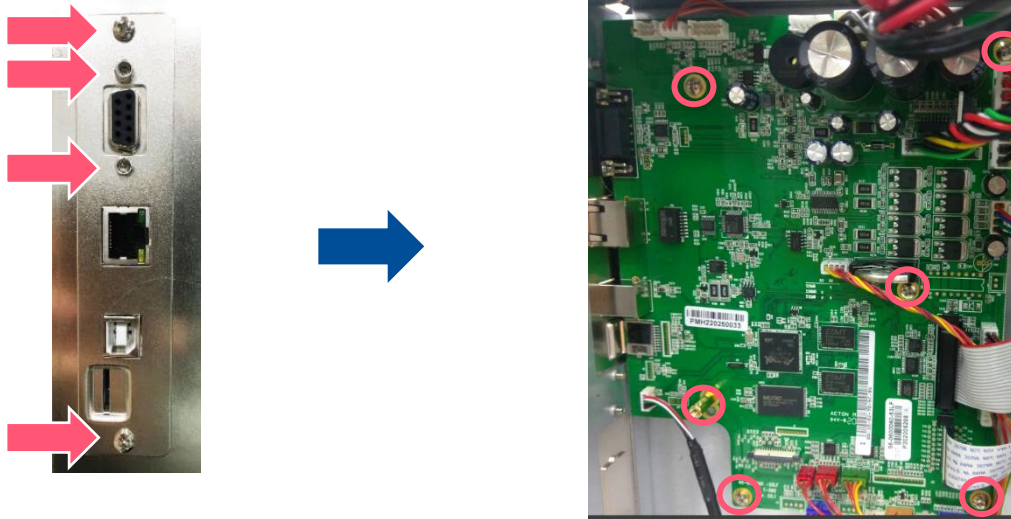

6. Remove/Replace the main board. Reassemble the parts in the reverse procedures.

## 3.14 Replacing the Stepping Motor Assembly

1. Refer to section 3.2 to remove the electronics cover.
2. Remove 4 screws (fastened by 10.5 kg±15% kg-cm) on the stepping motor assembly.
3. Unplug the cable on the motor.

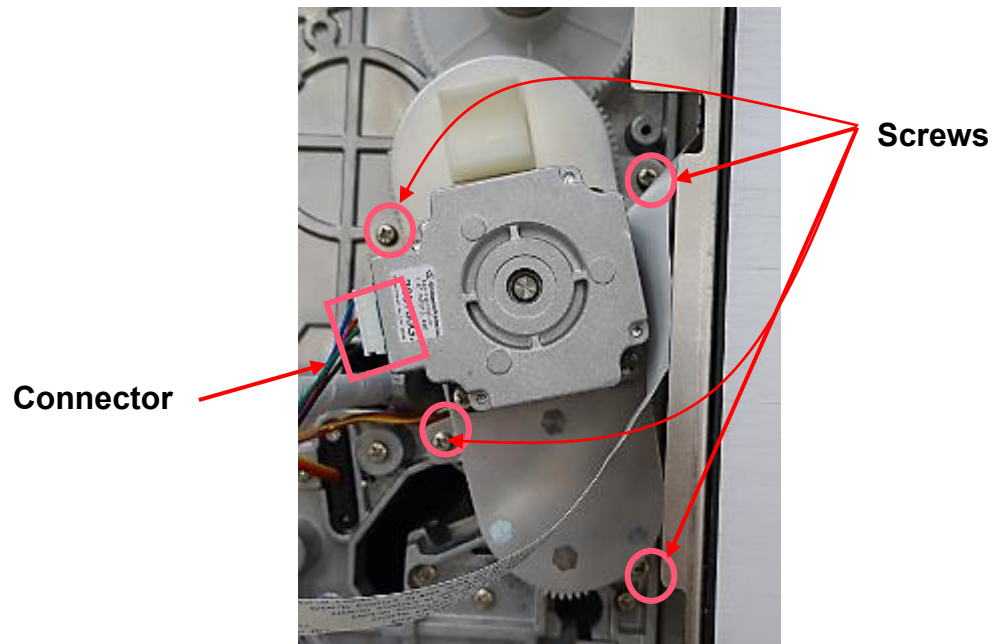

4. Remove/Replace the stepping motor assembly (including belt, gears, and stepping motor).
5. Reassemble the parts in reverse procedures.

## 3.15 Replacing the Gap/Black Mark Sensor Module

1. Refer to section 3.2 to remove the electronics cover.
2. Disconnect the gap/black mark sensor connectors from the main board.
3. Pull out the media sensor module.
4. Remove/Replace the gap/black mark sensor.

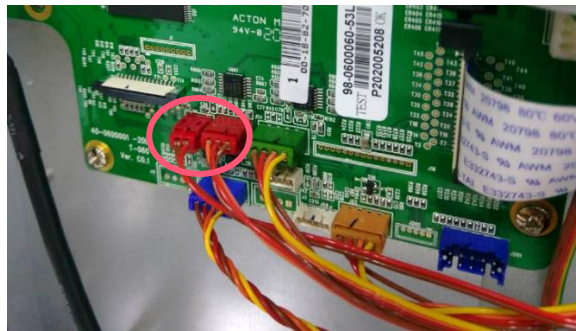

**Gap/Black mark sensor connector**

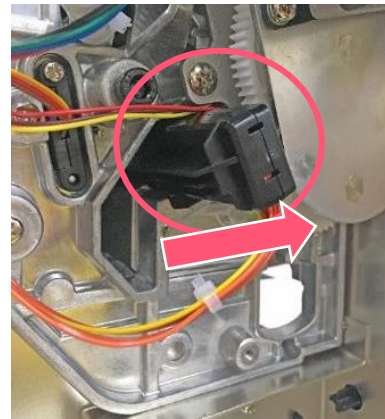

**Media sensor assembly**

5. Reassemble the parts in the reverse procedures.

## 3.16 Cutter Module Installation (Option)

1. Refer to section 3.1 to remove the lower front panel.
2. Remove the lower fixed bar by disengage the 2 screws (fastened by  $7.5 \text{ kg} \pm 15\% \text{ kg-cm}$ ).
3. Plug the cutter cable connector into the cutter/peel-off cable socket. Put 2 locating protrusions into locating holes as indicated.

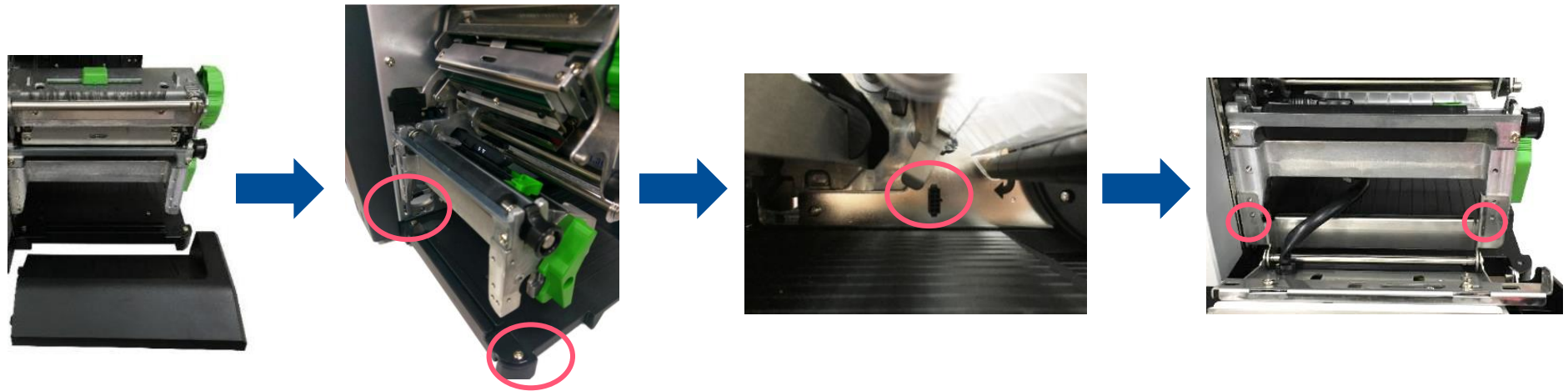

4. Fasten the 2 black fixing bolts and 2 screws ( $7.5 \text{ kg} \pm 15\% \text{ kg-cm}$ ) to fix the cutter module then closed the plate.
5. Fasten the 1 limit screw ( $7.5 \text{ kg} \pm 15\% \text{ kg-cm}$ ) and the rest 2 screws ( $7.5 \text{ kg} \pm 15\% \text{ kg-cm}$ ) on cutter module plate as indicated.

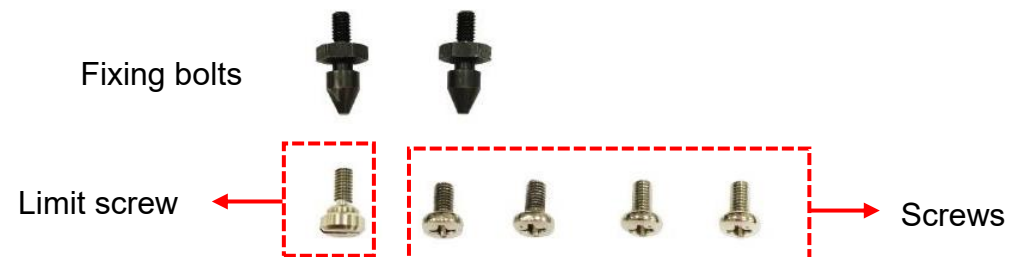

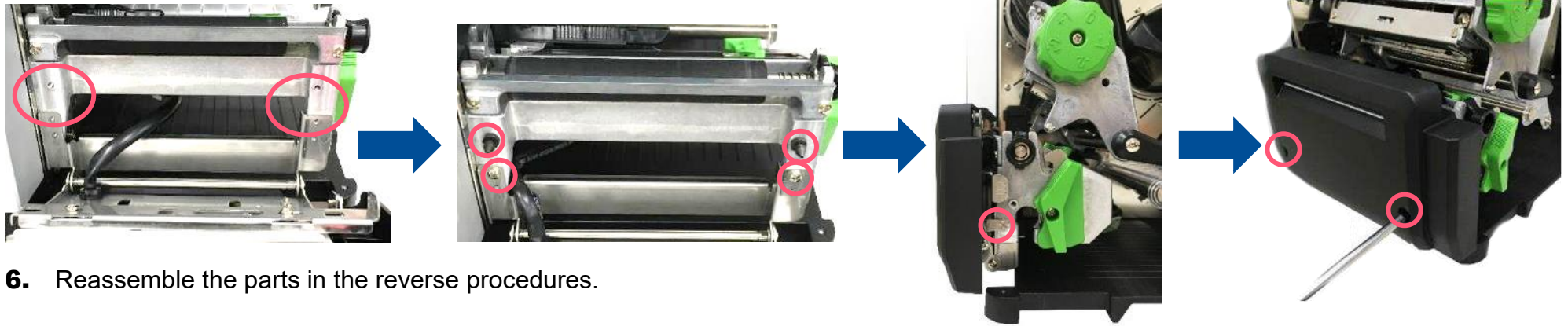

6. Reassemble the parts in the reverse procedures.



Regular guillotine cutter



Heavy duty guillotine cutter



Care Label Cutter



Rotary Cutter



### 3.17 Peel-off Kit Installation (Option)

Peel-off Kit parts list:



- 1. Peel-off roller module
- 2. Media guide bar & rear label guide module
- 3. Peel-off sensor module
- 4. Internal liner rewinder module
- 5. 2 black fixing bolts and 9 screw

### Peel-off Sensor Module Installation

1. Refer to section 3.1 to remove the lower front panel.
2. Remove the 2 screws and uninstall the lower fixed bar (fastened by  $7.5 \text{ kg} \pm 15\% \text{ kg-cm}$ ).
3. Install the peeler roller on the slot, then fix the screw ( $7.5 \text{ kg} \pm 15\% \text{ kg-cm}$ ) as indicated.

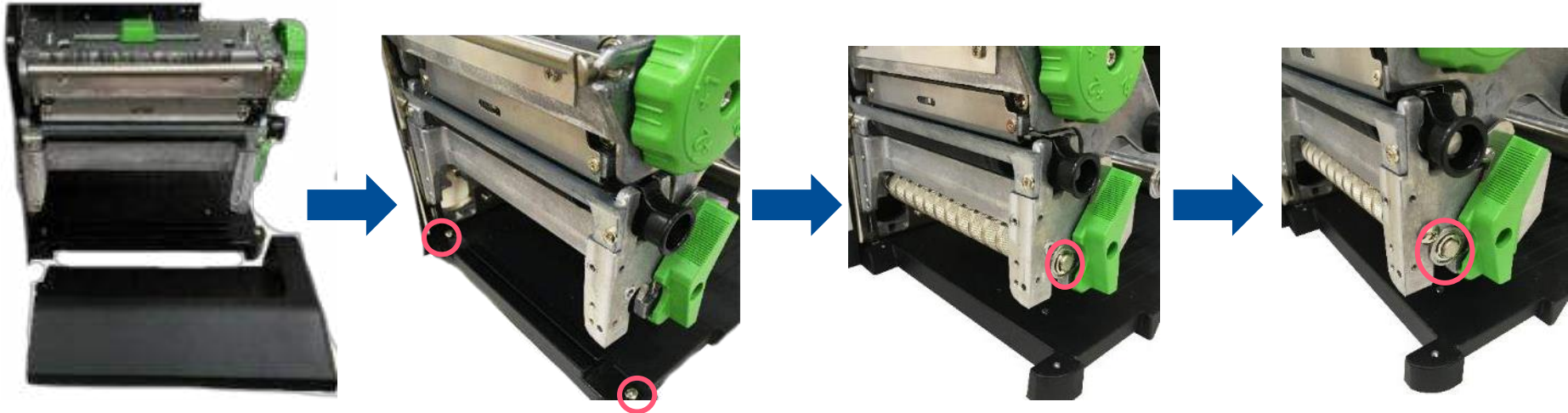

**Note:** The screw must close to the roller ring to fix it and preventing roller loosen when peeling the label.

4. Disconnect the power cord than plug the peel-off sensor module cable connector into the cutter/peel-off cable socket.



**Note:** The cable can be fixed by stick the tape on electronic side.

5. Fasten 2 set bolts (7.5 kg ±15% kg-cm) and 2 screws (7.5 kg±15% kg-cm) into the fixing holes, then close the peel-off module.
6. Fix the rest 2 screws through the reserved holes.
7. Connect the power cord and complete peel-off sensor module installation.

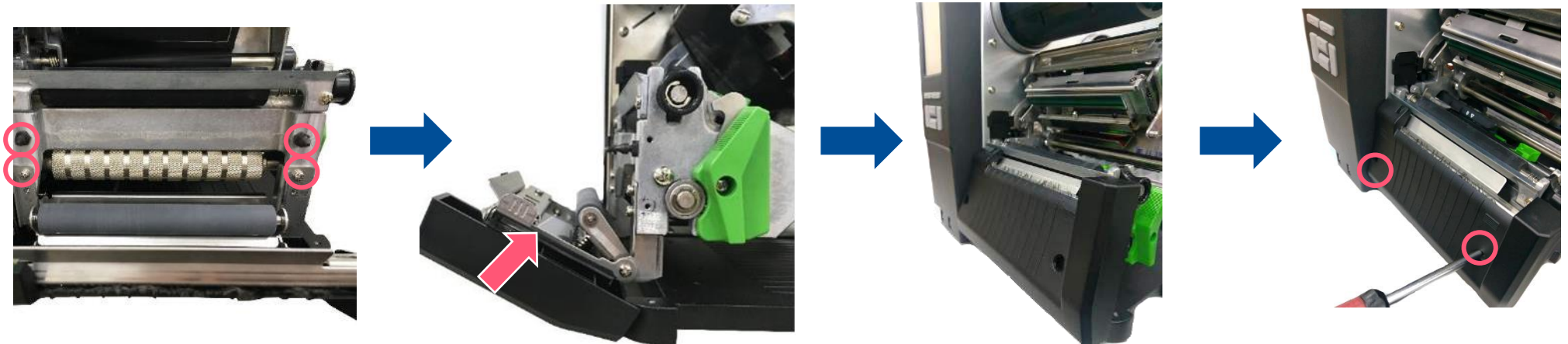

8. Remove/Replace the peel-off sensor module by the above reverse procedures.

## Rewind Spindle and Media Guide Bar Installation

1. Remove 4 screws (10.5 kg±15% kg-cm) as indicated and take out the rewind spindle cover.
2. Connect the cable to the rewinder power connector (white) as indicated.

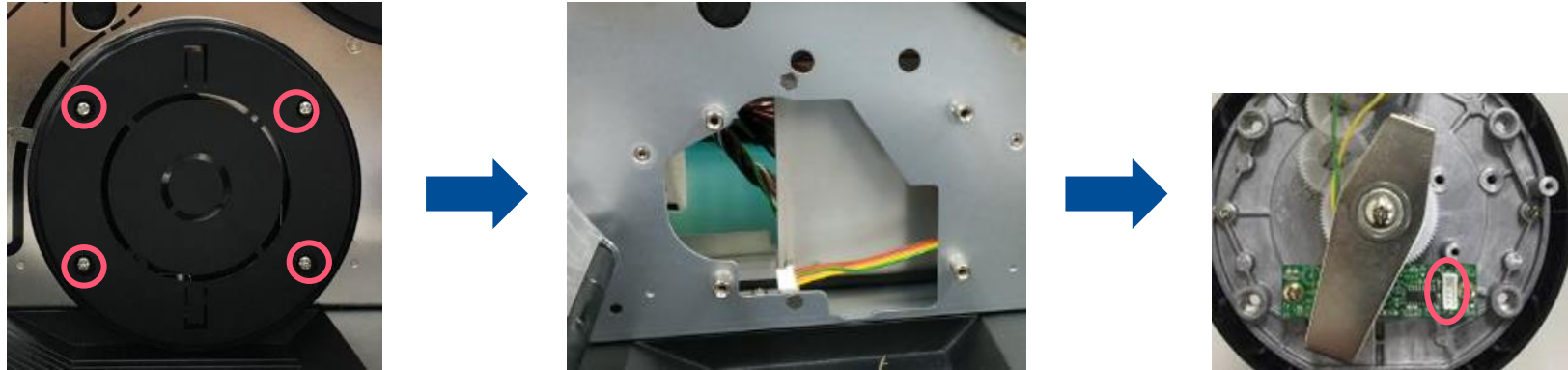

3. Using 4 screws which come with module to fix the whole rewind spindle module.

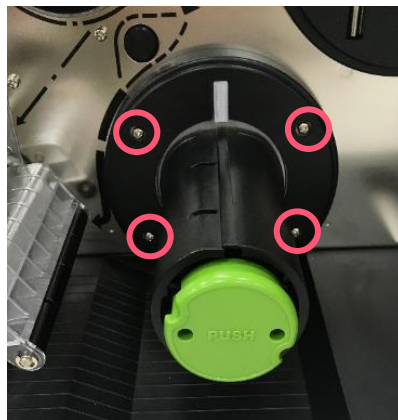

### Media Guide Bar Installation

- 1. Refer to section 3.2 to remove the electronic cover. Use the screw driver to push out the black rubber cover on the hole in electronic side as indicated.



- 2. Install the media guide bar assembly and use tool to fasten it.

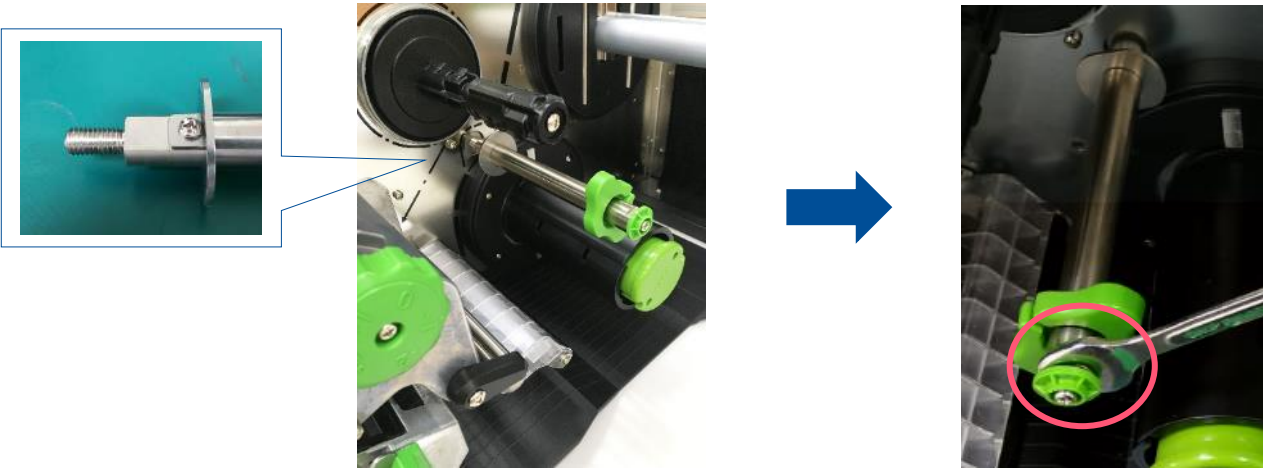

- 3. Reassemble the parts in the reverse procedures.



### 3.18 Slot-in Wireless Housing Installation (Option)

- ※ Before replacing the new Wi-Fi module, please set the default to clear the old Wi-Fi settings in the printer via TSC Console. And you need to reset the Wi-Fi settings after replacing the new Wi-Fi module.

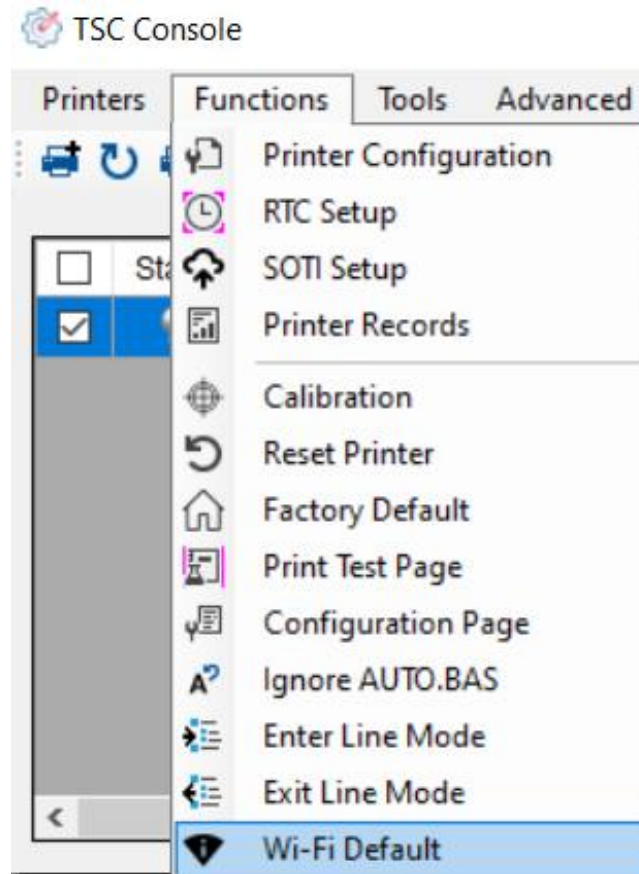

1. Refer to section 3.2 to remove the electronics cover.
2. Unscrew 2 screws to take out the housing cover.
3. Install the housing. Make cables go through the slot first, then connect to the main board.

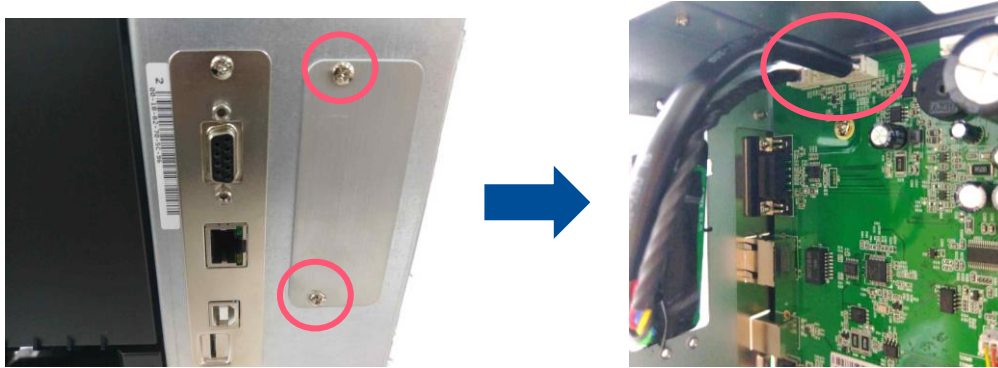

4. Push the housing in the slot and fasten 2 screws.
5. Insert the wifi module and fasten 2 screws as shown.

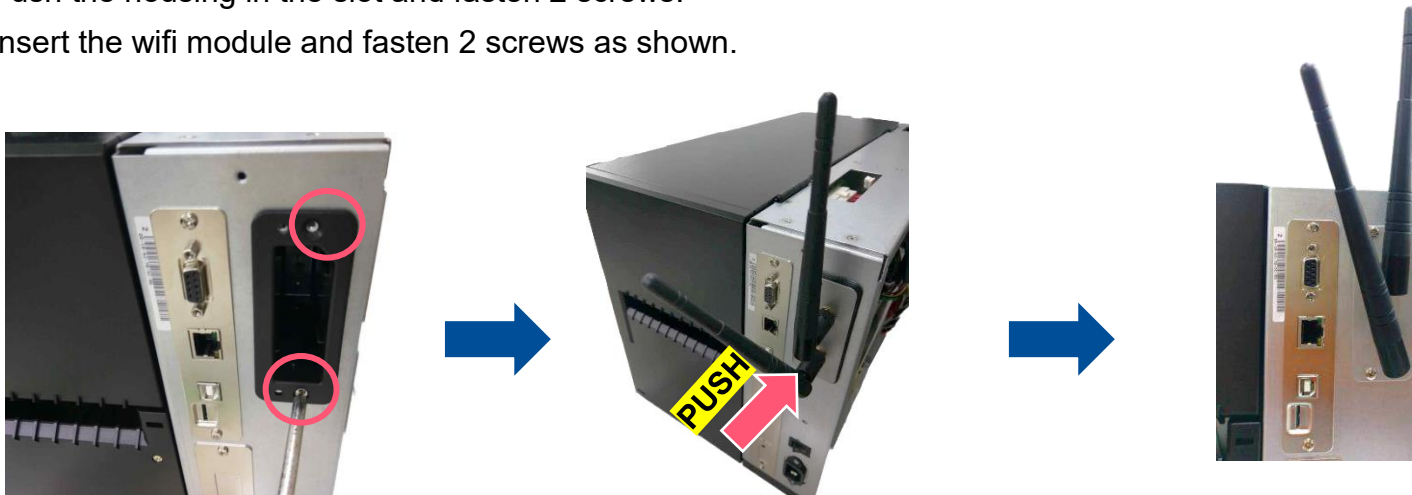

6. Remove the parts in reverse procedures.

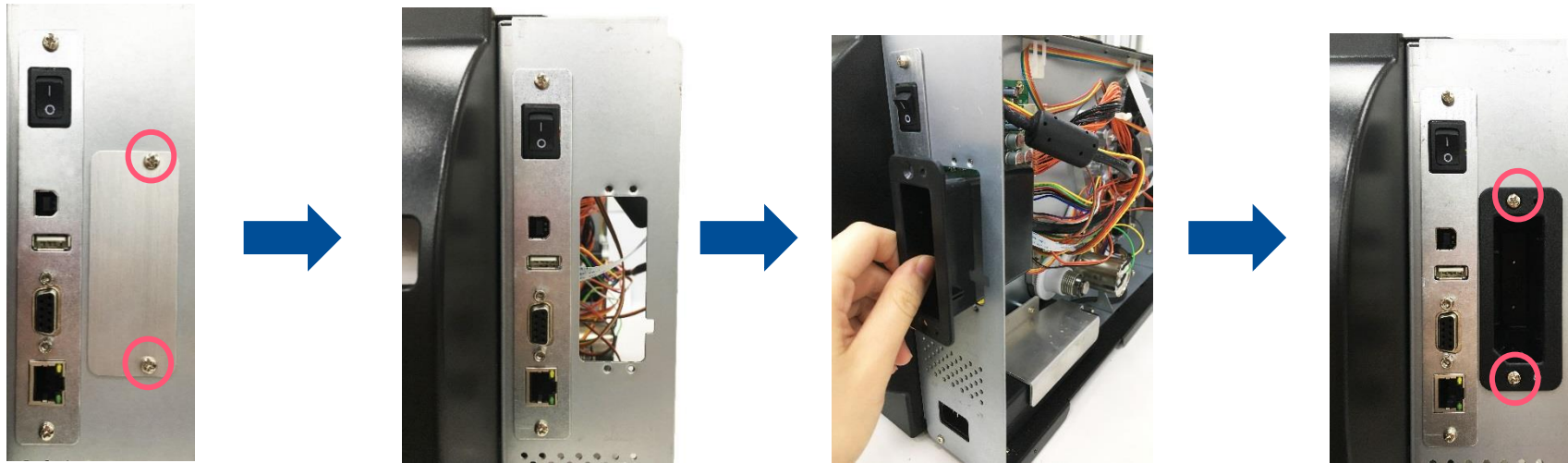

**7.** Connect the slot-in wireless transfer module housing board cable to the main board as indicated.

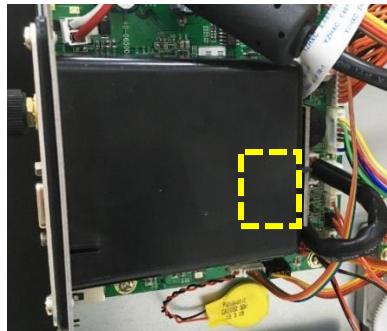

**Slot-in Wi-Fi module with antenna and transfer board**

- 8.** Remove/Replace the Slot-in Wi-Fi module.
- 9.** Reassemble the parts in the reverse procedures.

## 3.19 Replacing the Bluetooth module

1. Refer to section 3.2 to remove the electronics cover.
2. Refer to section 3.3 to remove the power supply unit.



3. Refer to section 3.12 to remove the GPIO interface board (if installed).
4. Plug the Bluetooth module cable to the connector as indicated.
5. Please load the Bluetooth cable through the path as indicated.

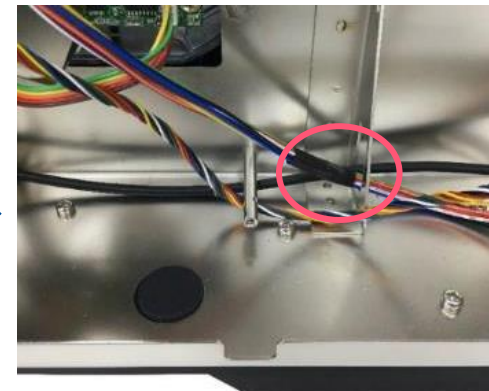

6. Remove the two screws (fastened by  $7.5 \text{ kg} \pm 15\% \text{ kg-cm}$ ) on the left front panel cover and install the Bluetooth module to the lower panel as indicated.

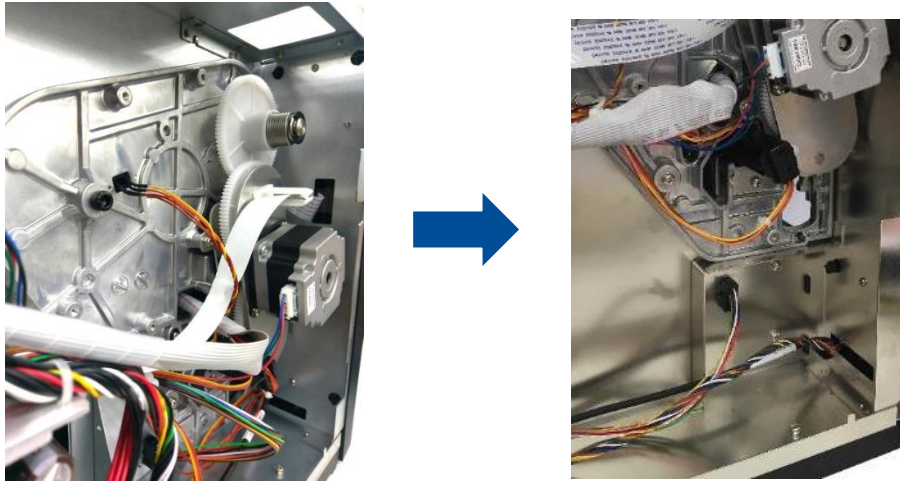

7. Connect the Bluetooth and Bluetooth cable and then fix it to the front panel ( $3 \text{ kg} \pm 15\% \text{ kg-cm}$ ) as below.
8. Fix the left front panel cover and complete the installation of Bluetooth module.



9. Reassemble the parts in the reverse procedures.



## 3.20 Care Label Cutter Module Installation (Option)

1. Refer to section 3.1 to remove the lower front panel.
2. Please replace the tear bar used with care label cutter module by remove the 2 screws as indicated.



3. Remove the lower fixed bar by disengage the 2 screws (fastened by  $7.5 \text{ kg} \pm 15\% \text{ kg-cm}$ ).
4. Plug the cable connector of care label cutter into the cutter/peel-off cable socket. Put 2 locating protrusions into locating holes as indicated.



5. Fasten the 2 black fixing bolts and 2 screws (7.5 kg±15% kg-cm) to fix the cutter module then closed the plate.
6. Fasten the 1 limit screw (7.5 kg±15% kg-cm) and the rest 2 screws (7.5 kg±15% kg-cm) on cutter module plate as indicated.

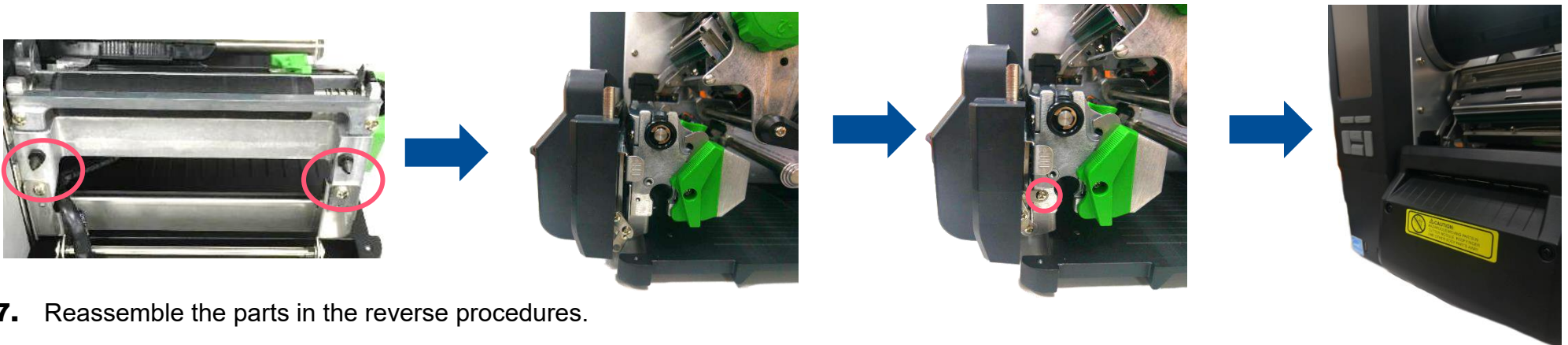

7. Reassemble the parts in the reverse procedures.



Care Label Cutter

# 3.21 Internal Rewinder Module Installation (Option, MH241/MH241T Series Only)

Overview:

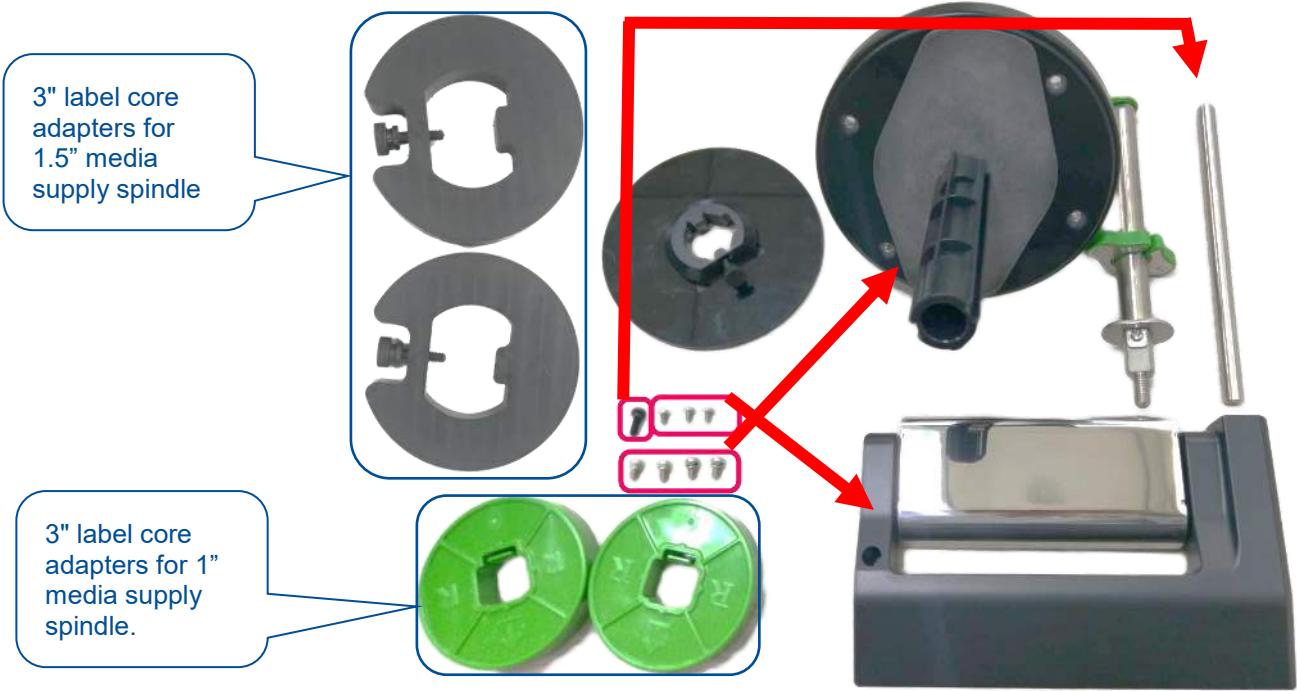

1. Refer 3.2 to remove electronic cover.
2. Refer 3.3 to remove power supply unit.

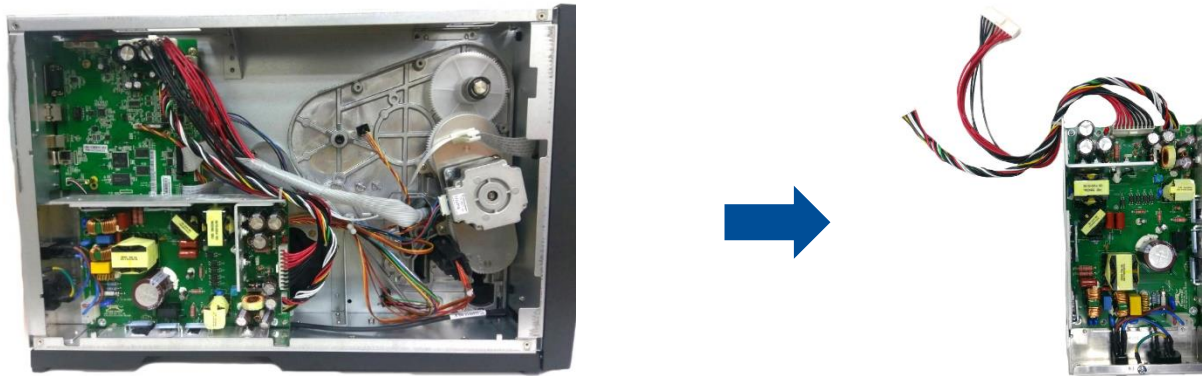

3. Unscrew 4 marked screws.
4. Install the media rewind spindle and screw the marked 4 screws.
5. Connect the cable to the motor's board.

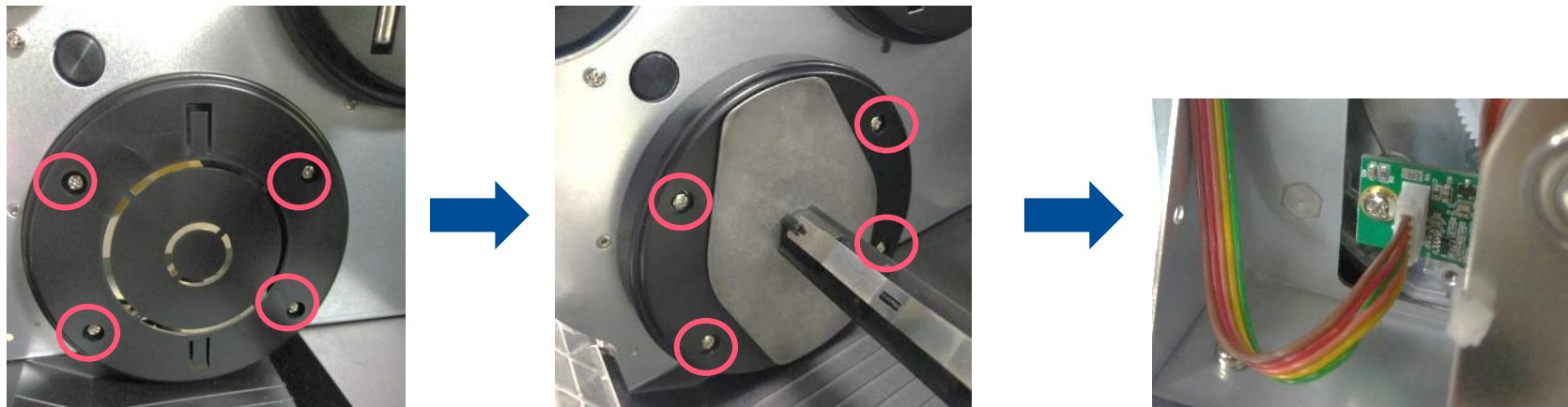



6. Put the power supply unit back.
7. Take off the lid on the marked position.
8. Take off the lid on the marked position.

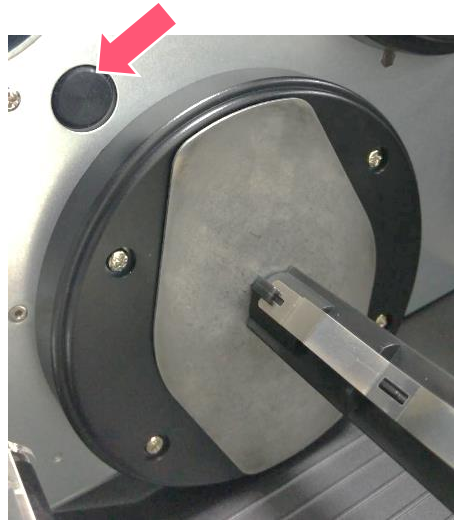
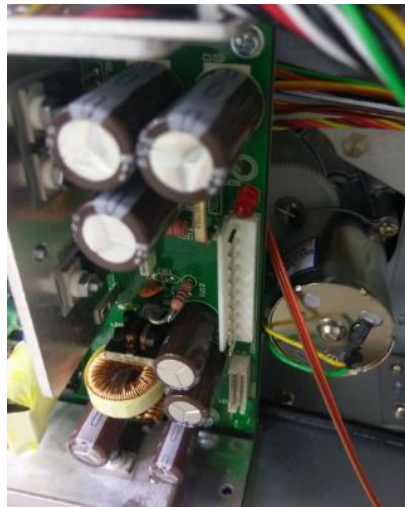

9. Install and tighten up the upper media guide bar.





**10.** Install the lower media guide's screw in marked potion.

**11.** Combine the lower media guide bar and the screw.

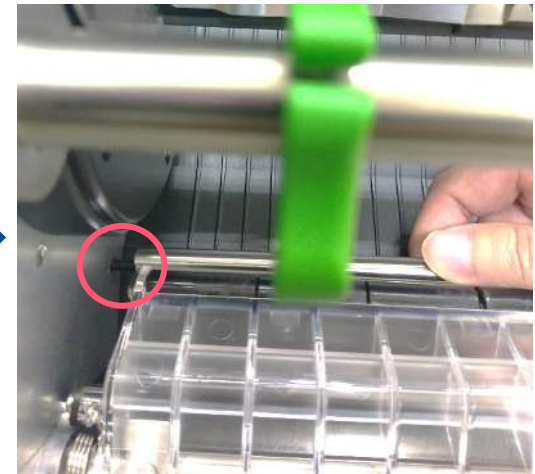
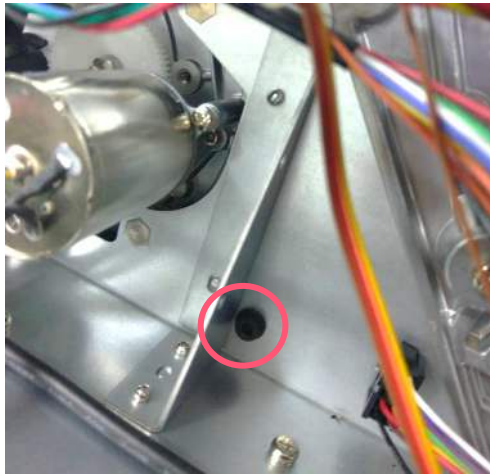

**12.** Refer 3.1 to remove lower front cover.

**13.** Install the front cover for rewinder module.

**14.** Screw the marked 3 screws.

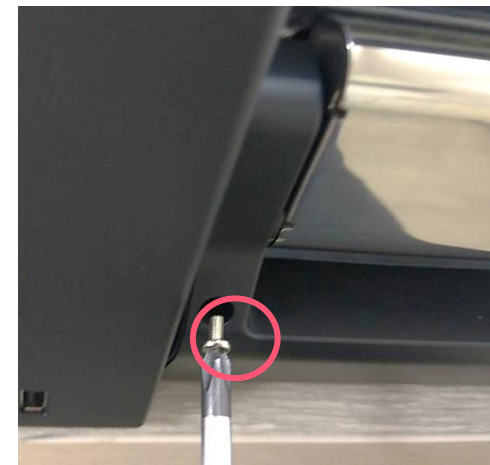
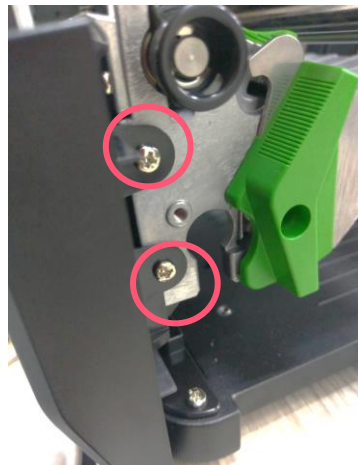

**15.** Remove the parts in reverse procedures.

**Note:**

- ♦ If you are using 3" paper core labels, attach the 3" label core adapters to the media supply spindle when using internal rewinder.

**For 1.5" media supply spindle**

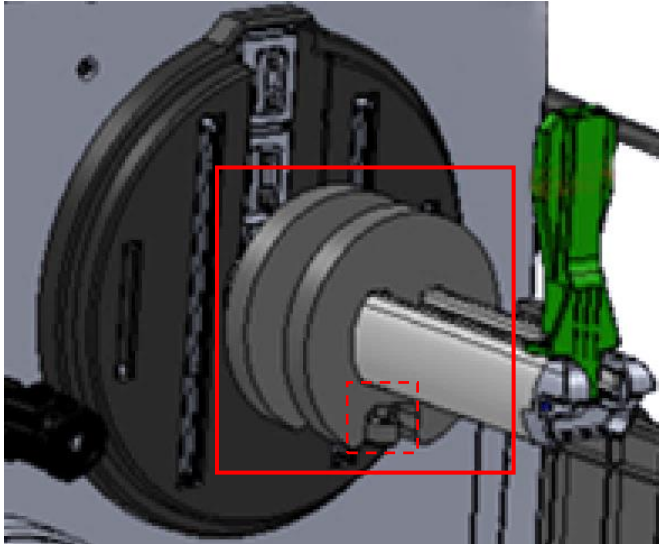

**Loosen the screw and install on the spindle.**

**For 1" media supply spindle**

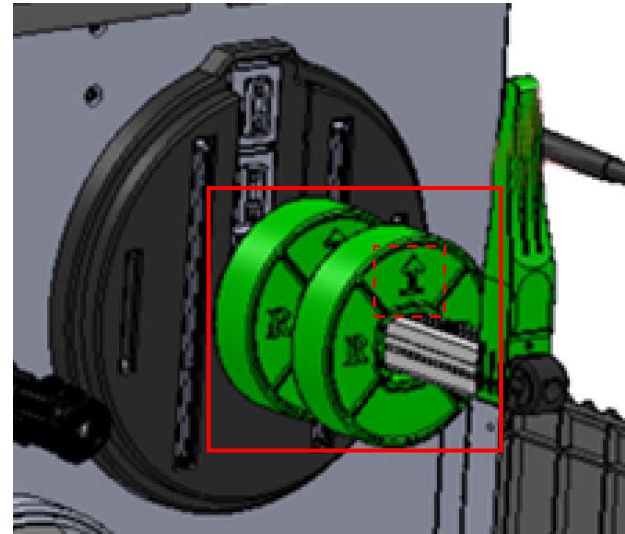

**Arrow pointing up and install on the spindle.**

**Label roll guard for internal rewinder spindle**

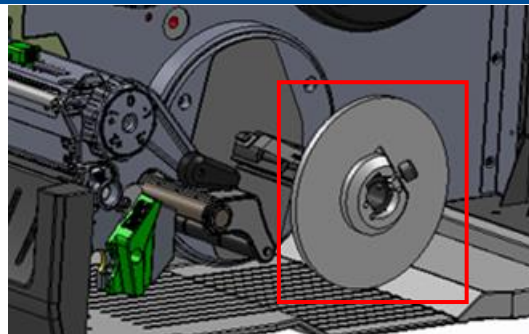

## 4. Troubleshooting

Problem	Possible Cause	Recovery Procedure
<b>Power indicator does not illuminate</b>	<ul style="list-style-type: none"> <li>■ The power cord is not properly connected.</li> <li>■ The power switch is closed.</li> </ul>	<ul style="list-style-type: none"> <li>■ Plug the power cord in printer and outlet.</li> <li>■ Switch the printer on.</li> </ul>
<b>Carriage Open</b>	<ul style="list-style-type: none"> <li>■ The printer carriage is open.</li> </ul>	<ul style="list-style-type: none"> <li>■ Close the print carriage.</li> </ul>
<b>Not Printing</b>	<ul style="list-style-type: none"> <li>■ Check if interface cable is well connected.</li> <li>■ Check if wireless or Bluetooth device is well connected.</li> <li>■ The port in the Windows driver is not correct.</li> </ul>	<ul style="list-style-type: none"> <li>■ Re-connect cable to interface or change a new cable.</li> <li>■ Reset the wireless device setting.</li> <li>■ Select the correct printer port in the driver.</li> <li>■ Clean the printhead.</li> <li>■ Printhead's harness connector is not well connected with printhead. Turn off the printer and plug the connector again.</li> <li>■ Check your program if there is a command - PRINT at the end of the file and there must have CRLF at the end of each command line.</li> </ul>
<b>No print on the label</b>	<ul style="list-style-type: none"> <li>■ Label or ribbon is loaded not correctly.</li> <li>■ Use wrong type paper or ribbon</li> </ul>	<ul style="list-style-type: none"> <li>■ Follow the instructions in loading the media and ribbon.</li> <li>■ Ribbon and media are not compatible.</li> <li>■ Verify the ribbon-inked side.</li> <li>■ The print density setting is incorrect.</li> </ul>
<b>No Ribbon</b>	<ul style="list-style-type: none"> <li>■ Running out of ribbon.</li> <li>■ The ribbon is installed incorrectly.</li> </ul>	<ul style="list-style-type: none"> <li>■ Supply a new ribbon roll.</li> <li>■ Refer to user's manual to reinstall the ribbon.</li> </ul>
<b>No Paper</b>	<ul style="list-style-type: none"> <li>■ Running out of label.</li> <li>■ The label is installed incorrectly.</li> <li>■ Gap/black mark sensor is not calibrated.</li> </ul>	<ul style="list-style-type: none"> <li>■ Supply a new label roll.</li> <li>■ Refer to user's manual to reinstall the label roll.</li> <li>■ Calibrate the gap/black mark sensor.</li> </ul>
<b>Paper Jam</b>	<ul style="list-style-type: none"> <li>■ Gap/black mark sensor is not set properly.</li> <li>■ Make sure label size is set properly.</li> <li>■ Labels may be stuck inside the printer mechanism.</li> </ul>	<ul style="list-style-type: none"> <li>■ Calibrate the media sensor.</li> <li>■ Set media size correctly.</li> <li>■ Remove the stuck label inside the printer mechanism.</li> </ul>
<b>Take Label</b>	<ul style="list-style-type: none"> <li>■ Peel function is enabled.</li> </ul>	<ul style="list-style-type: none"> <li>■ If peeler module is installed, please remove the label.</li> <li>■ If there is no peeler module in front of the printer, please switch off the printer and install it.</li> <li>■ Check if the connector is plugging correctly.</li> </ul>
<b>Can't downloading the file to memory (FLASH / DRAM/CARD)</b>	<ul style="list-style-type: none"> <li>■ The space of memory is full.</li> </ul>	<ul style="list-style-type: none"> <li>■ Delete unused files in the memory.</li> </ul>

<b>Poor Print Quality</b>	<ul style="list-style-type: none"> <li>■ Ribbon and media is loaded incorrectly.</li> <li>■ Dust or adhesive accumulation on the print head.</li> <li>■ Print density is not set properly.</li> <li>■ Printhead element is damaged.</li> <li>■ Ribbon and media are incompatible.</li> <li>■ The printhead pressure is not set properly.</li> </ul>	<ul style="list-style-type: none"> <li>■ Reload the supply.</li> <li>■ Clean the print head.</li> <li>■ Clean the platen roller.</li> <li>■ Adjust the print density and print speed.</li> <li>■ Run printer self-test and check the print head test pattern if there is dot missing in the pattern.</li> <li>■ Change proper ribbon or proper label media.</li> <li>■ Adjust the printhead pressure adjustment knob.</li> <li>■ The release lever does not latch the printhead properly.</li> </ul>
<b>Missing printing on the left or right side of label</b>	<ul style="list-style-type: none"> <li>■ Wrong label size setup.</li> </ul>	<ul style="list-style-type: none"> <li>■ Set the correct label size.</li> </ul>
<b>Gray line on the blank label</b>	<ul style="list-style-type: none"> <li>■ The print head is dirty.</li> <li>■ The platen roller is dirty.</li> </ul>	<ul style="list-style-type: none"> <li>■ Clean the print head.</li> <li>■ Clean the platen roller.</li> <li>■ (Please refer to chapter 8)</li> </ul>
<b>Irregular printing</b>	<ul style="list-style-type: none"> <li>■ The printer is in Hex Dump mode.</li> <li>■ The RS-232 setting is incorrect.</li> </ul>	<ul style="list-style-type: none"> <li>■ Turn off and on the printer to skip the dump mode.</li> <li>■ Re-set the RS-232 setting.</li> </ul>
<b>Label feeding is not stable (skew) when printing</b>	<ul style="list-style-type: none"> <li>■ The media guide does not touch the edge of the media.</li> </ul>	<ul style="list-style-type: none"> <li>■ If the label is moving to the right side, please move the label guide to left.</li> <li>■ If the label is moving to the left side, please move the label guide to right.</li> </ul>
<b>Skip labels when printing</b>	<ul style="list-style-type: none"> <li>■ Label size is not specified properly.</li> <li>■ Sensor sensitivity is not set properly.</li> <li>■ The media sensor is covered with dust.</li> </ul>	<ul style="list-style-type: none"> <li>■ Check if label size is setup correctly.</li> <li>■ Calibrate the sensor by Auto Gap or Manual Gap options.</li> <li>■ Clear the GAP/Black mark sensor by blower.</li> </ul>
<b>Wrinkle Problem</b>	<ul style="list-style-type: none"> <li>■ Printhead pressure is incorrect.</li> <li>■ Ribbon installation is incorrect.</li> <li>■ Media installation is incorrect.</li> <li>■ Print density is incorrect.</li> <li>■ Media feeding is incorrect.</li> </ul>	<ul style="list-style-type: none"> <li>■ Please refer to the chapter 4.</li> <li>■ Please set the suitable density to have good print quality.</li> <li>■ Make sure the label guide touch the edge of the media guide.</li> </ul>
<b>RTC time is incorrect when reboot the printer</b>	<ul style="list-style-type: none"> <li>■ The battery has run down.</li> </ul>	<ul style="list-style-type: none"> <li>■ Check if there is a battery on the main board.</li> </ul>
<b>The left side printout position is incorrect</b>	<ul style="list-style-type: none"> <li>■ Wrong label size setup.</li> <li>■ The parameter Shift X in LCD menu is incorrect.</li> </ul>	<ul style="list-style-type: none"> <li>■ Set the correct label size.</li> <li>■ Press [Menu] → [Setting] → [Shift X] to fine tune the parameter of Shift X.</li> </ul>
<b>The printing position of small label is incorrect</b>	<ul style="list-style-type: none"> <li>■ Media sensor sensitivity is not set properly.</li> <li>■ Label size is incorrect.</li> <li>■ The parameter Shift Y in the LCD menu is incorrect.</li> <li>■ The vertical offset setting in the driver is incorrect.</li> </ul>	<ul style="list-style-type: none"> <li>■ Calibrate the sensor sensitivity again.</li> <li>■ Set the correct label size and gap size.</li> <li>■ Press [Menu] → [Setting] → [Shift Y] → to fine tune the parameter of Shift Y.</li> <li>■ Set the vertical offset in the driver if you're using BarTender.</li> </ul>
<b>LCD panel is dark and keys are not working</b>	<ul style="list-style-type: none"> <li>■ The cable between main PCB and LCD panel is loose.</li> </ul>	<ul style="list-style-type: none"> <li>■ Check if the cable between main PCB and LCD is secured or not.</li> </ul>

<b>LCD panel is dark but the LEDs are light</b>	<ul style="list-style-type: none"> <li>■ The printer initialization is unsuccessful.</li> </ul>	<ul style="list-style-type: none"> <li>■ Turn OFF and ON the printer again.</li> <li>■ Initialize the printer.</li> </ul>
<b>Ribbon encoder sensor doesn't work</b>	<ul style="list-style-type: none"> <li>■ The ribbon encoder sensor connector is loose.</li> </ul>	<ul style="list-style-type: none"> <li>■ Fasten the connector.</li> </ul>
<b>Ribbon end sensor doesn't work</b>	<ul style="list-style-type: none"> <li>■ The connector is loose.</li> <li>■ The ribbon sensor hole is covered with dust.</li> </ul>	<ul style="list-style-type: none"> <li>■ Check the connector.</li> <li>■ Clear the dust in the sensor hole by the blower.</li> </ul>
<b>Cutter is not working</b>	<ul style="list-style-type: none"> <li>■ The connector is loose.</li> </ul>	<ul style="list-style-type: none"> <li>■ Plug in the connect cable correctly.</li> </ul>



## 4.1 Knob Adjustment

**Printhead Pressure Adjustment Knob** has 5 levels' adjustment. Different number means different pressure to the springs . Due to media is aligned to the inbound of the printer mechanism, different media width requires the different pressure. Users can try which level can meet their expectation.

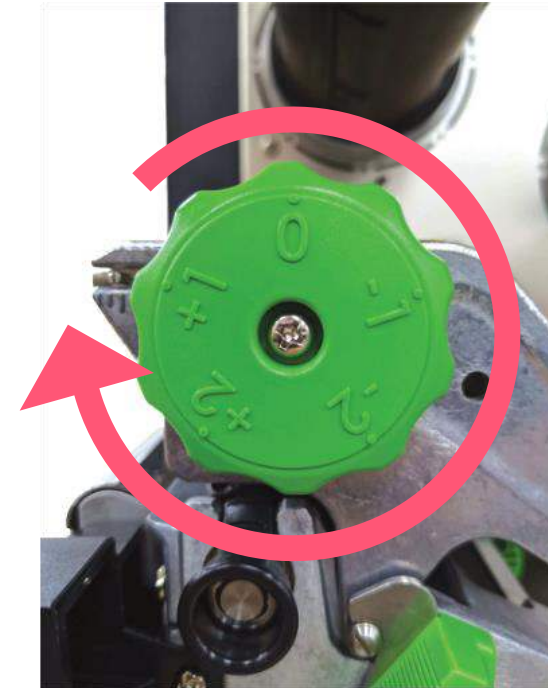
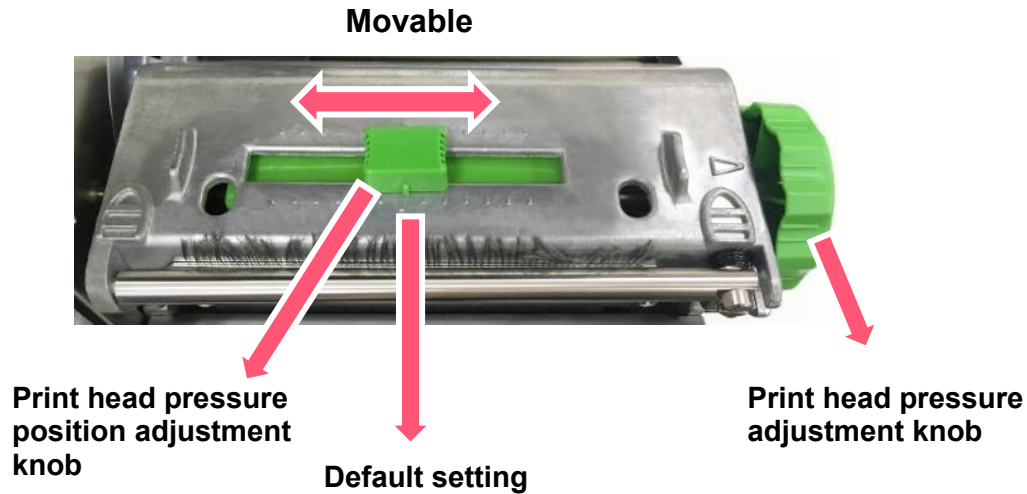

Note:

For the media width less than 2 inches, please fix the **Print head pressure position knob** inside the edge of the label as possible (prevent the unnecessary friction between the print head and platen roller).

## 4.2 Ribbon Tension Adjustment Knob

**Ribbon Tension Adjustment Knob** has 5 positions for adjustment. Due to the ribbon is aligned to the inbound of print mechanism, different width of ribbons may need to adjust the tension adjustment knob to avoid the ribbon wrinkle and get the best print quality.

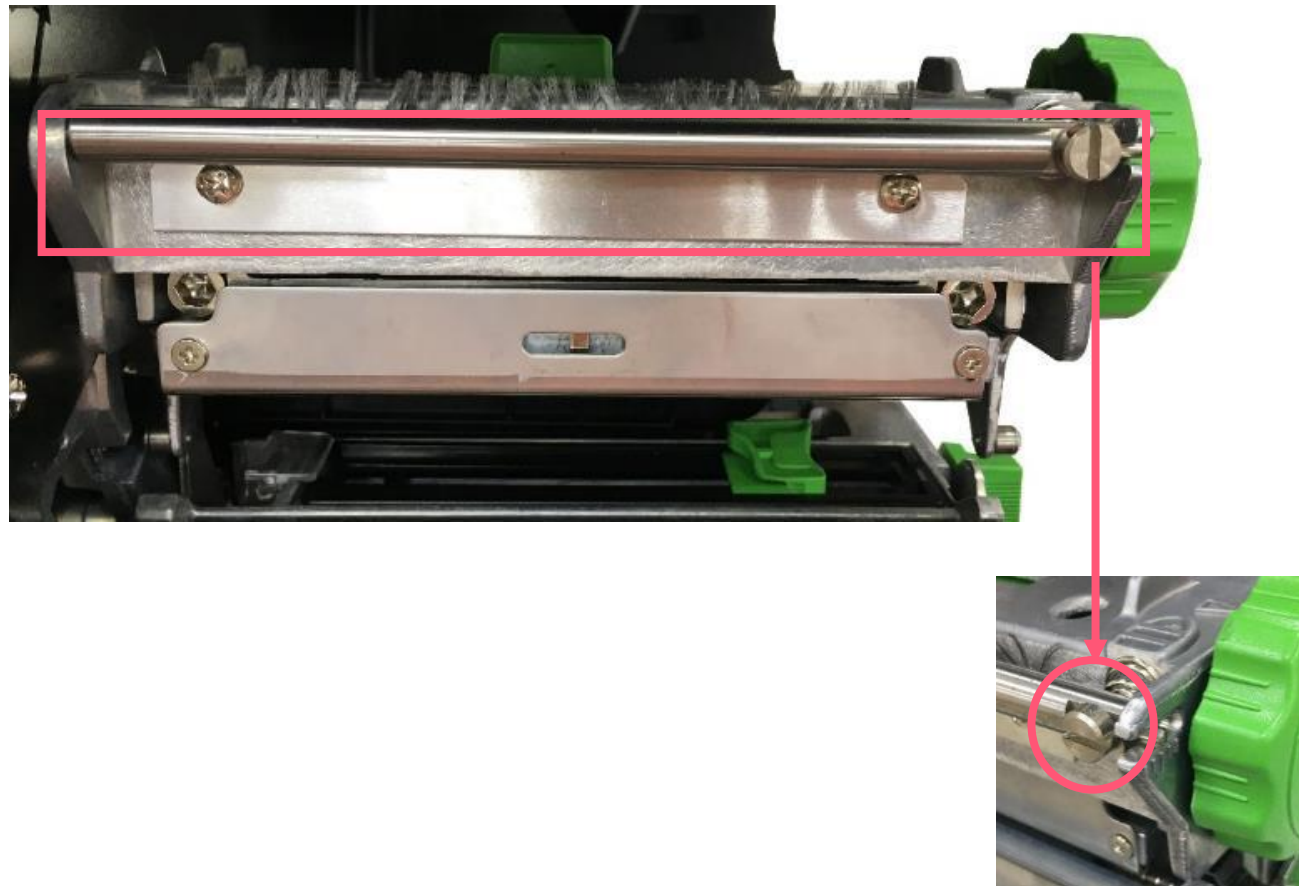

## 4.3 Mechanism Fine Adjustment to Avoid Ribbon Wrinkles

**Ribbon wrinkle** is related to the media width, thickness, print head pressure balance, ribbon film characteristics, print darkness setting...etc. In case the ribbon wrinkle happens, please follow the instructions below to adjust the printer parts.

Ribbon Tension Adjustment Knob has 5 positions for adjustment. Use screw driver to change the ribbon tension position.

**Wrinkle happens from label lower right to upper left direction**

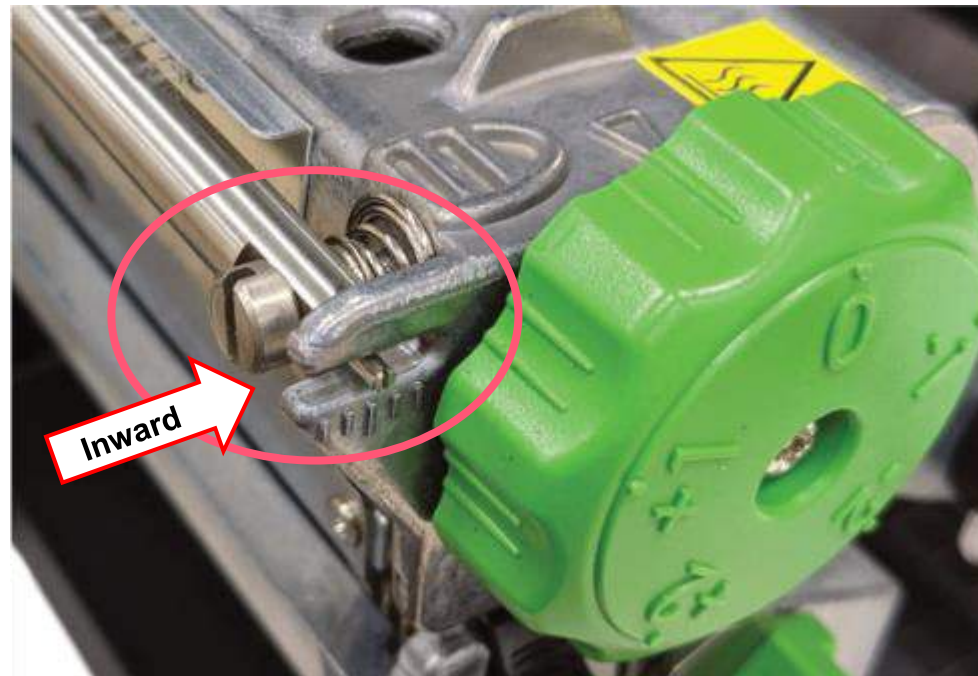

- Make sure the **Print Head Pressure Adjustment Knob** is in correct position for the current media. Ex: 1~2", 3~4"
- Turn the screw clockwise per level and print to see if the wrinkle has gone.
- If the ribbon tension adjustment knob has positioned on the level of innermost side but doesn't improve the ribbon wrinkle, please switch the print head pressure at 1 level and print the label again to check if the wrinkle is gone.
- If the wrinkle can't be avoided, please contact the Customer Service Department of your purchased reseller or distributor for service.

### Wrinkle happens from label lower left to upper right direction



- Make sure the Print head Pressure Adjustment Knob is in correct position for the current media. Ex: 1~2", 3~4"
- Turn the screw counterclockwise per level and print to see if the wrinkle has gone.
- If the ribbon tension adjustment knob has positioned on the level of outermost side but doesn't improve the ribbon wrinkle, please switch the print head pressure at 1 level and print the label again to check if the wrinkle is gone.
- If the wrinkle can't be avoided, please contact the Customer Service Department of your purchased reseller or distributor for service.



# 5. Maintenance

This session presents the clean tools and methods to maintain the printer.

## ■ For Cleaning

Depending on the media used, the printer may accumulate residues (media dust, adhesives, etc.) as a by-product of normal printing. To maintain the best printing quality, you should remove these residues by cleaning the printer periodically. Regularly clean the print head and supply sensors once change a new media to keep the printer at the optimized performance and extend printer life.

## ■ For Disinfecting

Sanitize your printer to protect yourself and others and can help prevent the spread of viruses.

## ■ Important

- Set the printer power switch to O (Off) prior to performing any cleaning or disinfecting tasks. Leave the power cord connected to keep the printer grounded and to reduce the risk of electrostatic damage.
- Do not wear rings or other metallic objects while cleaning any interior area of the printer.
- Use only the cleaning agents recommended in this document. Use of other agents may damage the printer and void its warranty.
- Do not spray or drip liquid cleaning solutions directly into the printer. Apply the solution on a clean lint-free cloth and then apply the dampened cloth to the printer.
- Do not use canned air in the interior of the printer as it can blow dust and debris onto sensors and other critical components.
- Only use a vacuum cleaner with a nozzle and hose that are conductive and grounded to drain off static build up.
- All reference in these procedures for use of isopropyl alcohol requires that a 99% or greater isopropyl alcohol content be used to reduce the risk of moisture corrosion to the printhead.
- Do not touch printhead by hand. If you touch it carelessly, please use 99% Isopropyl alcohol to clean it.
- Always taking personal precaution when using any cleaning agent.

## Cleaning Tools

- Cotton swab
- Lint-free cloth
- Brush with soft non-metallic bristles
- Vacuum cleaner
- 75% Ethanol (for disinfecting)
- 99% Isopropyl alcohol (for printhead and platen roller cleaning)
- Genuine printhead cleaning pen
- Mild detergent (without chlorine)

## Cleaning Process:

Printer Part	Method	Interval
<b>Print Head</b>	<ol style="list-style-type: none"> <li>I. Always turn off the printer before cleaning the printhead.</li> <li>II. Allow the printhead to cool for at least one minute.</li> <li>III. Use a cotton swab and 99% Isopropyl Alcohol or genuine print head cleaning pen to clean the print head surface.</li> </ol>	Clean the print head when changing a new label roll.
<b>Platen Roller</b>	<ol style="list-style-type: none"> <li>I. Turn off the printer.</li> <li>II. Rotate the platen roller and wipe it thoroughly with the lint-free 99% Isopropyl Alcohol.</li> </ol>	Clean the platen roller when changing a new label roll
<b>Peel Bar</b>	Use the lint-free cloth with 99% Isopropyl Alcohol to wipe it.	As needed
<b>Sensor</b>	Use brush with soft non-metallic bristles or a vacuum cleaner, to remove paper dust. Clean upper and lower media sensors to ensure reliable Top of Form and Paper Out sensing.	Monthly
<b>Exterior</b>	Clean the exterior surfaces with a clean, lint-free cloth (water-dampened cloth). If necessary, use a mild detergent or desktop cleaning solution then use the 75% Ethanol to wipe it.	As needed
<b>Interior</b>	Clean the interior of the printer by removing any dirt and lint with a vacuum cleaner, as described above, or use a brush with soft non-metallic bristles then use the 75% Ethanol to wipe it.	As needed

# Revision History

Date	Content	Editor
2024/7/23	Updated ch.3.15 (Replacing the Gap/Black Mark Sensor Module) Updated ch 3.21 (Internal Rewinder Module Installation)	Camille



[www.tscprinters.com](http://www.tscprinters.com)