

# TE200 Series

Thermal Transfer / Direct Thermal  
Desktop Barcode Printers



Series Lists:

TE200 / TE300

TE210 / TE310

## Service Manual

# Copyright Information

©2021 TSC Auto ID Technology Co., Ltd.

The copyright in this manual, the software and firmware in the printer described are owned by TSC Auto ID Technology Co., Ltd. All rights reserved.

CG Triumvirate is a trademark of Agfa Corporation. CG Triumvirate Bold Condensed font is under license from the Monotype Corporation. Windows is a registered trademark of Microsoft Corporation.

All other trademarks are the property of their respective owners. Information in this document is subject to change without notice and does not represent a commitment on the part of TSC Auto ID Technology Co. No part of this manual may be reproduced or transmitted in any form or by any means, for any purpose other than the purchaser's personal use, without the expressed written permission of TSC Auto ID Technology Co.



## Table of Content

1. Fundamental of the System.....	1
1.1 Printer Overview .....	1
Front View .....	1
Interior View .....	2
Rear View .....	3
2. Electronics.....	4
2.1 Summary of the Board Connectors .....	4
3. Mechanism.....	13
3.1 Replacing the Platen Roller.....	13
3.2 Replacing the Main Board.....	16
3.3 Replacing the Stepping Motor .....	17
3.4 Replacing the Gap Sensor Module .....	19
3.5 Replacing the Black Mark Sensor Module.....	21
3.6 Replacing the Platen Roller Assembly .....	22
3.7 Replacing the Stepping Motor .....	23
3.8 Installing the Cutter Module (TE210/TE310 Series Option) .....	25
3.9 Installing the Peeler Module (TE210/TE310 Series Option) .....	27
3.10 Replacing the Key Module (LCE MODULE / Option).....	29
3.11 Replacing the Print Head Open Sensor Assembly .....	30
3.12 Replacing the Encoder Assembly .....	31

3.13 Replacing the Label Guide Module .....	33
3.14 Replacing Wi-Fi module Assembly (TE210/TE310 Series option) .....	37
4. TroubleShooting .....	38
5. Maintenance.....	41
Revise History .....	43



# 1. Fundamental of the System

## 1.1 Printer Overview

### Front View



1. Paper exit chute
2. LED indicator
3. Feed/Pause button
4. Top cover open tab

## Interior View



1. Printer top cover
2. Ribbon supply spindle
3. Ribbon supply hub
4. Ribbon rewind hub
5. Ribbon rewind spindle
6. Fixing tabs
7. Media supply spindle
8. Print head release button
9. Print head
10. Media guide adjustment knob
11. Media guide
12. Platen roller
13. Gap sensor
14. Black mark sensor

## Rear View

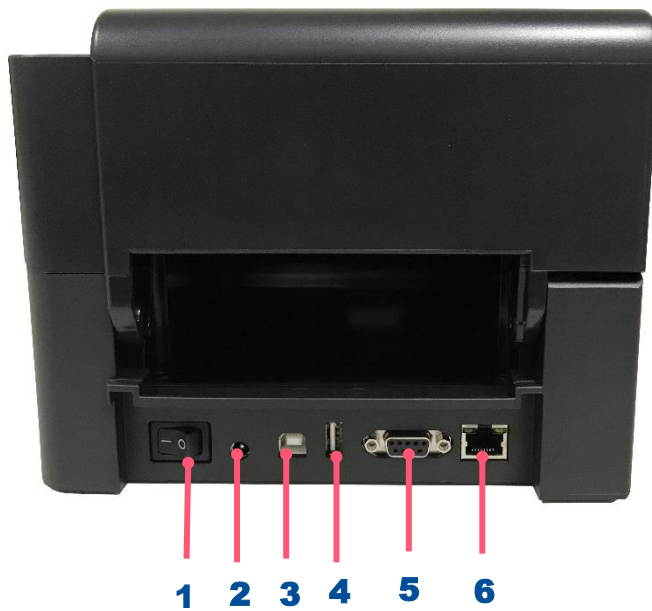

1. Power switch
2. Power jack socket
3. USB interface (USB 2.0/Hi-Speed mode)
4. USB host (TE210/TE310 Series only)
5. RS-232 interface (TE210/TE310 Series only)
6. Ethernet interface (TE210/TE310 Series only)

## 2. Electronics

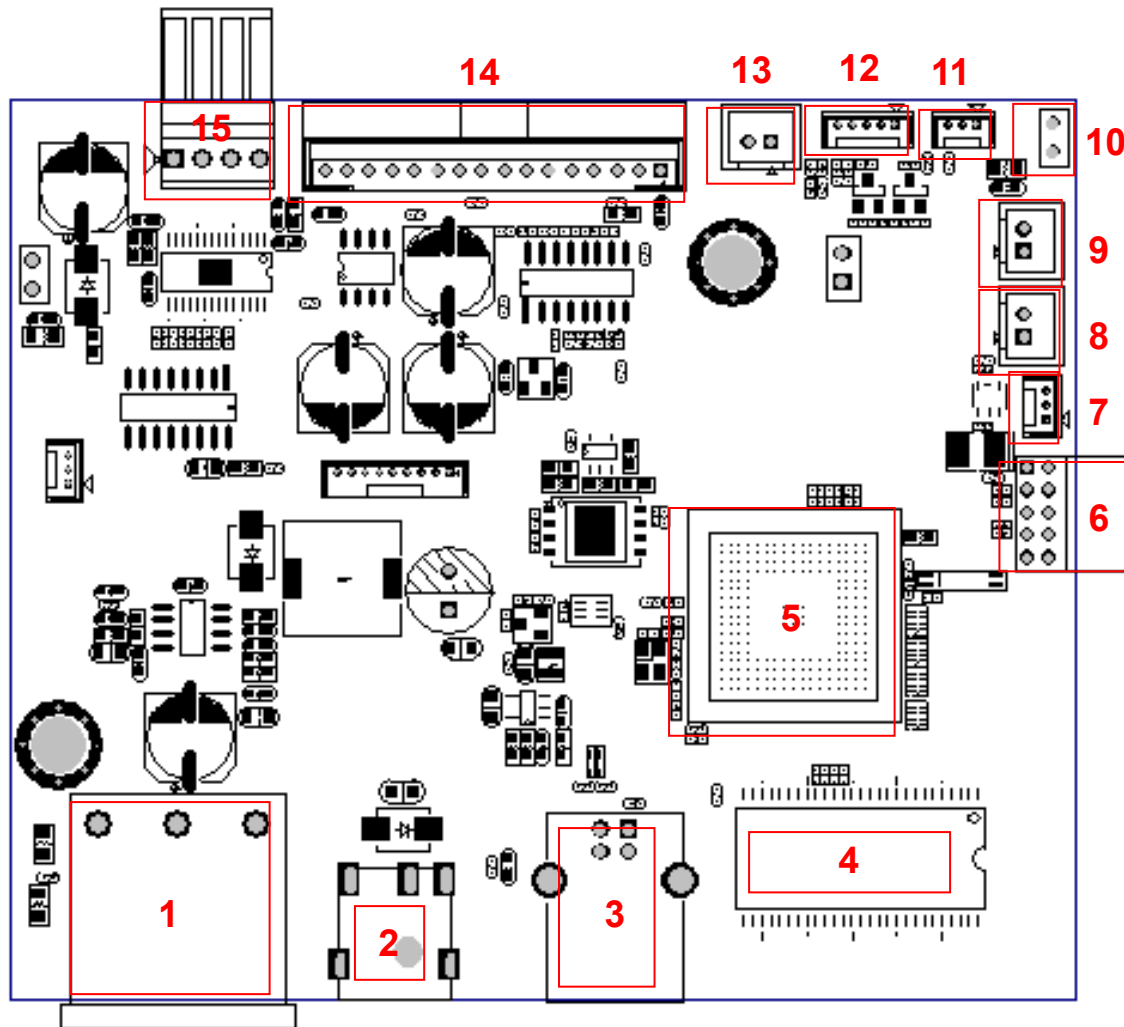

### 2.1 Summary of the Board Connectors

Main board top



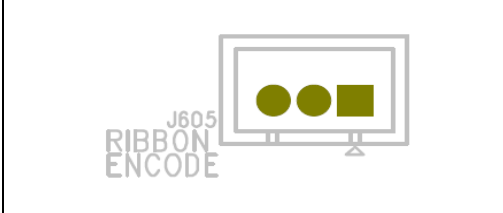
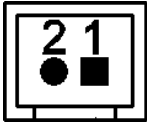
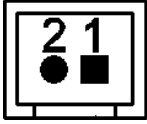
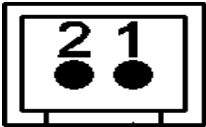

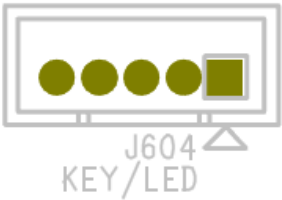

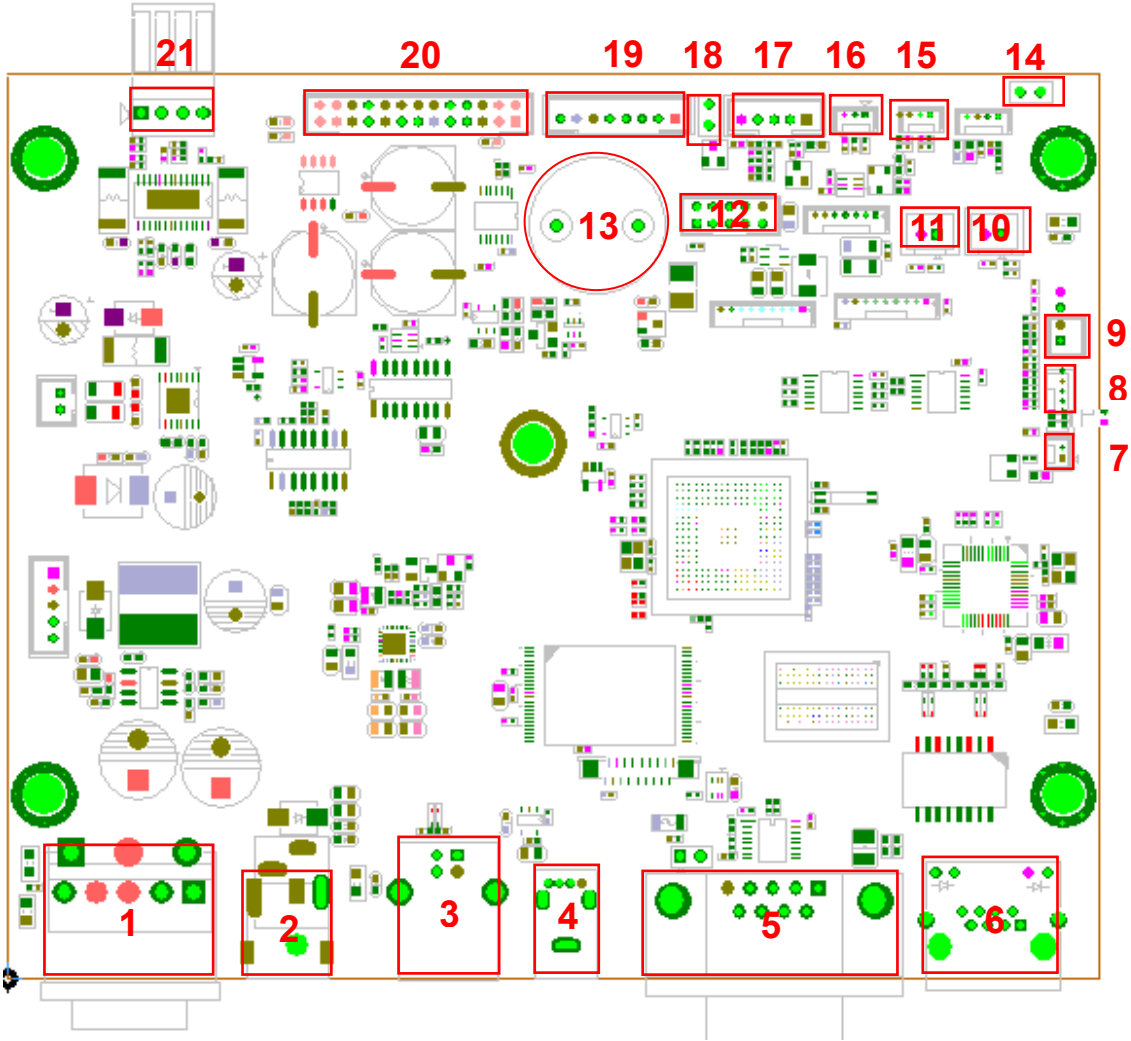

Connector	Description			
1	Switch			
2	DCIN			
3	USB connector			
4	SDRAM			
5	MCU			
6	BT connector			
7	Ribbon Encode connector			
		<b>Pin</b>	<b>Description</b>	<b>Voltage</b>
		1	Power	3.3V
		2	Encoder signal	3.3V
3	GND	0V		
8	Gap sensor emit connector			
		<b>Pin</b>	<b>Description</b>	<b>Voltage</b>
		1	Power	3.3V
2	Gap sensor emitter	Emitter on : 2.1~2.3V Emitter off: 2.6~2.8V		
9	Gap sensor receive connector			
		<b>Pin</b>	<b>Description</b>	<b>Voltage</b>
		1	Power	3.3V
2	Gap sensor receiver AD	0~3.3V		
10	ESD_GND_PIN			
		<b>Pin</b>	<b>Description</b>	<b>Voltage</b>
		1	GND	0V
2	GND	0V		

11	BM sensor connector			
	 <p>J602</p>	<b>Pin</b>	<b>Description</b>	<b>Voltage</b>
		1	Power	3.3V
		2	BM sensor emitter	2.1~2.2V: Emitter on 2.6~2.7V: Emitter off
3	BM sensor receiver	A/D : 0~3.3V		
12	Key& LED connector			
	 <p>J604 KEY/LED</p>	<b>Pin</b>	<b>Description</b>	<b>Voltage</b>
		1	POWER	3.3V
		2	LED Green	LED light on:1.1~1.4V LED light off:1.6~1.9V
		3	LED Red	LED light on:1.4~1.7V LED light off:1.8~2.1V
		4	KEY	0V: Push key 3.3V: Stand-by
5	GND	0V		
13	Head open sensor connector			
	 <p>J603 HEAD_OPEN</p>	<b>Pin</b>	<b>Description</b>	<b>Voltage</b>
		1	Head open switch	0V : Head close 3.3V : Head open
2	GND	0V		
14	KPZ-108-8TAE1-TSCA			
15	Step motor connector			

Main board bottom

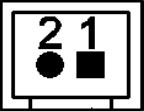

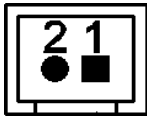
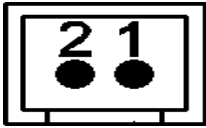
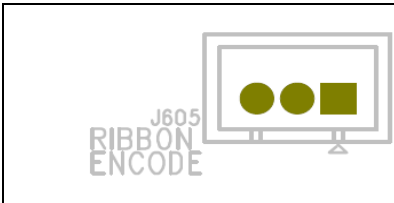
Connector	Description	Remark		
1	Power switch connector	SW1		
2	Power supply (24V DC) connector	DCIN1		
3	USB Device connector	USB1		
4	USB Host connector	USB2		
5	RS-232C connector	RS1		
6	Ethernet connector	LAN1		
7	RTC battery connector	BT1		
8	<b>LED &amp; KEY connector</b>		<b>CON19</b>	
	 <p>J604 KEY/LED</p>	Pin	Description	Voltage
		1	POWER	3.3V
		2	LED Green	LED light on: 1.1~1.4V LED light off: 1.6~1.9V
		3	LED Red	LED light on: 1.4~1.7V LED light off: 1.8~2.1V
		4	KEY	0V: Push key 3.3V: Stand-by
5	GND	0V		
9	<b>Head open sensor connector</b>		<b>CON1</b>	
	 <p>J603 HEAD_OPEN</p>	Pin	Description	Voltage
		1	Head open switch	0V : Head close 3.3V : Head open
2	GND	0V		
10	<b>Gap sensor receiver connector</b>		<b>CON5</b>	
		Pin	Description	Voltage
		1	Power	3.3V
2	Gap sensor receiver AD	0~3.3V		

11	<b>GAP sensor connector (for Transmit signals)</b>			<b>CON20</b>
		<b>Pin</b>	<b>Description</b>	<b>Voltage</b>
		1	Power	3.3V
2	Gap sensor emitter	Emitter on : 2.1~2.3V Emitter off: 2.6~2.8V		
12	<b>Wi-Fi / Bluetooth connector</b>			<b>CON13</b>
13	<b>Buzzer (Factory option)</b>			<b>BZ1</b>
14	<b>ESD_GND_PIN</b>			<b>JP1</b>
		<b>Pin</b>	<b>Description</b>	<b>Voltage</b>
		1	GND	0V
2	GND	0V		
15	<b>Ribbon Encode connector</b>			<b>CON12</b>
		<b>Pin</b>	<b>Description</b>	<b>Voltage</b>
		1	Power	3.3V
		2	Encoder signal	3.3V
3	GND	0V		
16	<b>BM sensor connector</b>			<b>CON21</b>
		<b>Pin</b>	<b>Description</b>	<b>Voltage</b>
		1	Power	3.3V
		2	BM sensor emitter	2.1~2.2V: Emitter on 2.6~2.7V: Emitter off
3	BM sensor receiver	A/D : 0~3.3V		
17	<b>PEEL sensor connector</b>			<b>CON10</b>
		<b>Pin</b>	<b>Description</b>	<b>Voltage</b>
		1	Power	3.3V
2	Reserved			

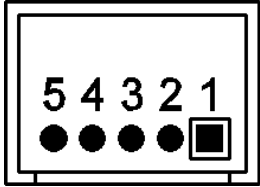
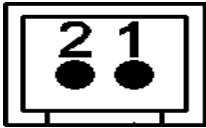
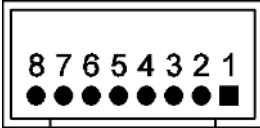
		3	Peel sensor emitter	Emitter on : 2.1~2.3V Emitter off: 2.6~2.8V
		4	Peel sensor receiver AD	0~3.3V
		5	GND	0V
18	<b>ESD_GND_PIN</b>			<b>JP2</b>
		<b>Pin</b>	<b>Description</b>	<b>Voltage</b>
		1	GND	0V
		2	GND	0V
19	<b>Cutter connector</b>			<b>CON6</b>
		<b>Pin</b>	<b>Description</b>	<b>Voltage</b>
		1	Cutter power	24V
		2	GND	0V
		3	Cutter direction	0V: Cutter positive cut 5V: Cutter negative cut
		4	Cutter enable	0V: Cutter work 5V: Cutter stop
		5	Cutter position sensor switch	0V: Cutter stop 3.3V: Cutter work
		6	GND	0V
		7	Logic power	5V
	8	Reserved		
20	<b>Print head connector (TE-210 / TX-310)</b>			<b>CON24</b>
21	<b>STEP_MOTOR connector</b>			<b>CON16</b>

TE210/310 SERIES ONLY:

**RS-232C**

PIN	CONFIGURATION
1	+5 V
2	TXD
3	RXD
4	CTS
5	GND
6	RTS
7	N/C
8	RTS
9	N/C

**USB Device**

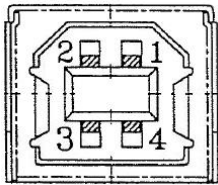

PIN	CONFIGURATION
1	N/C
2	D-
3	D+
4	GND

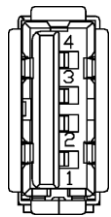

PIN	CONFIGURATION
1	5V
2	D-
3	D+
4	GND

**Ethernet**

<b>PIN</b>	<b>CONFIGURATION</b>
1	Tx+
2	Tx-
3	Rx+
4	N/C
5	N/C
6	Rx-
7	N/C
8	N/C



## 3. Mechanism

Please turn off the power and unplug the power adapter before replacing parts.

### 3.1 Replacing the Platen Roller

1. Open the printer cover. Use a tool to take the platen roller off. Replace the platen roller.



2. Remove the 4 screws on media holder and disengage it.
3. Remove the 2 screws on the print engine which besides the platen roller.

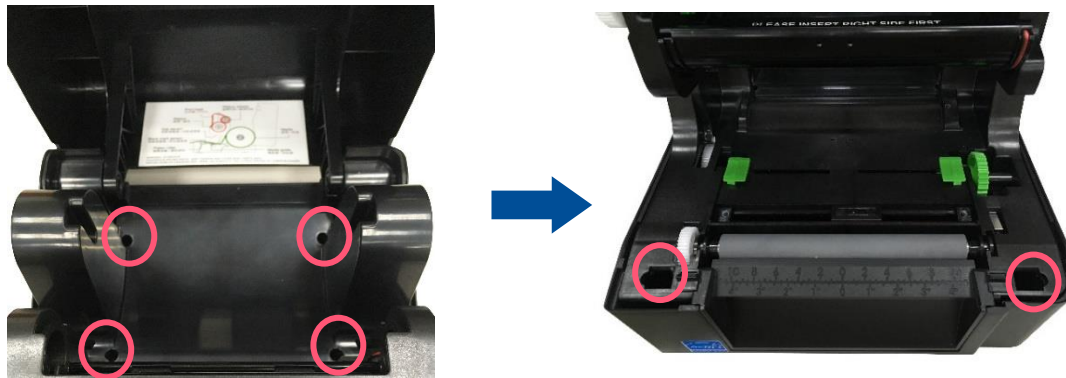

4. Please remove the screw and all of the cables connected to the main board and disengage the print engine.



5. Push the print engine forward and leave the slots, then lift it up to disconnect the print cover assembly.



6. Reassemble the parts in the reverse procedure.



# Print engine mechanism measurements

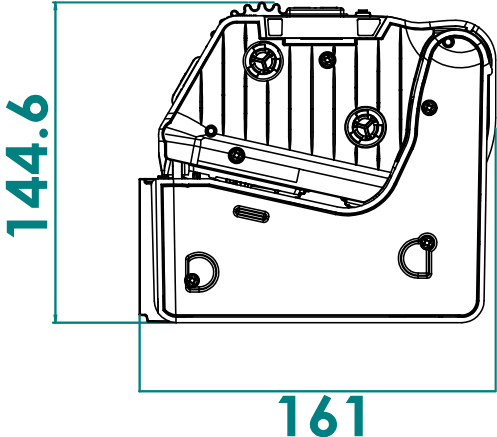
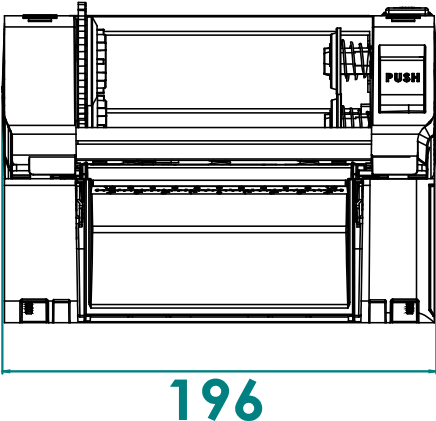

## Bottom View

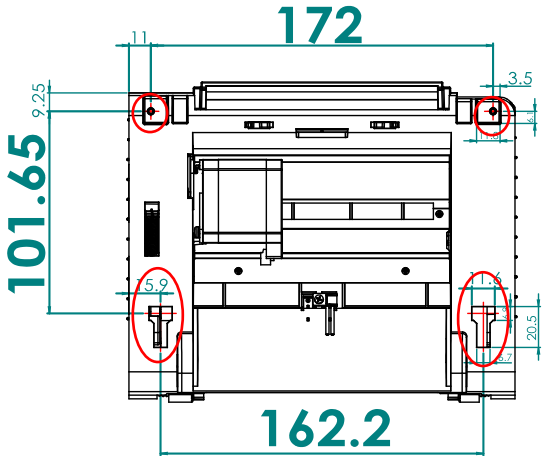

### Note:

- All dimensions in millimeters.
- There are 4 location holes in this print engine mechanism, the fixing location holes are marked in red on bottom view drawing which can be fixed by the customer's reference.

## 3.2 Replacing the Main Board

1. Refer to section 3.1 to remove the printer engine



2. Remove/replace the main board.



3. Reassemble the parts in the reverse procedure.

### 3.3 Replacing the Stepping Motor

1. Please refer to the section 3.1 to remove the print engine mechanism.
2. Turn the print engine mechanism upside down and the stepping motor is installed below as indicated.

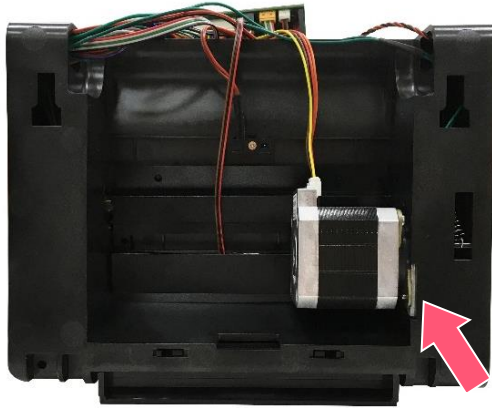

3. Remove the 3 screws on the left side lower cover and open it.

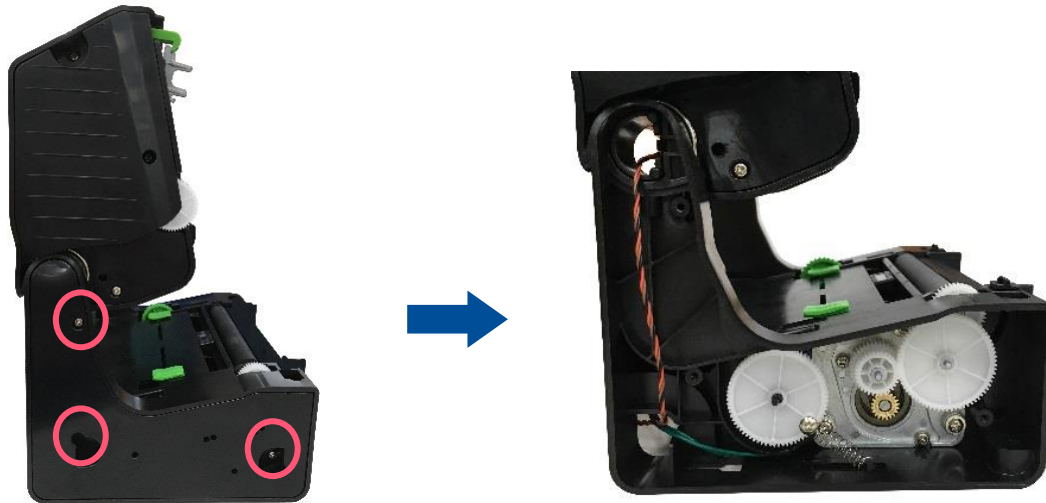

4. After the stepping motor left side lower cover opened, please remove the two screws as indicated to disengage the stepping motor module.

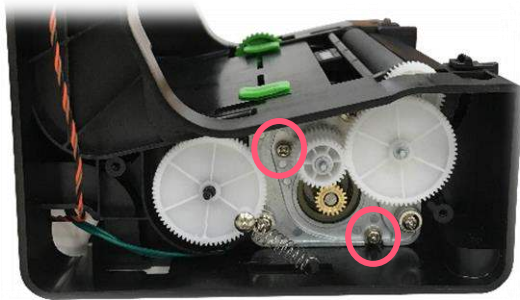

5. Reassemble the parts in the reverse procedures.

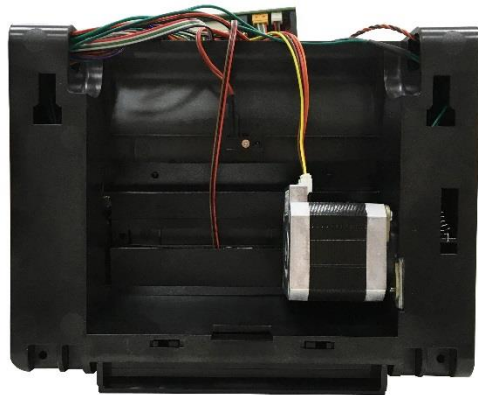

6. Disconnect the stepping motor connectors on the main board.



7. Remove/replace the stepping motor module.
8. Reassemble the parts in the reverse procedure.

## 3.4 Replacing the Gap Sensor Module

1. Please refer to the section 3.1 to remove the print engine.
2. Turn the print engine upside down and remove the screw as indicated.

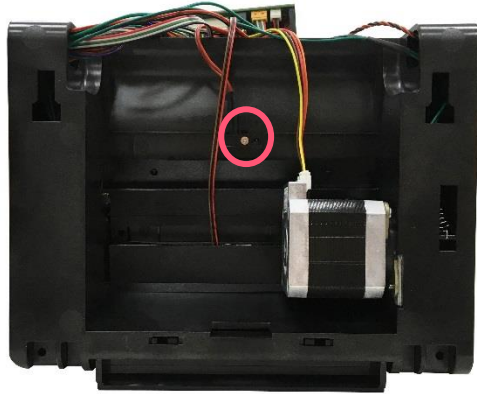

**Screw on Gap Sensor (receiver)**

3. Remove/replace the gap sensor (receiver).



**Gap sensor (receiver)**  
(Fixed position, shift 4 mm to right)

4. Remove the 3 screws on lower print engine right side cover as indicated and open it.



5. Remove/replace the gap sensor emitter.



6. Reassemble the parts in the reverse procedure.



### 3.5 Replacing the Black Mark Sensor Module

1. Please refer to the section 3.3 to remove the stepping motor module.
2. Open the Mylar film cover.

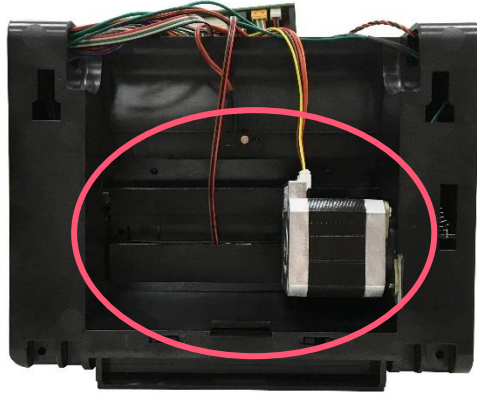

3. Remove the screw on the black-mark sensor module. Remove/replace the black-mark sensor module.



4. Reassemble the parts in the reverse procedure.

## 3.6 Replacing the Platen Roller Assembly

1. Open the printer top cover then push the print head release button to open the print head mechanism.
2. Remove the lower front panel.



3. Disengage the platen roller by pulling out the tabs located on each side. Rotate the tabs into the upward position. (see pictures below)

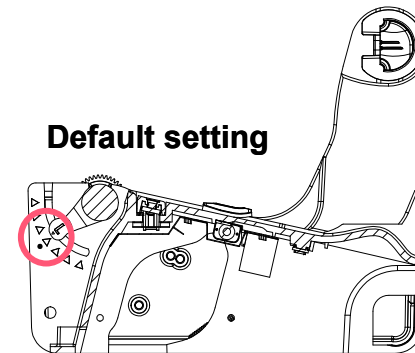
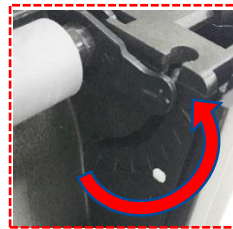

4. Pulling upward to remove/replace the platen roller assembly.



6. Reassemble the parts in the reverse procedure.

## 3.7 Replacing the Stepping Motor

1. Open the printer top cover and press the print head release button to open the print head mechanism.
2. Disengage the print head module by push it forward and leave the slots as indicated.

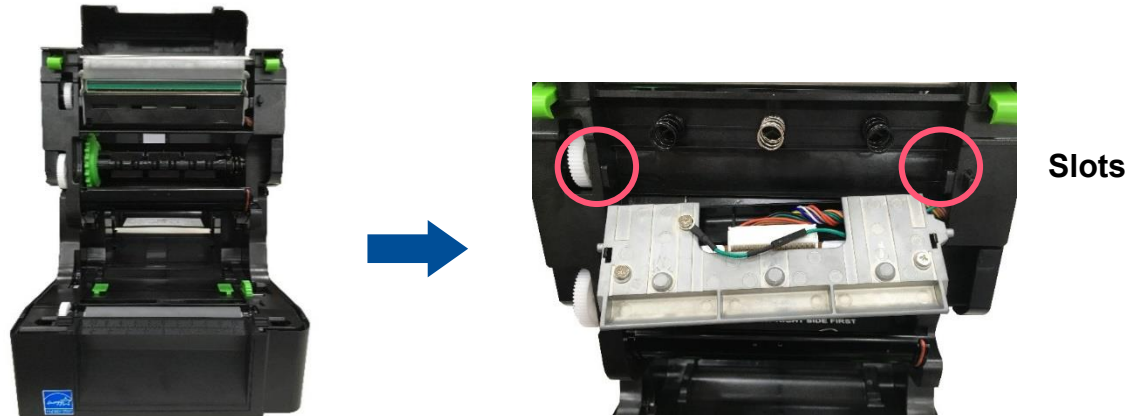

3. Disconnect the ground line (green cable) and print head harness.
4. Push down and release the print head bracket hooks as indicated.

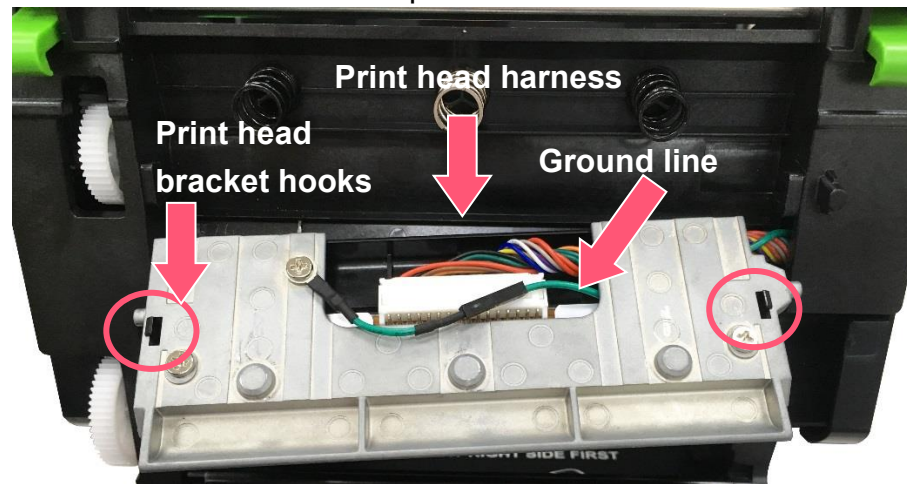

5. Push the front tab of the print head bracket to the right side and open the print head bracket as pictured.

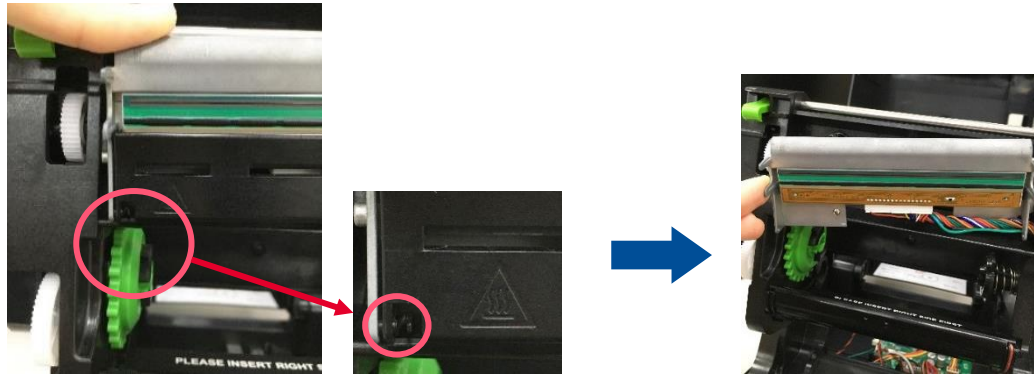

6. Remove/Replace the print head assembly.

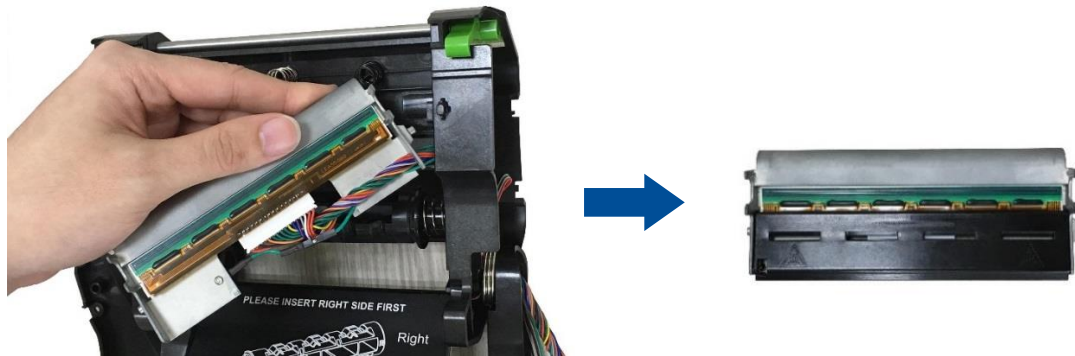

7. Reassemble the parts in the reverse procedures.

## 3.8 Installing the Cutter Module (TE210/TE310 Series Option)

1. Open the printer top cover by pressing the top cover open tabs located on each side of the printer.



2. Push the print head release button to open the print head mechanism.
3. Remove the lower front panel.



4. Insert the cable and ground line of cutter module through the hole as indicated to the main board.
5. Remove the four screws on media holder and disengage it.



6. Connect the cable and ground line to the socket on main board as indicated.

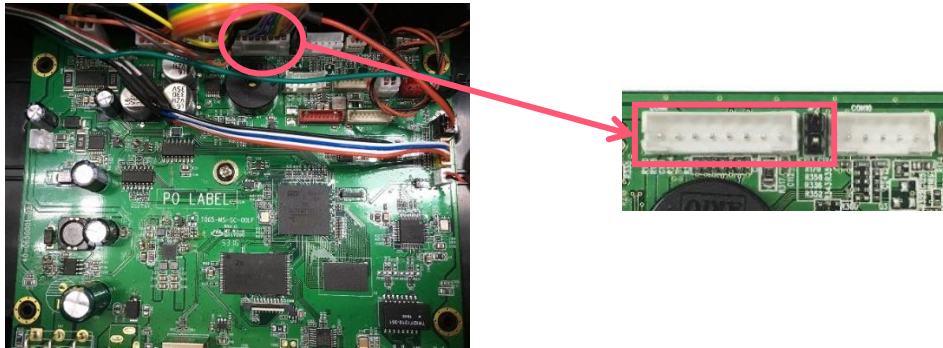

7. Push down the cutter module and fix on the lower front panel location hole.

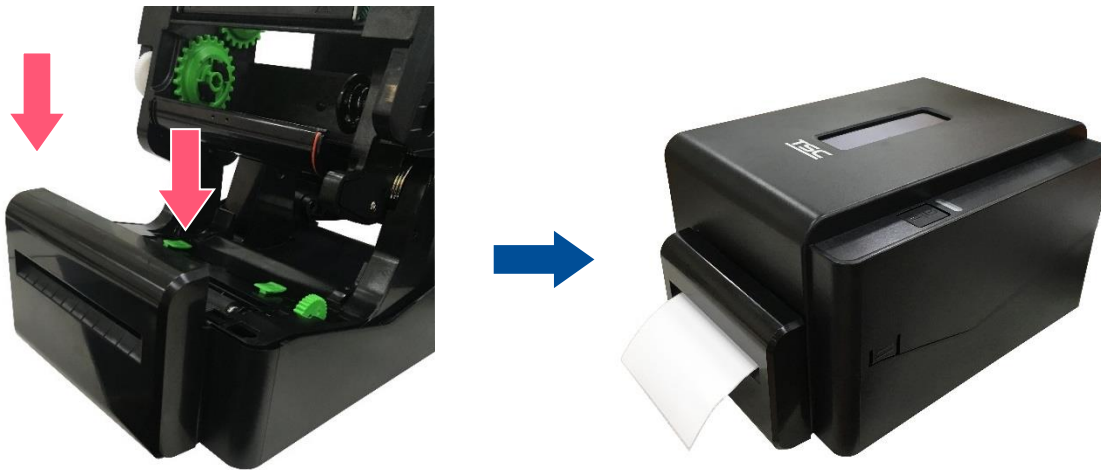

8. Complete the installation of cutter module.
9. Reassemble the parts in the reverse procedures.



### 3.9 Installing the Peeler Module (TE210/TE310 Series Option)

1. Open the printer top cover by pressing the top cover open tabs located on each side of the printer.



2. Push the print head release button to open the print head mechanism and remove the lower front panel.



3. Insert the cable and ground line of peeler module through the hole as indicated to the main board.
4. Remove the four screws on media holder and disengage it.



5. Connect the cable and ground line to the socket on main board as indicated.

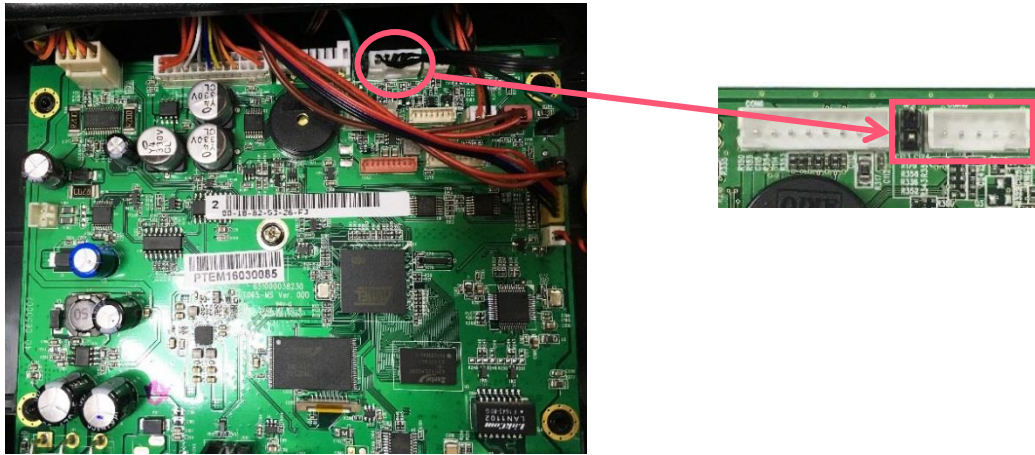

6. Push down the cutter module and fix on the lower front panel location hole.

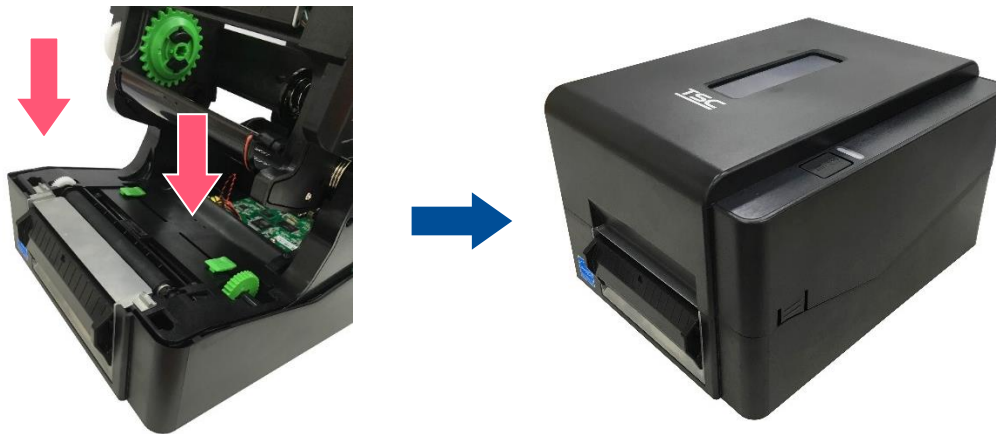

7. Complete the installation of cutter module.
8. Reassemble the parts in the reverse procedures.



## 3.10 Replacing the Key Module (LCE MODULE / Option)

1. Please refer to the section 3.1 to take out the print engine mechanism.
2. Remove the three screws on right side upper cover and open it.



3. After the right side upper cover opened, please disengage the LED module.
4. Remove the two screws and cable on the LED key module.

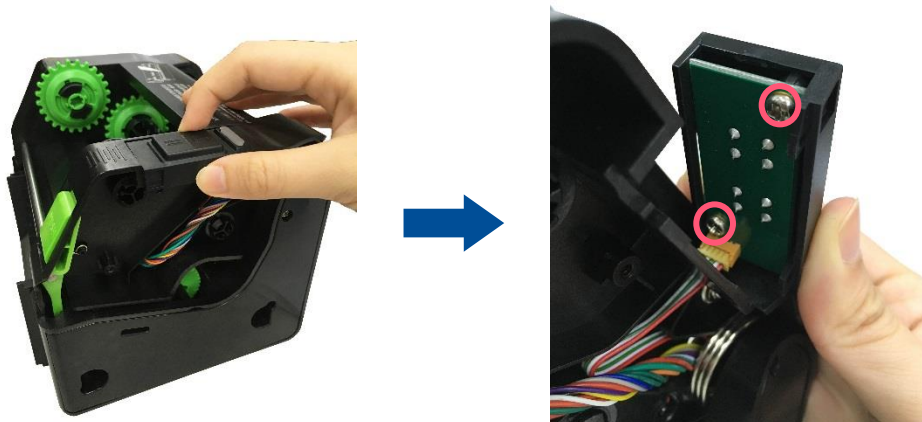

5. Remove/replace the LED key module
6. Reassemble the parts in the reverse procedures.

## 3.11 Replacing the Print Head Open Sensor Assembly

1. Please refer to the section 3.1 to remove the print engine.
2. Disconnect the three screws to remove the right side lower cover.



3. Remove the print head open sensor by disengage the screw and cable (black) as indicated.



4. Reassemble the parts in the reverse procedure.

## 3.12 Replacing the Encoder Assembly

1. Please refer to Ch.3.1 to uninstall the print engine mechanism.



2. Open the print engine mechanism, and then turn to left side to disconnect six screws as indicated to remove upper and lower cover.

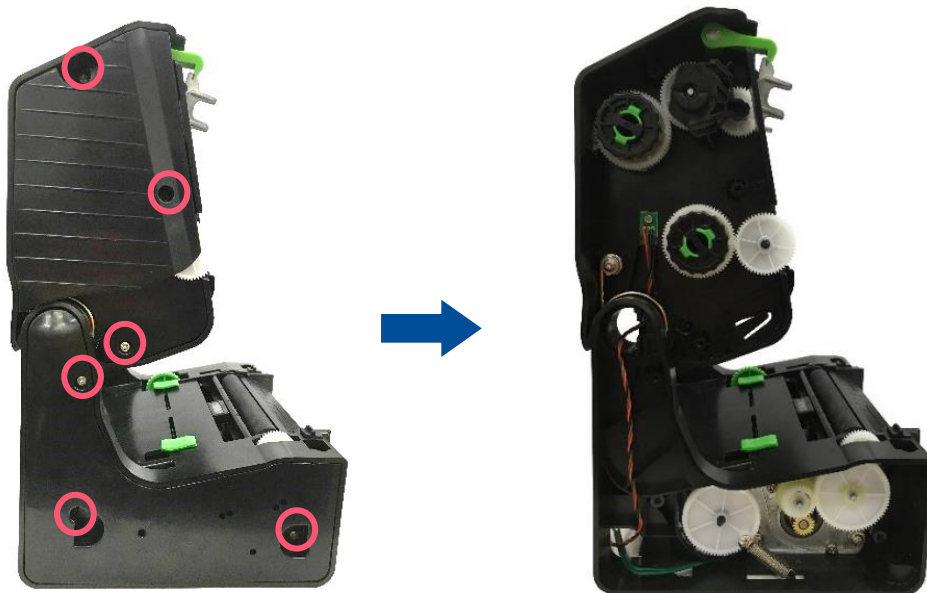

- 3.** Remove the screw on the Encoder assembly.



- 4.** Push the latch on ribbon base hinge to left side, pull out the ribbon base hinge and remove the Encoder assembly.



- 5.** Reassemble the parts in the reverse procedure.

### 3.13 Replacing the Label Guide Module

1. Please check the direction of label guide (L: Left; R: Right).

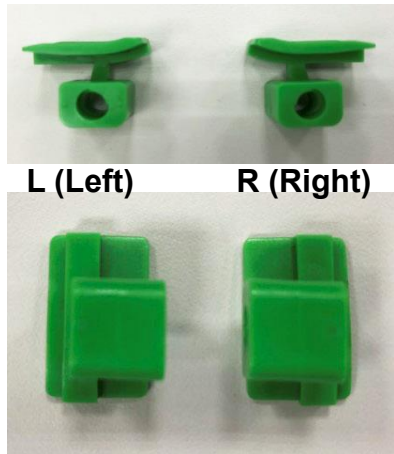

2. Check label guide shaft direction. The bottom side has round marks as indicated.

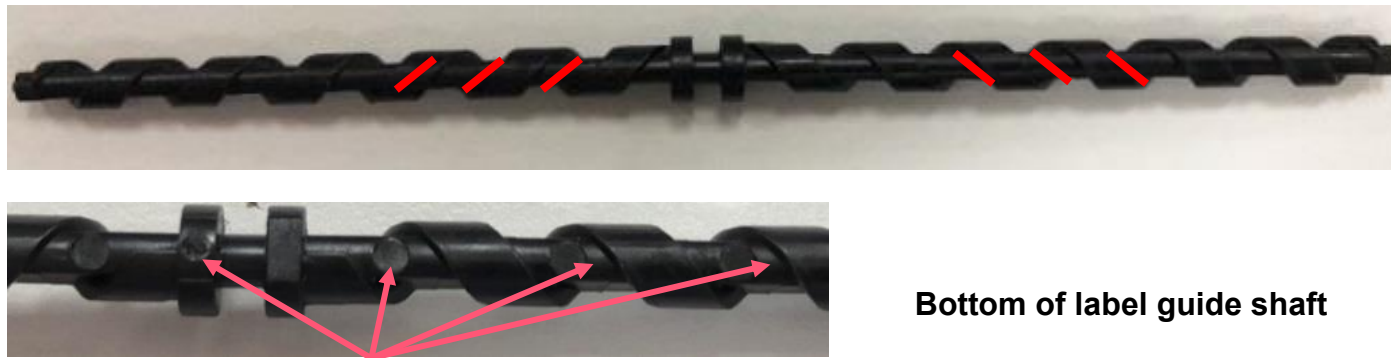

Bottom of label guide shaft

- 3.** Place the label guide shaft as below. The round mark is at the bottom side. Please notice about the placement position 1, 2, and 3 at right side and left side.

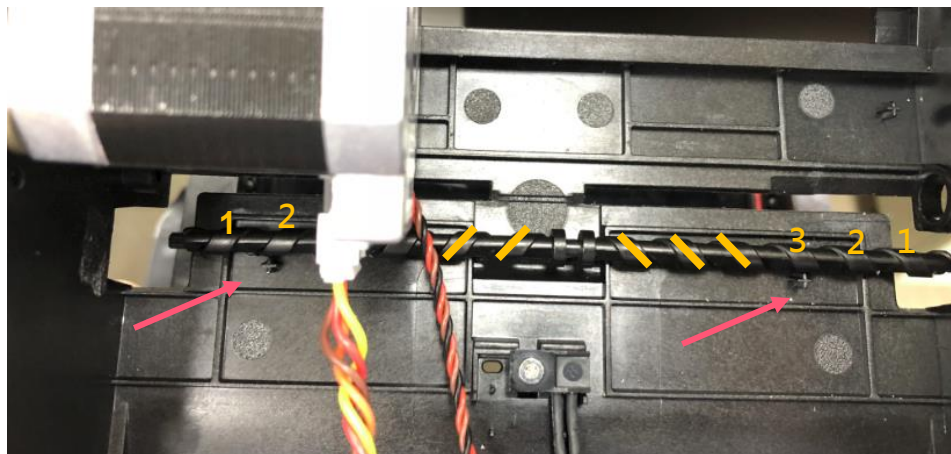

- 4.** Push the label guide R and L to the shaft.





5. Push the label guide R and L to the shaft and touch the cover.



6. Push the label guide R and L upward.



7. Push the label guides to the end of center.

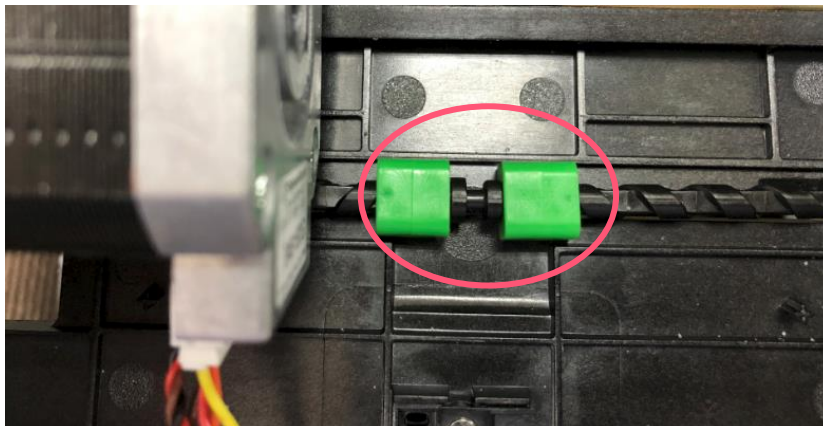

Check if the shaft is fit to the fix hole of the mechanism.

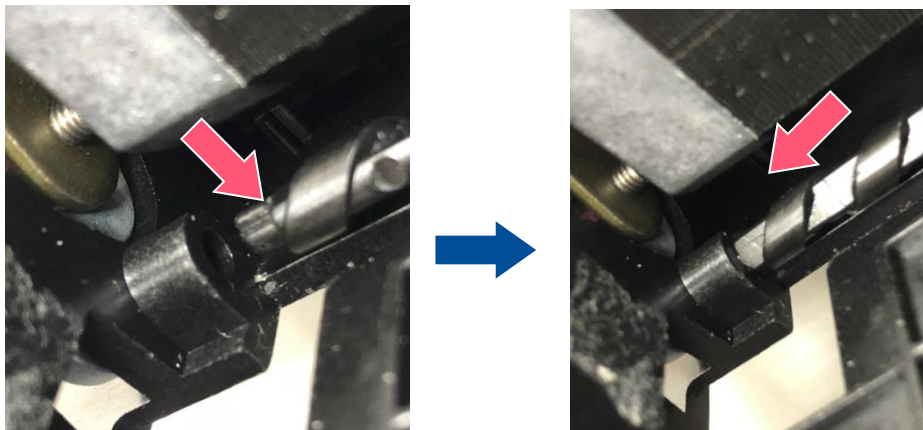

**8.** Install the knob to the shaft.

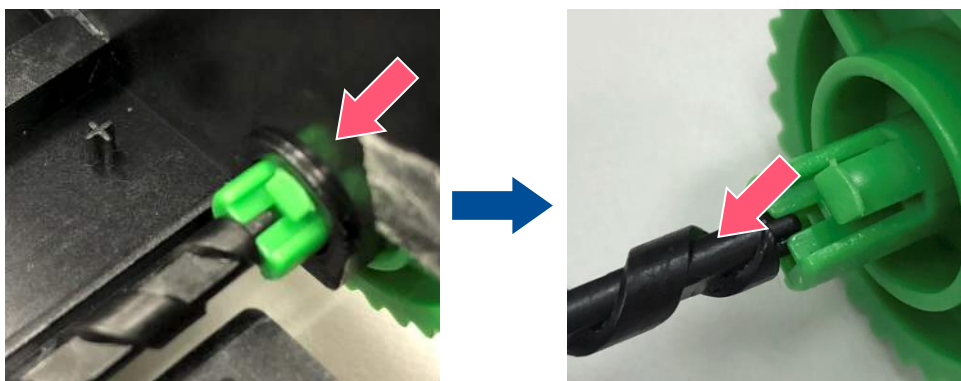

**9.** Reassemble the parts in the reverse procedures.



## 3.14 Replacing Wi-Fi module Assembly (TE210/TE310 Series option)

1. Please refer to the section 3.1 to remove the print engine.
2. Remove the three screws on lower print engine right side cover as indicated and open it.

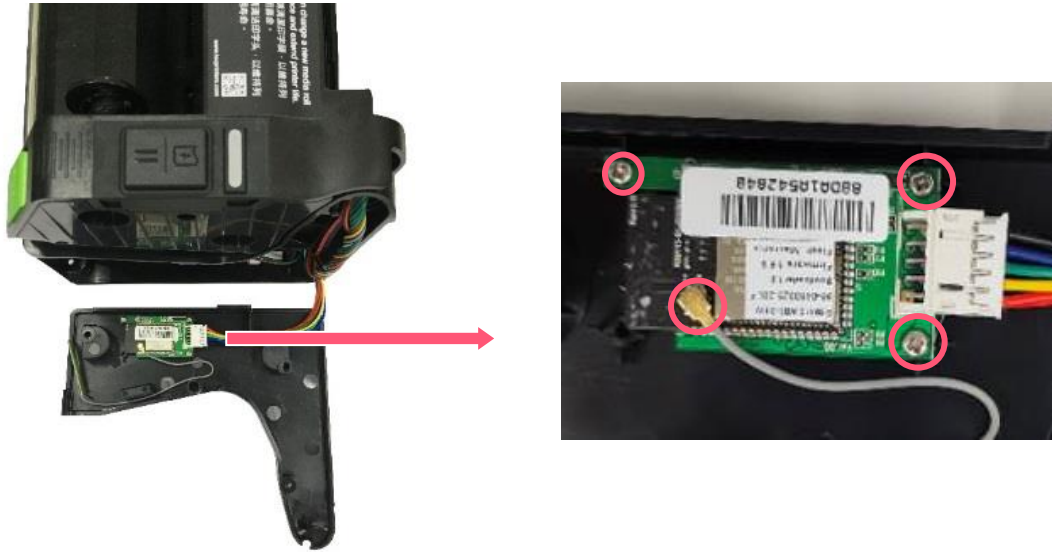

Remove the three screws on Wi-Fi module assembly and disconnect the connectors. Remove/Replace the Wi-Fi module assembly. Reassemble the parts in the reverse procedure.

### Note:

The Wi-Fi module and bluetooth module are not coexistence.

When install the Wi-Fi module assembly, please follow the cable loading path as shown.

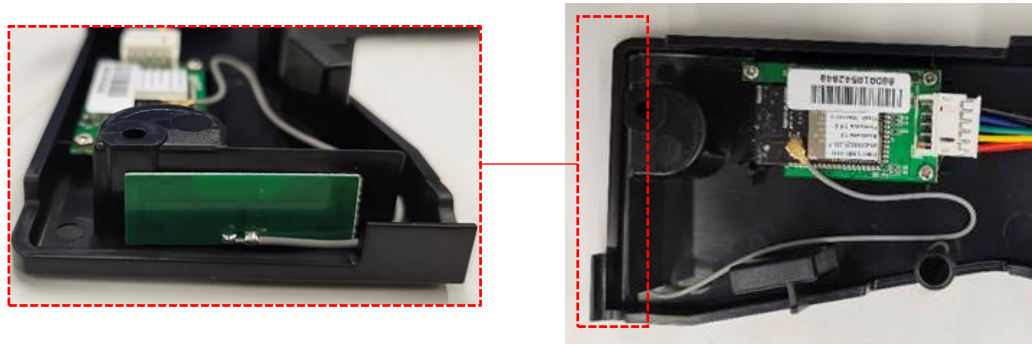

## 4. Troubleshooting

Problem	Possible Cause	Recovery Procedure
Power indicator does not illuminate.	<ul style="list-style-type: none"> <li>* The power cord is not properly connected.</li> </ul>	<ul style="list-style-type: none"> <li>* Plug the power cord in printer and outlet.</li> <li>* Switch the printer on.</li> </ul>
<ul style="list-style-type: none"> <li>-The printer status from TSC Console shows “Head Open”.</li> <li>- The LED shows “Red (solid)”.</li> </ul>	<ul style="list-style-type: none"> <li>* The printer carriage is open.</li> </ul>	<ul style="list-style-type: none"> <li>* Please close the print carriage.</li> </ul>
<ul style="list-style-type: none"> <li>- The printer status from TSC Console shows “Ribbon End Err.” Or “Ribbon Encoder Err.”</li> <li>- The LED shows “Red (blinking)”.</li> </ul>	<ul style="list-style-type: none"> <li>* Running out of ribbon.</li> <li>* The ribbon is installed incorrectly.</li> </ul>	<ul style="list-style-type: none"> <li>* Supply a new ribbon roll.</li> <li>* Please refer to the steps on section 3.2 to re-install the ribbon.</li> </ul>
<ul style="list-style-type: none"> <li>- The printer status from TSC Console shows “Out of Paper”.</li> <li>- The LED shows “Red (blinking)”.</li> </ul>	<ul style="list-style-type: none"> <li>* Running out of label.</li> <li>* The label is installed incorrectly.</li> <li>* Gap/black mark sensor is not calibrated.</li> </ul>	<ul style="list-style-type: none"> <li>* Supply a new label roll.</li> <li>* Calibrate the gap/black mark sensor.</li> </ul>
<ul style="list-style-type: none"> <li>- The printer status from TSC Console shows “Paper Jam”.</li> <li>- The LED shows “Red (blinking)”.</li> </ul>	<ul style="list-style-type: none"> <li>* Gap/black mark sensor is not set properly.</li> <li>* Make sure label size is set properly.</li> <li>* Labels may be stuck inside the printer mechanism.</li> </ul>	<ul style="list-style-type: none"> <li>* Calibrate the gap/black mark sensor.</li> <li>* Set label size correctly.</li> </ul>
Not Printing	<ul style="list-style-type: none"> <li>* Cable is not well connected to serial or USB interface or parallel port.</li> <li>* The serial port cable pin configuration is not pin to pin connected.</li> </ul>	<ul style="list-style-type: none"> <li>* Re-connect cable to interface.</li> <li>* Change a new cable.</li> <li>* Ribbon and media are not compatible.</li> <li>* Verify the ribbon-inked side.</li> <li>* Reload the ribbon again.</li> <li>* Clean the print head.</li> <li>* The print density setting is incorrect.</li> <li>* Print head’s harness connector is not well connected with printhead. Turn off the printer and plug the connector again.</li> <li>* Check your program if there is a command PRINT at the</li> </ul>

		end of the file and there must have CRLF at the end of each command line.
Memory full ( FLASH / DRAM )	* The space of FLASH/DRAM is full.	* Delete unused files in the FLASH/DRAM.
Poor Print Quality	<ul style="list-style-type: none"> <li>* Ribbon and media is loaded incorrectly</li> <li>* Dust or adhesive accumulation on the print head.</li> <li>* Print density is not set properly.</li> <li>* Printhead element is damaged.</li> <li>* Ribbon and media are incompatible.</li> </ul>	<ul style="list-style-type: none"> <li>* Reload the supply.</li> <li>* Clean the print head.</li> <li>* Clean the platen roller.</li> <li>* Adjust the print density and print speed.</li> <li>* Run printer self-test and check the print head test pattern if there is dot missing in the pattern.</li> <li>* Change proper ribbon or proper label media.</li> <li>* The print head mechanism does not latch the print head properly.</li> </ul>
Skip labels when printing	<ul style="list-style-type: none"> <li>* Label size is not specified properly.</li> <li>* Sensor sensitivity is not set properly.</li> <li>* The media sensor is covered with dust.</li> </ul>	<ul style="list-style-type: none"> <li>* Check if label size is setup correctly.</li> <li>* Calibrate the sensor by Auto Gap or Manual Gap options.</li> <li>* Clear the GAP/Black mark sensor by blower.</li> </ul>
The printing position of small label is incorrect	<ul style="list-style-type: none"> <li>* Media sensor sensitivity is not set properly.</li> <li>* Label size is incorrect.</li> <li>* The vertical offset setting in the driver is incorrect.</li> </ul>	<ul style="list-style-type: none"> <li>* Calibrate the sensor sensitivity again.</li> <li>* Set the correct label size and gap size.</li> <li>* If using the software BarTender, please set the vertical offset in the driver.</li> </ul>

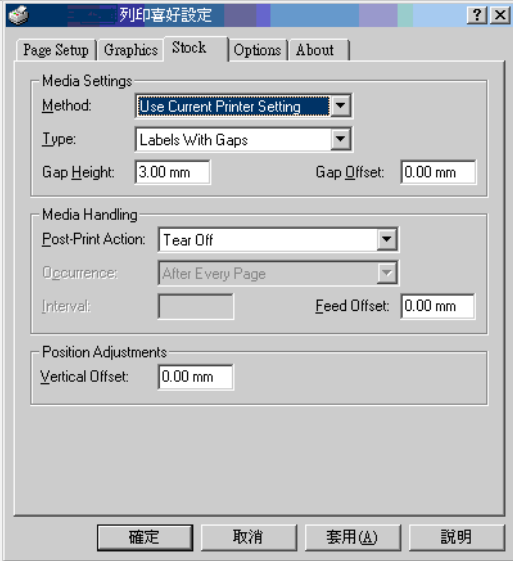
		
Missing printing on the left or right side of label	* Wrong label size setup.	* Set the correct label size.
Wrinkle problem	<ul style="list-style-type: none"> <li>* Ribbon installation is incorrect.</li> <li>* Media installation is incorrect.</li> <li>* Print density is incorrect.</li> <li>* Media feeding is incorrect.</li> </ul>	<ul style="list-style-type: none"> <li>* Please set the suitable density to have good print quality.</li> <li>* Make sure the label guide touch the edge of the media guide.</li> </ul>
Gray line on the blank label	<ul style="list-style-type: none"> <li>* The print head is dirty.</li> <li>* The platen roller is dirty.</li> </ul>	<ul style="list-style-type: none"> <li>* Clean the print head.</li> <li>* Clean the platen roller.</li> </ul>
Irregular printing	* The printer is in Hex Dump mode.	* Turn off and on the printer to skip the dump mode.

# 5. Maintenance

This session presents the clean tools and methods to maintain the printer.

## ■ For Cleaning

Depending on the media used, the printer may accumulate residues (media dust, adhesives, etc.) as a by-product of normal printing. To maintain the best printing quality, you should remove these residues by cleaning the printer periodically. Regularly clean the print head and supply sensors once change a new media to keep the printer at the optimized performance and extend printer life.

## ■ For Disinfecting

Sanitize your printer to protect yourself and others and can help prevent the spread of viruses.

## ■ Important

- Set the printer power switch to O (Off) prior to performing any cleaning or disinfecting tasks. Leave the power cord connected to keep the printer grounded and to reduce the risk of electrostatic damage.
- Do not wear rings or other metallic objects while cleaning any interior area of the printer.
- Use only the cleaning agents recommended in this document. Use of other agents may damage the printer and void its warranty.
- Do not spray or drip liquid cleaning solutions directly into the printer. Apply the solution on a clean lint-free cloth and then apply the dampened cloth to the printer.
- Do not use canned air in the interior of the printer as it can blow dust and debris onto sensors and other critical components.
- Only use a vacuum cleaner with a nozzle and hose that are conductive and grounded to drain off static build up.
- All reference in these procedures for use of isopropyl alcohol requires that a 99% or greater isopropyl alcohol content be used to reduce the risk of moisture corrosion to the printhead.
- Do not touch printhead by hand. If you touch it carelessly, please use 99% Isopropyl alcohol to clean it.
- Always taking personal precaution when using any cleaning agent.

## Cleaning Tools

- Cotton swab
- Lint-free cloth
- Brush with soft non-metallic bristles
- Vacuum cleaner
- 75% Ethanol (for disinfecting)
- 99% Isopropyl alcohol (for printhead and platen roller cleaning)
- Genuine printhead cleaning pen
- Mild detergent (without chlorine)

## Cleaning Process:

Printer Part	Method	Interval
<b>Print Head</b>	<ol style="list-style-type: none"> <li>I. Always turn off the printer before cleaning the printhead.</li> <li>II. Allow the printhead to cool for at least one minute.</li> <li>III. Use a cotton swab and 99% Isopropyl Alcohol or genuine print head cleaning pen to clean the print head surface.</li> </ol>	Clean the print head when changing a new label roll.
<b>Platen Roller</b>	<ol style="list-style-type: none"> <li>I. Turn off the printer.</li> <li>II. Rotate the platen roller and wipe it thoroughly with the lint-free 99% Isopropyl Alcohol.</li> </ol>	Clean the platen roller when changing a new label roll
<b>Peel Bar</b>	Use the lint-free cloth with 99% Isopropyl Alcohol to wipe it.	As needed
<b>Sensor</b>	Use brush with soft non-metallic bristles or a vacuum cleaner, to remove paper dust. Clean upper and lower media sensors to ensure reliable Top of Form and Paper Out sensing.	Monthly
<b>Exterior</b>	Clean the exterior surfaces with a clean, lint-free cloth (water-dampened cloth). If necessary, use a mild detergent or desktop cleaning solution then use the 75% Ethanol to wipe it.	As needed
<b>Interior</b>	Clean the interior of the printer by removing any dirt and lint with a vacuum cleaner, as described above, or use a brush with soft non-metallic bristles then use the 75% Ethanol to wipe it.	As needed

# Revise History

Date	Content	Editor
2023/7/11	Modify the Installing the Peeler Module section	Camille

**TSC** **PRINTRONIX**<sup>®</sup>  
**AUTO ID**