

Desktop Barcode Printer

TH240 Series

Thermal Transfer • Direct Thermal

Series Models

TH240 / TH340

TH240T / TH340T

TH240THC / TH340THC



Service Manual

Copyright Information

© 2023 TSC Auto ID Technology Co., Ltd.

The copyright in this manual, the software and firmware in the printer described are owned by TSC Auto ID Technology Co., Ltd. All rights reserved.

CG Triumvirate is a trademark of Agfa Corporation. CG Triumvirate Bold Condensed font is under license from the Monotype Corporation. Windows is a registered trademark of Microsoft Corporation.

All other trademarks are the property of their respective owners. Information in this document is subject to change without notice and does not represent a commitment on the part of TSC Auto ID Technology Co. No part of this manual may be reproduced or transmitted in any form or by any means, for any purpose other than the purchaser's personal use, without the expressed written permission of TSC Auto ID Technology Co.



Contents

1	Introduction	4
1.1	Printer Features.....	5
2	Electronics	8
2.1	Summary of the Board Connectors	8
2.2	Interface Pin Configuration	19
3	Replacing Parts	21
3.1	Before You Begin.....	21
3.2	Replacing the Platen Roller Assembly.....	22
3.3	Replacing the Printhead Assembly.....	24
3.4	Replacing the Top Cover	27
3.5	Replacing the Control Panel Assembly	28
3.6	Replacing the Lower Cover	31
3.7	Replacing the RTC Module	33
3.8	Replacing the Main Board	34
3.9	Replacing the SD Card Board	35
3.10	Replacing the Stepping Motor	36
3.11	Replacing the DC Motor Module/ Ribbon Encoder Sensor	37
3.12	Replacing the Ribbon End Sensor	38
3.13	Replacing the Black Mark Sensor	39
3.14	Replacing the Head Open Sensor.....	40
3.15	Replacing the Printer Cover Hook.....	41
3.16	Installing the Wi-Fi/ Bluetooth Module	42
3.17	Installing the Cutter Module.....	45
3.18	Installing the Peel-off Module	47

3.19	Installing the Narrow Media Adaptor.....	50
4	Troubleshooting.....	52
4.1	Common Problems.....	52
5	Maintenance	57
	Revision History.....	60

1 Introduction

Thank you very much for purchasing TSC bar code printer.

The TH/DH240 series of thermal desktop barcode printers support more printing applications than any other printer in its class. The four-inch wide TH/DH240 series can address everything from higher volume 4x6 shipping labels, higher resolution product marking and graphic solutions, to high resolution labels used in electronics marking applications.

The TH/DH240 series features a user-friendly spring-loaded center-biased clamshell design for easy drop-in media loading of 5-inch rolls of media. The printer construction features a rugged double-wall design that is stronger and more durable than other thermal transfer mechanisms on the market. Its strong motor is powerful enough to handle a 300-meter-long ribbon.

As with all TSC printers, the TH/DH240 Series features the TSPL-EZD printer-control language, which is fully compatible with other TSC printer languages, while supporting TPLE (Translation Printer Language Eltron®), TPLZ (Translation Printer Language Zebra®) and TPLD (Translation Printer Language Datamax®). The languages automatically decipher and translate the format of each label as it is sent to the printer. TSPL-EZD also features internal scalable True Type fonts (based on the Monotype® font engine), which are typically found only in more expensive printers.

1.1 Printer Features

Front View

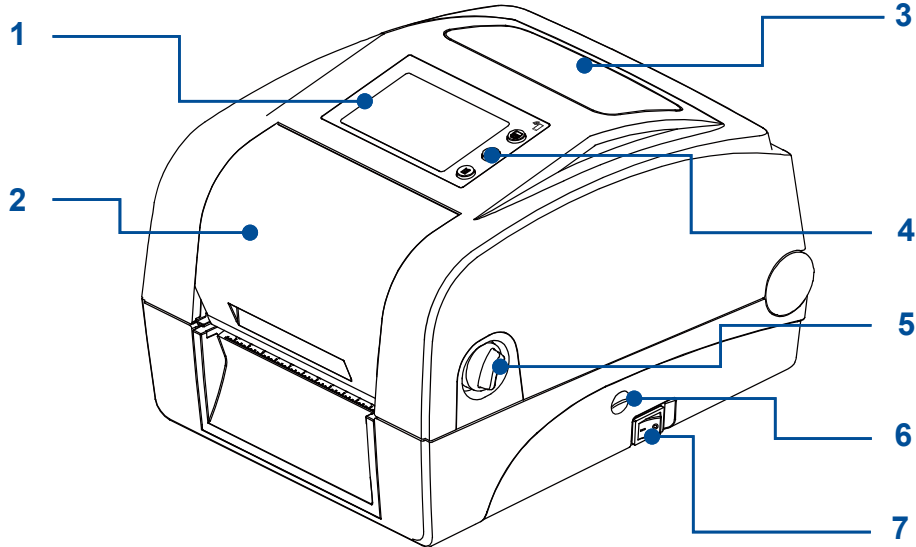

- 1. LCD
- 2. Ribbon access cover
- 3. Media viewer window
- 4. Operating buttons
- 5. Cover lever
- 6. microSD card slot
- 7. Power switch

Interior View

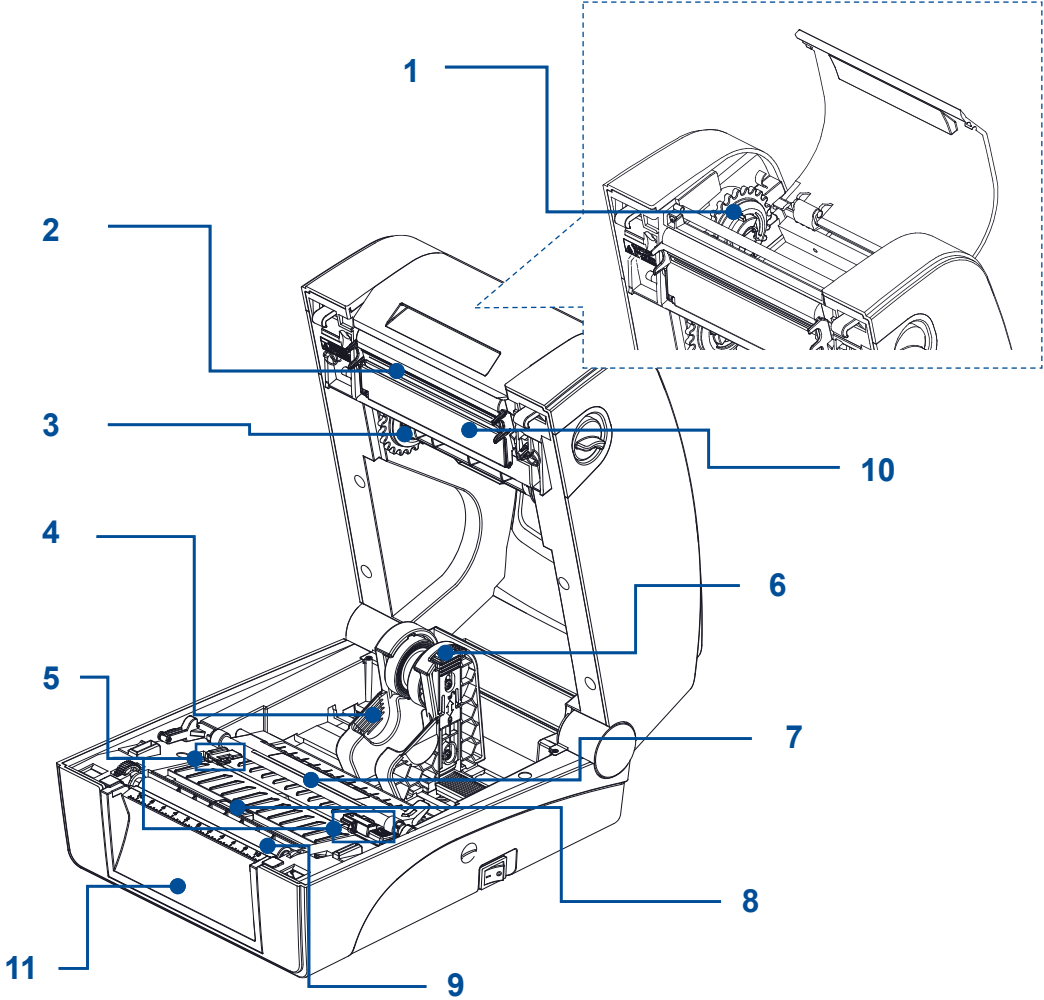

- 1. Ribbon rewind hub
- 2. Printhead
- 3. Ribbon supply hub
- 4. Media holder
- 5. Media guide
- 6. Media holder lock
- 7. Media damper
- 8. Black mark sensor
- 9. Platen roller
- 10. Printhead cover
- 11. Front panel cover

Rear View

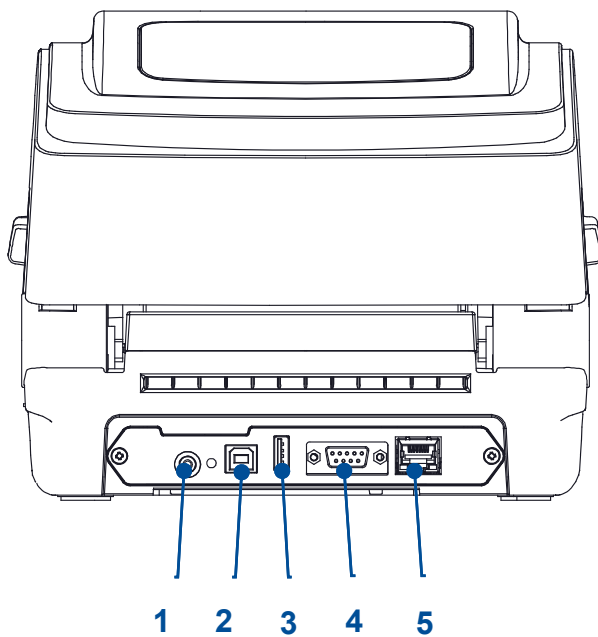

1. Power Jack
2. USB interface
3. USB host
4. RS-232C interface
5. Ethernet LAN port

2 Electronics

2.1 Summary of the Board Connectors

Main board

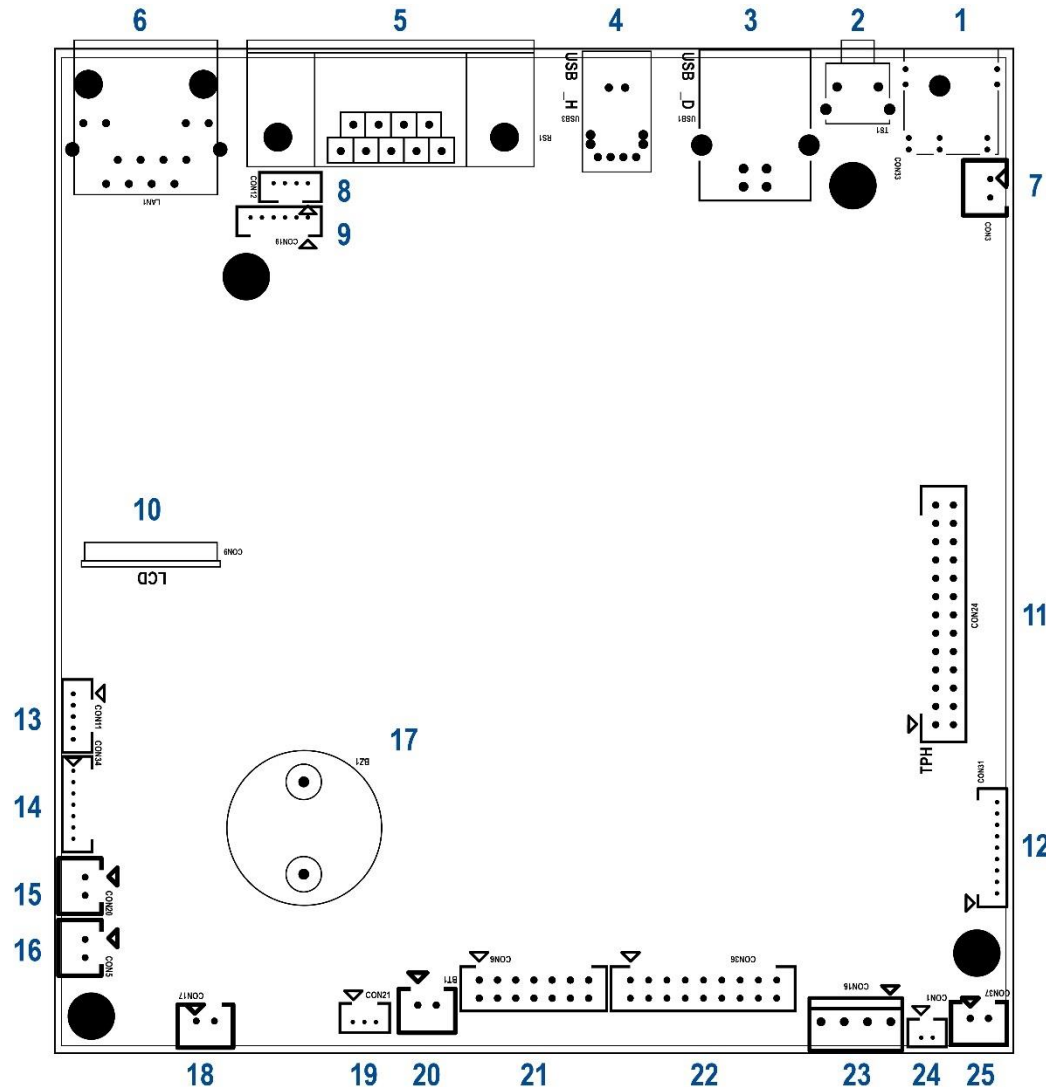

1. Power supply output (24V DC) connector
2. System reset switch
3. USB device connector
4. USB host connector
5. RS-232C connector
6. Ethernet connector
7. ESD cable connector
8. Ribbon sensor connector
9. Panel touch and key connector
10. LCD connector
11. TPH connector
12. Micro SD card connector
13. Ribbon end sensor connector
14. NFC
15. Gap sensor connector (for transmit signals)
16. Gap sensor connector (for receive signals)
17. Buzzer
18. DC motor connector
19. Black mark sensor connector
20. Coin battery connector
21. Cutter / Peeler / RFID connector
22. Wi-Fi & Bluetooth connector
23. Stepping motor connector
24. Head open connector
25. Power switch connector

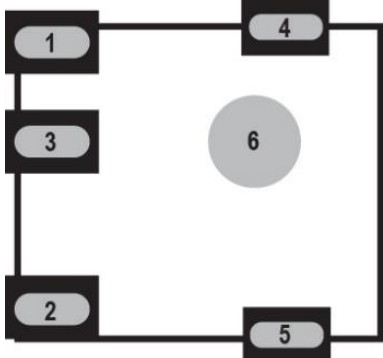
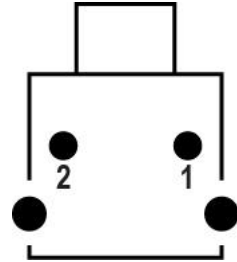
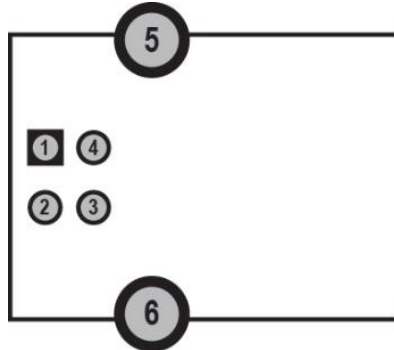
No.	Function	Pin Definition												
1	<p>Power supply output (24V DC) connector</p> 	<table border="1"> <thead> <tr> <th>No.</th> <th>Definition</th> </tr> </thead> <tbody> <tr> <td>1</td> <td>DCIN 24V</td> </tr> <tr> <td>2</td> <td>GND</td> </tr> <tr> <td>3</td> <td>GND</td> </tr> <tr> <td>4</td> <td>GND</td> </tr> <tr> <td>5</td> <td>GND</td> </tr> </tbody> </table>	No.	Definition	1	DCIN 24V	2	GND	3	GND	4	GND	5	GND
No.	Definition													
1	DCIN 24V													
2	GND													
3	GND													
4	GND													
5	GND													
2	<p>System reset switch (for resetting RTC or when printer hangs)</p> 	<table border="1"> <thead> <tr> <th>No.</th> <th>Definition</th> </tr> </thead> <tbody> <tr> <td>1</td> <td>Vbattery</td> </tr> <tr> <td>2</td> <td>VDDBU reset signal</td> </tr> </tbody> </table>	No.	Definition	1	Vbattery	2	VDDBU reset signal						
No.	Definition													
1	Vbattery													
2	VDDBU reset signal													
3	<p>USB device connector</p> 	<table border="1"> <thead> <tr> <th>No.</th> <th>Definition</th> </tr> </thead> <tbody> <tr> <td>1</td> <td>NC</td> </tr> <tr> <td>2</td> <td>D-</td> </tr> <tr> <td>3</td> <td>D+</td> </tr> <tr> <td>4</td> <td>GND</td> </tr> </tbody> </table>	No.	Definition	1	NC	2	D-	3	D+	4	GND		
No.	Definition													
1	NC													
2	D-													
3	D+													
4	GND													

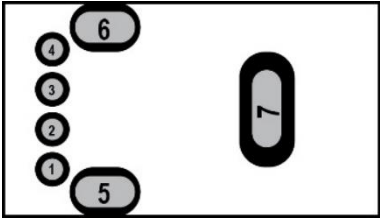
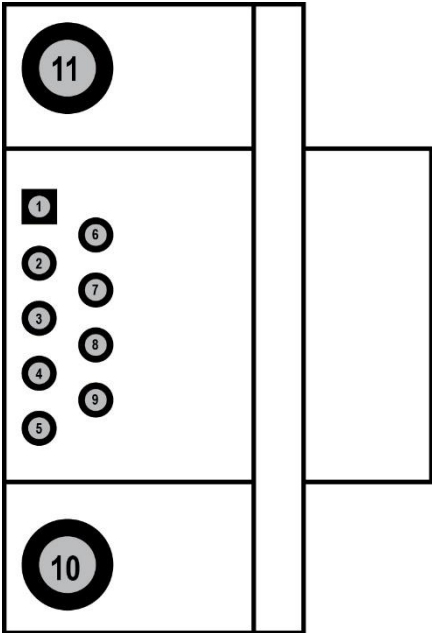
No.	Function	Pin Definition																			
4	USB host connector																				
		<table border="1"> <thead> <tr> <th>No.</th> <th>Definition</th> </tr> </thead> <tbody> <tr> <td>1</td> <td>VBUS 5V</td> </tr> <tr> <td>2</td> <td>D-</td> </tr> <tr> <td>3</td> <td>D+</td> </tr> <tr> <td>4</td> <td>GND</td> </tr> </tbody> </table>	No.	Definition	1	VBUS 5V	2	D-	3	D+	4	GND									
No.	Definition																				
1	VBUS 5V																				
2	D-																				
3	D+																				
4	GND																				
5	RS-232C connector																				
		<table border="1"> <thead> <tr> <th>No.</th> <th>Definition</th> </tr> </thead> <tbody> <tr> <td>1</td> <td>VBUS 5V</td> </tr> <tr> <td>2</td> <td>TXD</td> </tr> <tr> <td>3</td> <td>RXD</td> </tr> <tr> <td>4</td> <td>CTS</td> </tr> <tr> <td>5</td> <td>GND</td> </tr> <tr> <td>6</td> <td>RTS</td> </tr> <tr> <td>7</td> <td>NC</td> </tr> <tr> <td>8</td> <td>RTS</td> </tr> <tr> <td>9</td> <td>NC</td> </tr> </tbody> </table>	No.	Definition	1	VBUS 5V	2	TXD	3	RXD	4	CTS	5	GND	6	RTS	7	NC	8	RTS	9
No.	Definition																				
1	VBUS 5V																				
2	TXD																				
3	RXD																				
4	CTS																				
5	GND																				
6	RTS																				
7	NC																				
8	RTS																				
9	NC																				

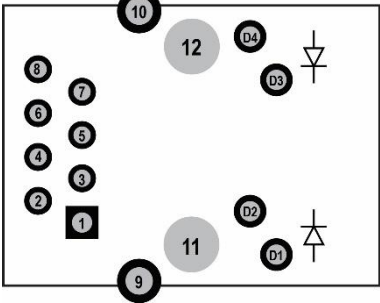
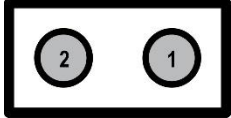
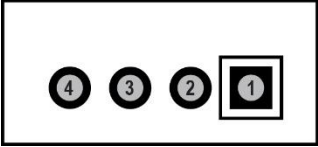
No.	Function	Pin Definition																										
6	Ethernet connector 	<table border="1"> <thead> <tr> <th>No.</th> <th>Definition</th> </tr> </thead> <tbody> <tr><td>1</td><td>TX+</td></tr> <tr><td>2</td><td>TX-</td></tr> <tr><td>3</td><td>RX+</td></tr> <tr><td>4</td><td>NC</td></tr> <tr><td>5</td><td>NC</td></tr> <tr><td>6</td><td>RX-</td></tr> <tr><td>7</td><td>NC</td></tr> <tr><td>8</td><td>FGND</td></tr> <tr><td>D1</td><td>3.3V</td></tr> <tr><td>D2</td><td>Green LED Control</td></tr> <tr><td>D3</td><td>Yellow LED Control</td></tr> <tr><td>D4</td><td>3.3V</td></tr> </tbody> </table>	No.	Definition	1	TX+	2	TX-	3	RX+	4	NC	5	NC	6	RX-	7	NC	8	FGND	D1	3.3V	D2	Green LED Control	D3	Yellow LED Control	D4	3.3V
No.	Definition																											
1	TX+																											
2	TX-																											
3	RX+																											
4	NC																											
5	NC																											
6	RX-																											
7	NC																											
8	FGND																											
D1	3.3V																											
D2	Green LED Control																											
D3	Yellow LED Control																											
D4	3.3V																											
7	ESD cable connector 	<table border="1"> <thead> <tr> <th>No.</th> <th>Definition</th> </tr> </thead> <tbody> <tr><td>1</td><td>GND</td></tr> <tr><td>2</td><td>GND</td></tr> </tbody> </table>	No.	Definition	1	GND	2	GND																				
No.	Definition																											
1	GND																											
2	GND																											
8	Ribbon sensor connector 	<table border="1"> <thead> <tr> <th>No.</th> <th>Definition</th> </tr> </thead> <tbody> <tr><td>1</td><td>3.3V</td></tr> <tr><td>2</td><td>Ribbon sensor receiver</td></tr> <tr><td>3</td><td>GND</td></tr> <tr><td>4</td><td>GND</td></tr> </tbody> </table>	No.	Definition	1	3.3V	2	Ribbon sensor receiver	3	GND	4	GND																
No.	Definition																											
1	3.3V																											
2	Ribbon sensor receiver																											
3	GND																											
4	GND																											

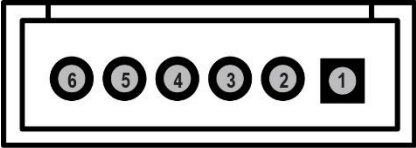
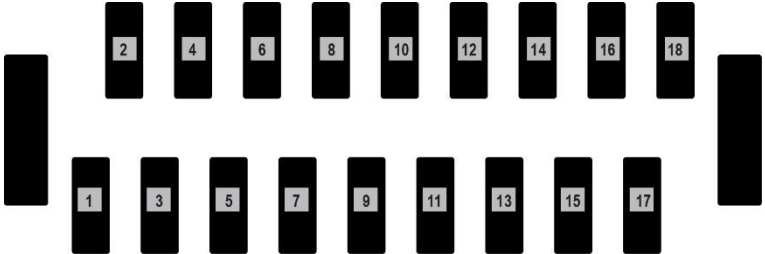
No.	Function	Pin Definition																																					
9	Panel touch and key connector																																						
		<table border="1"> <thead> <tr> <th>No.</th> <th>Definition</th> </tr> </thead> <tbody> <tr> <td>1</td> <td>3.3V</td> </tr> <tr> <td>2</td> <td>KEY_SDA</td> </tr> <tr> <td>3</td> <td>KEY_SCL</td> </tr> <tr> <td>4</td> <td>KEY_INT</td> </tr> <tr> <td>5</td> <td>GND</td> </tr> <tr> <td>6</td> <td>TOUCH_INT</td> </tr> </tbody> </table>	No.	Definition	1	3.3V	2	KEY_SDA	3	KEY_SCL	4	KEY_INT	5	GND	6	TOUCH_INT																							
No.	Definition																																						
1	3.3V																																						
2	KEY_SDA																																						
3	KEY_SCL																																						
4	KEY_INT																																						
5	GND																																						
6	TOUCH_INT																																						
10	LCD connector																																						
		<table border="1"> <thead> <tr> <th>No.</th> <th>Definition</th> </tr> </thead> <tbody> <tr> <td>1</td> <td>3.3V</td> </tr> <tr> <td>2</td> <td>3.3V</td> </tr> <tr> <td>3</td> <td>GND</td> </tr> <tr> <td>4</td> <td>3.3V</td> </tr> <tr> <td>5</td> <td>LCD_BL</td> </tr> <tr> <td>6</td> <td>LCD_D/CX</td> </tr> <tr> <td>7</td> <td>LCD_D0</td> </tr> <tr> <td>8</td> <td>LCD_D1</td> </tr> <tr> <td>9</td> <td>LCD_D2</td> </tr> <tr> <td>10</td> <td>LCD_D3</td> </tr> <tr> <td>11</td> <td>LCD_D4</td> </tr> <tr> <td>12</td> <td>LCD_D5</td> </tr> <tr> <td>13</td> <td>LCD_D6</td> </tr> <tr> <td>14</td> <td>LCD_D7</td> </tr> <tr> <td>15</td> <td>LCD_NCS</td> </tr> <tr> <td>16</td> <td>LCD_RESET</td> </tr> <tr> <td>17</td> <td>LCD_WE</td> </tr> <tr> <td>18</td> <td>GND</td> </tr> </tbody> </table>	No.	Definition	1	3.3V	2	3.3V	3	GND	4	3.3V	5	LCD_BL	6	LCD_D/CX	7	LCD_D0	8	LCD_D1	9	LCD_D2	10	LCD_D3	11	LCD_D4	12	LCD_D5	13	LCD_D6	14	LCD_D7	15	LCD_NCS	16	LCD_RESET	17	LCD_WE	18
No.	Definition																																						
1	3.3V																																						
2	3.3V																																						
3	GND																																						
4	3.3V																																						
5	LCD_BL																																						
6	LCD_D/CX																																						
7	LCD_D0																																						
8	LCD_D1																																						
9	LCD_D2																																						
10	LCD_D3																																						
11	LCD_D4																																						
12	LCD_D5																																						
13	LCD_D6																																						
14	LCD_D7																																						
15	LCD_NCS																																						
16	LCD_RESET																																						
17	LCD_WE																																						
18	GND																																						

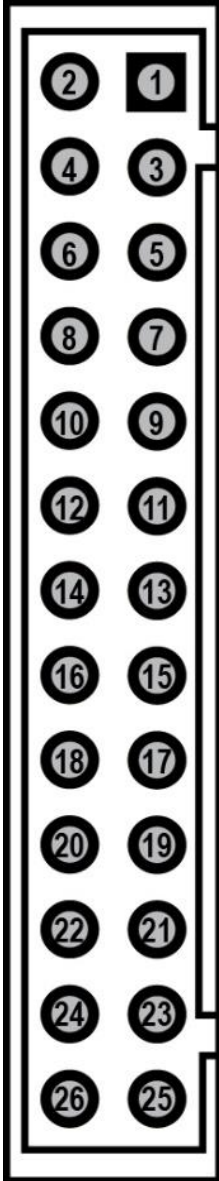
No.	Function	Pin Definition																																																					
11	TPH connector																																																						
		<table border="1"> <thead> <tr> <th data-bbox="1218 325 1368 363">No.</th> <th data-bbox="1368 325 1899 363">Definition</th> </tr> </thead> <tbody> <tr><td>1</td><td>TPH 24V</td></tr> <tr><td>2</td><td>TPH 24V</td></tr> <tr><td>3</td><td>TPH 24V</td></tr> <tr><td>4</td><td>TPH 24V</td></tr> <tr><td>5</td><td>GND</td></tr> <tr><td>6</td><td>GND</td></tr> <tr><td>7</td><td>Strobe2</td></tr> <tr><td>8</td><td>Data2</td></tr> <tr><td>9</td><td>TPH ID</td></tr> <tr><td>10</td><td>Temperature sensor</td></tr> <tr><td>11</td><td>5V</td></tr> <tr><td>12</td><td>GND</td></tr> <tr><td>13</td><td>Strobe1</td></tr> <tr><td>14</td><td>GND</td></tr> <tr><td>15</td><td>Clock</td></tr> <tr><td>16</td><td>GND</td></tr> <tr><td>17</td><td>GND</td></tr> <tr><td>18</td><td>GND</td></tr> <tr><td>19</td><td>Data1</td></tr> <tr><td>20</td><td>Latch</td></tr> <tr><td>21</td><td>GND</td></tr> <tr><td>22</td><td>GND</td></tr> <tr><td>23</td><td>TPH 24V</td></tr> <tr><td>24</td><td>TPH 24V</td></tr> <tr><td>25</td><td>TPH 24V</td></tr> <tr><td>26</td><td>TPH 24V</td></tr> </tbody> </table>	No.	Definition	1	TPH 24V	2	TPH 24V	3	TPH 24V	4	TPH 24V	5	GND	6	GND	7	Strobe2	8	Data2	9	TPH ID	10	Temperature sensor	11	5V	12	GND	13	Strobe1	14	GND	15	Clock	16	GND	17	GND	18	GND	19	Data1	20	Latch	21	GND	22	GND	23	TPH 24V	24	TPH 24V	25	TPH 24V	26
No.	Definition																																																						
1	TPH 24V																																																						
2	TPH 24V																																																						
3	TPH 24V																																																						
4	TPH 24V																																																						
5	GND																																																						
6	GND																																																						
7	Strobe2																																																						
8	Data2																																																						
9	TPH ID																																																						
10	Temperature sensor																																																						
11	5V																																																						
12	GND																																																						
13	Strobe1																																																						
14	GND																																																						
15	Clock																																																						
16	GND																																																						
17	GND																																																						
18	GND																																																						
19	Data1																																																						
20	Latch																																																						
21	GND																																																						
22	GND																																																						
23	TPH 24V																																																						
24	TPH 24V																																																						
25	TPH 24V																																																						
26	TPH 24V																																																						

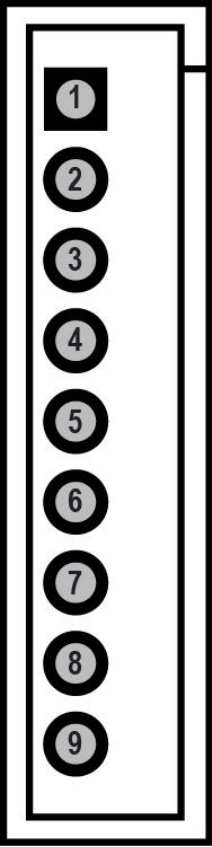
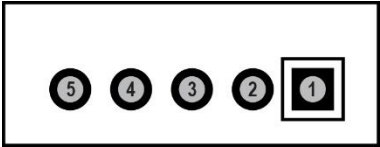
No.	Function	Pin Definition																				
12	Micro SD card connector 	<table border="1"> <thead> <tr> <th>No.</th> <th>Definition</th> </tr> </thead> <tbody> <tr> <td>1</td> <td>Micro_SD_DATA1</td> </tr> <tr> <td>2</td> <td>Micro_SD_DATA0</td> </tr> <tr> <td>3</td> <td>GND</td> </tr> <tr> <td>4</td> <td>Micro_SD_CLK</td> </tr> <tr> <td>5</td> <td>3.3V</td> </tr> <tr> <td>6</td> <td>Micro_SD_CMD</td> </tr> <tr> <td>7</td> <td>Micro_SD_DATA3</td> </tr> <tr> <td>8</td> <td>Micro_SD_DATA2</td> </tr> <tr> <td>9</td> <td>Micro_SD_DT</td> </tr> </tbody> </table>	No.	Definition	1	Micro_SD_DATA1	2	Micro_SD_DATA0	3	GND	4	Micro_SD_CLK	5	3.3V	6	Micro_SD_CMD	7	Micro_SD_DATA3	8	Micro_SD_DATA2	9	Micro_SD_DT
No.	Definition																					
1	Micro_SD_DATA1																					
2	Micro_SD_DATA0																					
3	GND																					
4	Micro_SD_CLK																					
5	3.3V																					
6	Micro_SD_CMD																					
7	Micro_SD_DATA3																					
8	Micro_SD_DATA2																					
9	Micro_SD_DT																					
13	Ribbon end sensor connector 	<table border="1"> <thead> <tr> <th>No.</th> <th>Definition</th> </tr> </thead> <tbody> <tr> <td>1</td> <td>3.3V</td> </tr> <tr> <td>2</td> <td>KEY_SDA</td> </tr> <tr> <td>3</td> <td>KEY_SCL</td> </tr> <tr> <td>4</td> <td>KEY_INT</td> </tr> <tr> <td>5</td> <td>GND</td> </tr> </tbody> </table>	No.	Definition	1	3.3V	2	KEY_SDA	3	KEY_SCL	4	KEY_INT	5	GND								
No.	Definition																					
1	3.3V																					
2	KEY_SDA																					
3	KEY_SCL																					
4	KEY_INT																					
5	GND																					

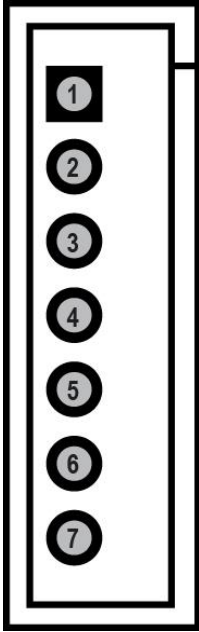
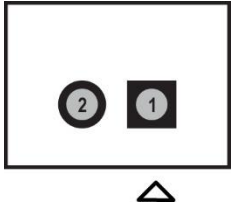
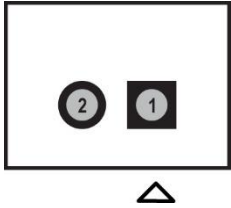
No.	Function	Pin Definition															
14	NFC / Ribbon cartridge connector																
		<table border="1"> <thead> <tr> <th>No.</th> <th>Definition</th> </tr> </thead> <tbody> <tr> <td>1</td> <td>3.3V</td> </tr> <tr> <td>2</td> <td>NFC_TWD</td> </tr> <tr> <td>3</td> <td>NFC_TWCK</td> </tr> <tr> <td>4</td> <td>GND</td> </tr> <tr> <td>5</td> <td>NFC_RTS</td> </tr> <tr> <td>6</td> <td>NFC_CTS</td> </tr> <tr> <td>7</td> <td>NFC_UPDATE</td> </tr> </tbody> </table>	No.	Definition	1	3.3V	2	NFC_TWD	3	NFC_TWCK	4	GND	5	NFC_RTS	6	NFC_CTS	7
No.	Definition																
1	3.3V																
2	NFC_TWD																
3	NFC_TWCK																
4	GND																
5	NFC_RTS																
6	NFC_CTS																
7	NFC_UPDATE																
15	Gap sensor connector (for transmit signals)																
		<table border="1"> <thead> <tr> <th>No.</th> <th>Definition</th> </tr> </thead> <tbody> <tr> <td>1</td> <td>3.3V</td> </tr> <tr> <td>2</td> <td>TH: Gap sensor emitter DH: Print side BM sensor emitter</td> </tr> </tbody> </table>	No.	Definition	1	3.3V	2	TH: Gap sensor emitter DH: Print side BM sensor emitter									
No.	Definition																
1	3.3V																
2	TH: Gap sensor emitter DH: Print side BM sensor emitter																
16	Gap sensor connector (for receive signals)																
		<table border="1"> <thead> <tr> <th>No.</th> <th>Definition</th> </tr> </thead> <tbody> <tr> <td>1</td> <td>TH: 3.3V DH: NC</td> </tr> <tr> <td>2</td> <td>TH: Gap sensor receiver DH: Print side BM sensor receiver</td> </tr> </tbody> </table>	No.	Definition	1	TH: 3.3V DH: NC	2	TH: Gap sensor receiver DH: Print side BM sensor receiver									
No.	Definition																
1	TH: 3.3V DH: NC																
2	TH: Gap sensor receiver DH: Print side BM sensor receiver																

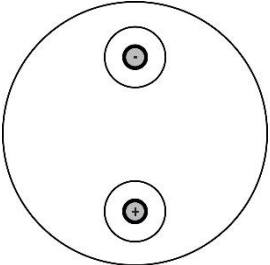
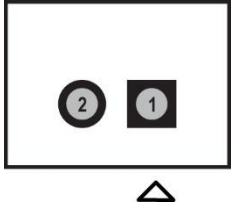
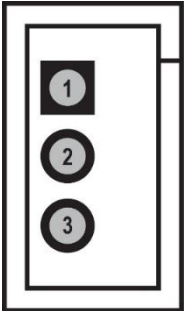
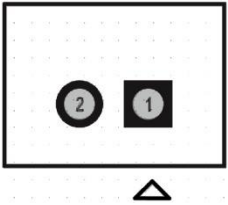
No.	Function	Pin Definition							
17	Buzzer								
		<table border="1"> <thead> <tr> <th>No.</th> <th>Definition</th> </tr> </thead> <tbody> <tr> <td>+</td> <td>SYS 24V</td> </tr> <tr> <td>-</td> <td>Buzzer control</td> </tr> </tbody> </table>	No.	Definition	+	SYS 24V	-	Buzzer control	
No.	Definition								
+	SYS 24V								
-	Buzzer control								
18	DC motor connector								
		<table border="1"> <thead> <tr> <th>No.</th> <th>Definition</th> </tr> </thead> <tbody> <tr> <td>1</td> <td>DC_MA</td> </tr> <tr> <td>2</td> <td>DC_MB</td> </tr> </tbody> </table>	No.	Definition	1	DC_MA	2	DC_MB	
No.	Definition								
1	DC_MA								
2	DC_MB								
19	Back side black mark sensor connector								
		<table border="1"> <thead> <tr> <th>No.</th> <th>Definition</th> </tr> </thead> <tbody> <tr> <td>1</td> <td>BM sensor receiver</td> </tr> <tr> <td>2</td> <td>BM sensor emitter</td> </tr> <tr> <td>3</td> <td>3.3V</td> </tr> </tbody> </table>	No.	Definition	1	BM sensor receiver	2	BM sensor emitter	3
No.	Definition								
1	BM sensor receiver								
2	BM sensor emitter								
3	3.3V								
20	Coin battery connector								
		<table border="1"> <thead> <tr> <th>No.</th> <th>Definition</th> </tr> </thead> <tbody> <tr> <td>1</td> <td>Vbattery</td> </tr> <tr> <td>2</td> <td>GND</td> </tr> </tbody> </table>	No.	Definition	1	Vbattery	2	GND	
No.	Definition								
1	Vbattery								
2	GND								

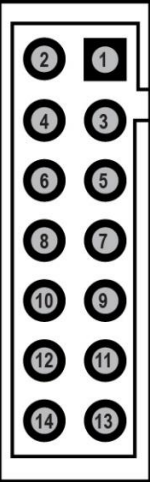
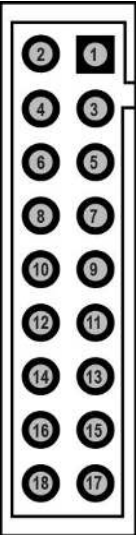
No.	Function	Pin Definition																																					
21	Cutter / Peeler / RFID connector																																						
		<table border="1"> <thead> <tr> <th>No.</th> <th>Definition</th> </tr> </thead> <tbody> <tr><td>1</td><td>CRFID_RXD</td></tr> <tr><td>2</td><td>CRFID_TXD</td></tr> <tr><td>3</td><td>5V_RFID</td></tr> <tr><td>4</td><td>GND</td></tr> <tr><td>5</td><td>Peeler_TWD</td></tr> <tr><td>6</td><td>Peeler sensor receiver</td></tr> <tr><td>7</td><td>5V_Cutter</td></tr> <tr><td>8</td><td>Peeler_TWCK</td></tr> <tr><td>9</td><td>Cutter rotate direction</td></tr> <tr><td>10</td><td>Cutter enable signal</td></tr> <tr><td>11</td><td>GND</td></tr> <tr><td>12</td><td>Cutter status</td></tr> <tr><td>13</td><td>GND</td></tr> <tr><td>14</td><td>24V</td></tr> </tbody> </table>	No.	Definition	1	CRFID_RXD	2	CRFID_TXD	3	5V_RFID	4	GND	5	Peeler_TWD	6	Peeler sensor receiver	7	5V_Cutter	8	Peeler_TWCK	9	Cutter rotate direction	10	Cutter enable signal	11	GND	12	Cutter status	13	GND	14	24V							
No.	Definition																																						
1	CRFID_RXD																																						
2	CRFID_TXD																																						
3	5V_RFID																																						
4	GND																																						
5	Peeler_TWD																																						
6	Peeler sensor receiver																																						
7	5V_Cutter																																						
8	Peeler_TWCK																																						
9	Cutter rotate direction																																						
10	Cutter enable signal																																						
11	GND																																						
12	Cutter status																																						
13	GND																																						
14	24V																																						
22	Wi-Fi & Bluetooth connector																																						
		<table border="1"> <thead> <tr> <th>No.</th> <th>Definition</th> </tr> </thead> <tbody> <tr><td>1</td><td>GND</td></tr> <tr><td>2</td><td>3.3V_WIFI</td></tr> <tr><td>3</td><td>WIFI/BT_Detect</td></tr> <tr><td>4</td><td>WIFI_RX0</td></tr> <tr><td>5</td><td>WIFI_RX1</td></tr> <tr><td>6</td><td>WIFI_RXDV</td></tr> <tr><td>7</td><td>WIFI_REFCK</td></tr> <tr><td>8</td><td>GND</td></tr> <tr><td>9</td><td>WIFI_WAKEUP</td></tr> <tr><td>10</td><td>WIFI_TXEN</td></tr> <tr><td>11</td><td>WIFI_TX0</td></tr> <tr><td>12</td><td>WIFI_TX1</td></tr> <tr><td>13</td><td>BT_TXD</td></tr> <tr><td>14</td><td>BT_CTS</td></tr> <tr><td>15</td><td>BT_RXD</td></tr> <tr><td>16</td><td>BT_RTS</td></tr> <tr><td>17</td><td>3.3V_WIFI</td></tr> <tr><td>18</td><td>WIFI_RESET</td></tr> </tbody> </table>	No.	Definition	1	GND	2	3.3V_WIFI	3	WIFI/BT_Detect	4	WIFI_RX0	5	WIFI_RX1	6	WIFI_RXDV	7	WIFI_REFCK	8	GND	9	WIFI_WAKEUP	10	WIFI_TXEN	11	WIFI_TX0	12	WIFI_TX1	13	BT_TXD	14	BT_CTS	15	BT_RXD	16	BT_RTS	17	3.3V_WIFI	18
No.	Definition																																						
1	GND																																						
2	3.3V_WIFI																																						
3	WIFI/BT_Detect																																						
4	WIFI_RX0																																						
5	WIFI_RX1																																						
6	WIFI_RXDV																																						
7	WIFI_REFCK																																						
8	GND																																						
9	WIFI_WAKEUP																																						
10	WIFI_TXEN																																						
11	WIFI_TX0																																						
12	WIFI_TX1																																						
13	BT_TXD																																						
14	BT_CTS																																						
15	BT_RXD																																						
16	BT_RTS																																						
17	3.3V_WIFI																																						
18	WIFI_RESET																																						

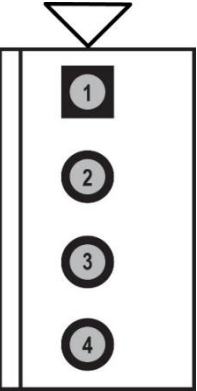
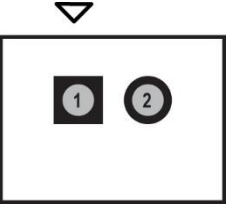
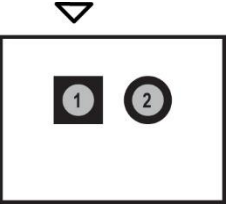
No.	Function	Pin Definition										
23	Motor connector 	<table border="1"> <thead> <tr> <th>Pin No.</th> <th>Definition</th> </tr> </thead> <tbody> <tr> <td>1</td> <td>BOUT2</td> </tr> <tr> <td>2</td> <td>BOUT1</td> </tr> <tr> <td>3</td> <td>AOUT1</td> </tr> <tr> <td>4</td> <td>AOUT2</td> </tr> </tbody> </table>	Pin No.	Definition	1	BOUT2	2	BOUT1	3	AOUT1	4	AOUT2
Pin No.	Definition											
1	BOUT2											
2	BOUT1											
3	AOUT1											
4	AOUT2											
24	Head open connector 	<table border="1"> <thead> <tr> <th>Pin No.</th> <th>Definition</th> </tr> </thead> <tbody> <tr> <td>1</td> <td>Head open sensor (receiver)</td> </tr> <tr> <td>2</td> <td>GND</td> </tr> </tbody> </table>	Pin No.	Definition	1	Head open sensor (receiver)	2	GND				
Pin No.	Definition											
1	Head open sensor (receiver)											
2	GND											
25	Power switch connector 	<table border="1"> <thead> <tr> <th>Pin No.</th> <th>Definition</th> </tr> </thead> <tbody> <tr> <td>1</td> <td>EN_24V</td> </tr> <tr> <td>2</td> <td>SW_24V</td> </tr> </tbody> </table>	Pin No.	Definition	1	EN_24V	2	SW_24V				
Pin No.	Definition											
1	EN_24V											
2	SW_24V											

2.2 Interface Pin Configuration

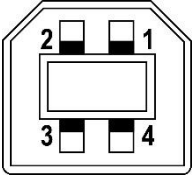
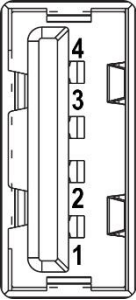
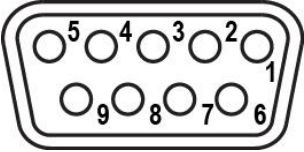
No.	Function	Pin Configuration																			
1	USB device																				
		<table border="1"> <thead> <tr> <th>No.</th> <th>Configuration</th> </tr> </thead> <tbody> <tr> <td>1</td> <td>NC</td> </tr> <tr> <td>2</td> <td>D-</td> </tr> <tr> <td>3</td> <td>D+</td> </tr> <tr> <td>4</td> <td>GND</td> </tr> </tbody> </table>	No.	Configuration	1	NC	2	D-	3	D+	4	GND									
No.	Configuration																				
1	NC																				
2	D-																				
3	D+																				
4	GND																				
2	USB host																				
		<table border="1"> <thead> <tr> <th>No.</th> <th>Configuration</th> </tr> </thead> <tbody> <tr> <td>1</td> <td>5V</td> </tr> <tr> <td>2</td> <td>D-</td> </tr> <tr> <td>3</td> <td>D+</td> </tr> <tr> <td>4</td> <td>GND</td> </tr> </tbody> </table>	No.	Configuration	1	5V	2	D-	3	D+	4	GND									
No.	Configuration																				
1	5V																				
2	D-																				
3	D+																				
4	GND																				
3	RS-232C																				
		<table border="1"> <thead> <tr> <th>No.</th> <th>Configuration</th> </tr> </thead> <tbody> <tr> <td>1</td> <td>+5V</td> </tr> <tr> <td>2</td> <td>TXD</td> </tr> <tr> <td>3</td> <td>RXD</td> </tr> <tr> <td>4</td> <td>CTS</td> </tr> <tr> <td>5</td> <td>GND</td> </tr> <tr> <td>6</td> <td>RTS</td> </tr> <tr> <td>7</td> <td>NC</td> </tr> <tr> <td>8</td> <td>RTS</td> </tr> <tr> <td>9</td> <td>NC</td> </tr> </tbody> </table>	No.	Configuration	1	+5V	2	TXD	3	RXD	4	CTS	5	GND	6	RTS	7	NC	8	RTS	9
No.	Configuration																				
1	+5V																				
2	TXD																				
3	RXD																				
4	CTS																				
5	GND																				
6	RTS																				
7	NC																				
8	RTS																				
9	NC																				

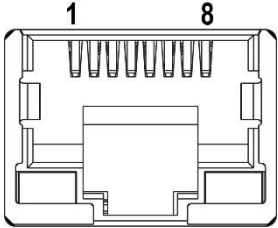
No.	Function	Pin Configuration																		
4	Ethernet LAN port 	<table border="1"> <thead> <tr> <th data-bbox="1218 279 1368 320">No.</th> <th data-bbox="1368 279 1899 320">Definition</th> </tr> </thead> <tbody> <tr> <td data-bbox="1218 320 1368 362">1</td> <td data-bbox="1368 320 1899 362">Tx+</td> </tr> <tr> <td data-bbox="1218 362 1368 403">2</td> <td data-bbox="1368 362 1899 403">Tx-</td> </tr> <tr> <td data-bbox="1218 403 1368 445">3</td> <td data-bbox="1368 403 1899 445">Rx+</td> </tr> <tr> <td data-bbox="1218 445 1368 486">4</td> <td data-bbox="1368 445 1899 486">NC</td> </tr> <tr> <td data-bbox="1218 486 1368 528">5</td> <td data-bbox="1368 486 1899 528">NC</td> </tr> <tr> <td data-bbox="1218 528 1368 569">6</td> <td data-bbox="1368 528 1899 569">Rx-</td> </tr> <tr> <td data-bbox="1218 569 1368 611">7</td> <td data-bbox="1368 569 1899 611">NC</td> </tr> <tr> <td data-bbox="1218 611 1368 652">8</td> <td data-bbox="1368 611 1899 652">NC</td> </tr> </tbody> </table>	No.	Definition	1	Tx+	2	Tx-	3	Rx+	4	NC	5	NC	6	Rx-	7	NC	8	NC
No.	Definition																			
1	Tx+																			
2	Tx-																			
3	Rx+																			
4	NC																			
5	NC																			
6	Rx-																			
7	NC																			
8	NC																			

3 Replacing Parts

3.1 Before You Begin

WARNING:

To avoid the risk of personal injury from electrical shock, before performing any replacement procedures, unplug the power cord from the printer or power outlet to ensure that power is removed.

To prepare the printer for the replacement or installation:

1. Protect yourself from ESD and wear protective gloves.
2. Place the printer on a flat surface.
3. Set the printer's power switch to the O (Off) position.
4. Remove the power adapter from the printer or unplug the power cord from the AC power outlet.
5. Disconnect all interface cables from the rear panel of the printer.
6. Remove the media and ribbon from the printer.
7. Read through the maintenance procedures.

3.2 Replacing the Platen Roller Assembly

1. Follow the steps in [Before You Begin](#) to prepare the printer.
2. Open the printer cover by pulling the green levers, located on each side, toward the front of the printer, then lift the printer cover.
3. Remove the lower front panel as shown.



4. Disengage the platen roller by pulling out the tabs located on each side. Press the tabs to rotate them into the upward position as shown.



5. Pulling upward to remove/ replace the platen roller assembly.

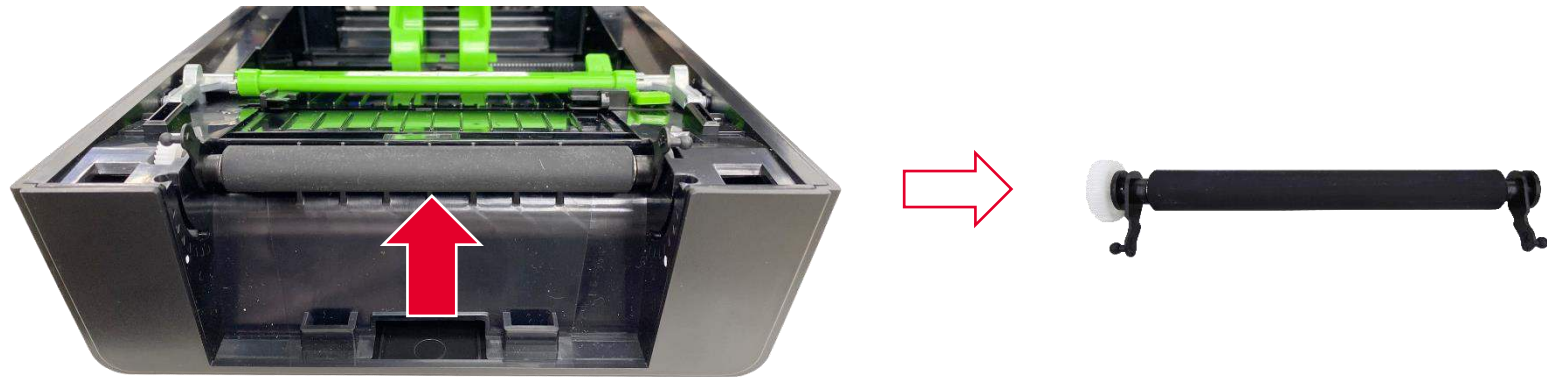

6. Reassemble the parts in the reverse procedure.

Note:

The default position of the platen roller tab is shown below (with a mark).

Default setting

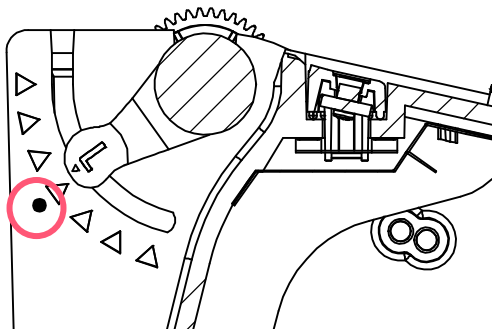

3.3 Replacing the Printhead Assembly

CAUTION:

To prevent electrostatic damage to electronic components, ground yourself by touching an unpainted part of the printer frame before removing or installing the printhead assembly.

1. Follow the steps in [Before You Begin](#) to prepare the printer.
2. Open the printer cover by pulling the green levers, located on each side, toward the front of the printer, then lift the printer cover.
3. Open the ribbon access cover.
4. Push the one side of print head assembly then lift up to disengage it from inner cover.

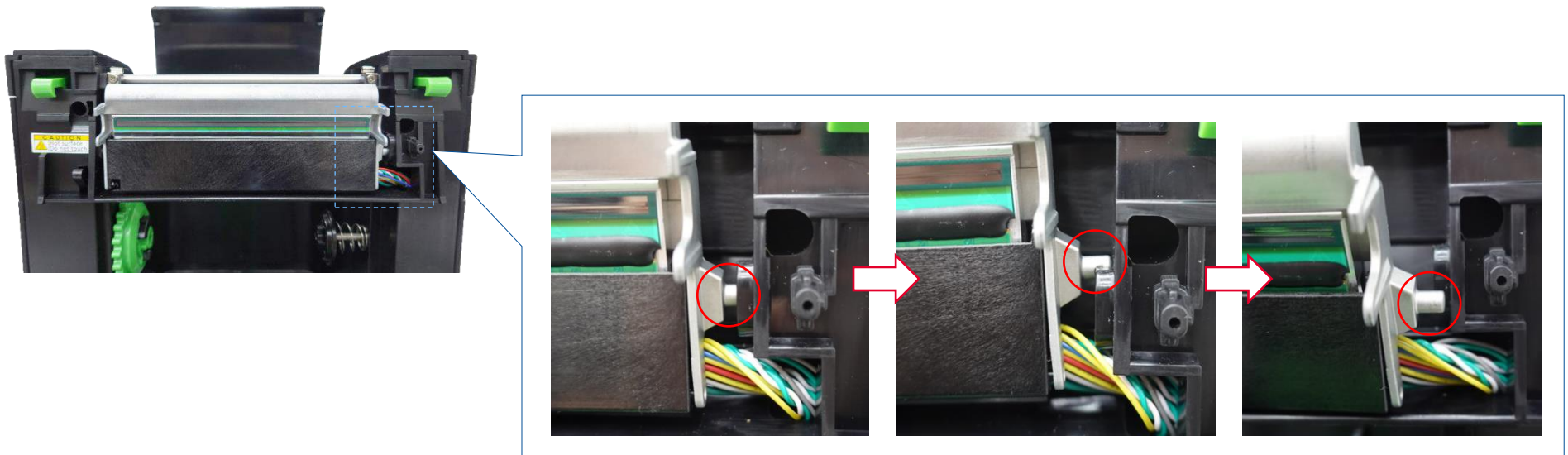

5. Push and release the print head bracket hooks as indicated to remove the print head bracket (black).

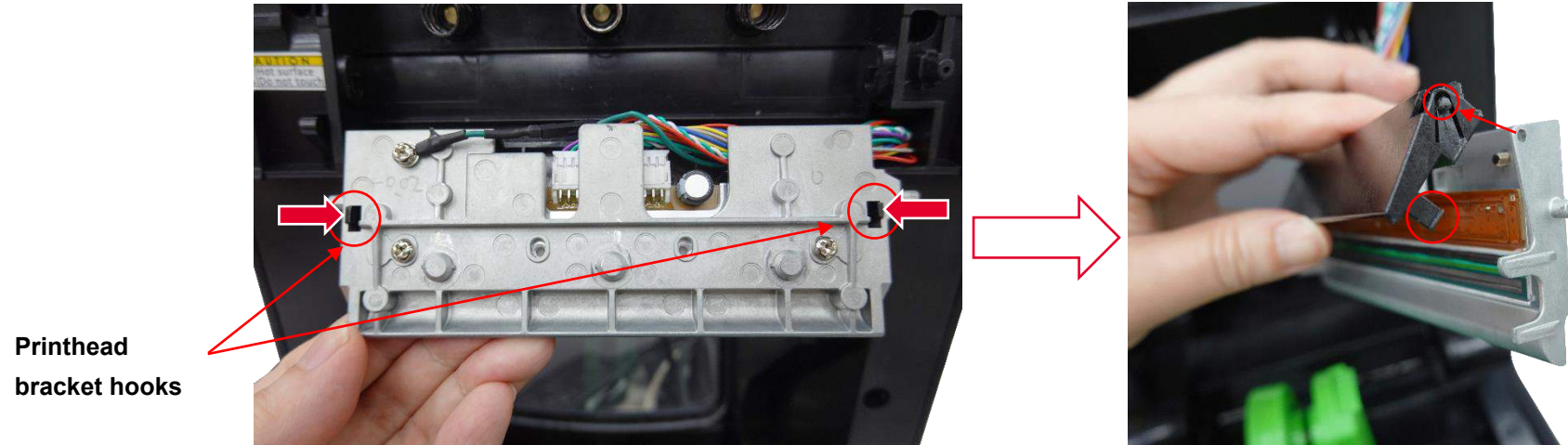

6. Disconnect the ground wire (green cable) and printhead harness. Remove/ Replace the printhead assembly.

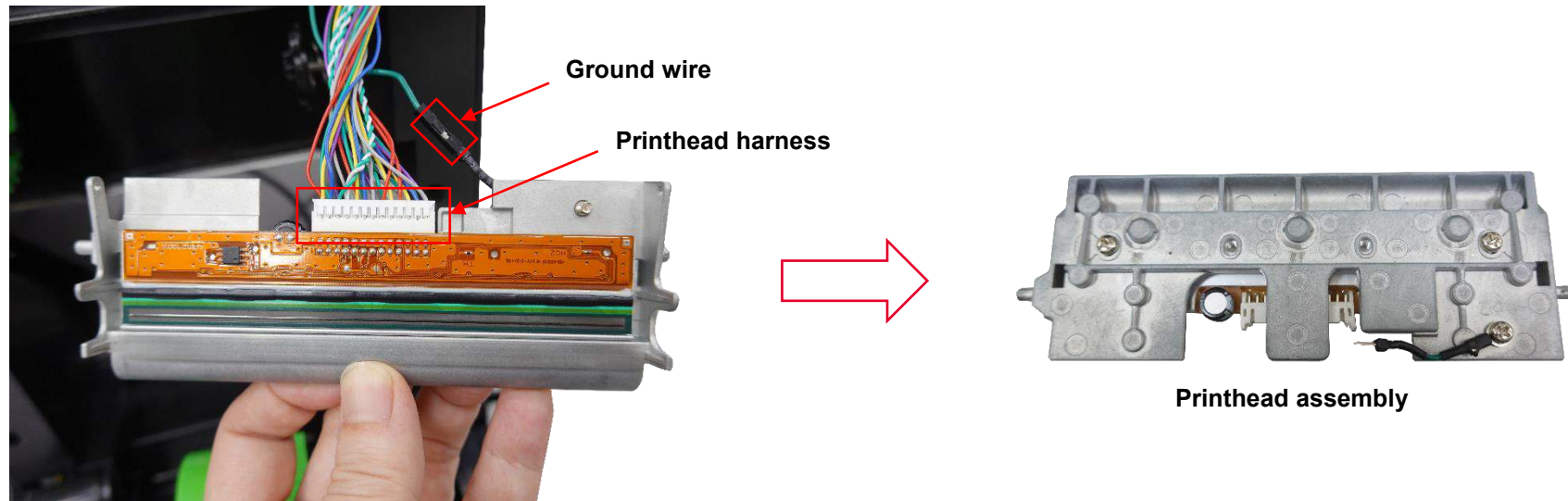

CAUTION:

Oils from your hands can damage the light brown area (heating elements) of the printhead. Do not touch the light brown area when you handle the printhead assembly.

7. Reassemble the parts in the reverse procedures.

Note:

- **When installing the print head bracket, make sure the printhead cable assemblies are inside the bracket.**

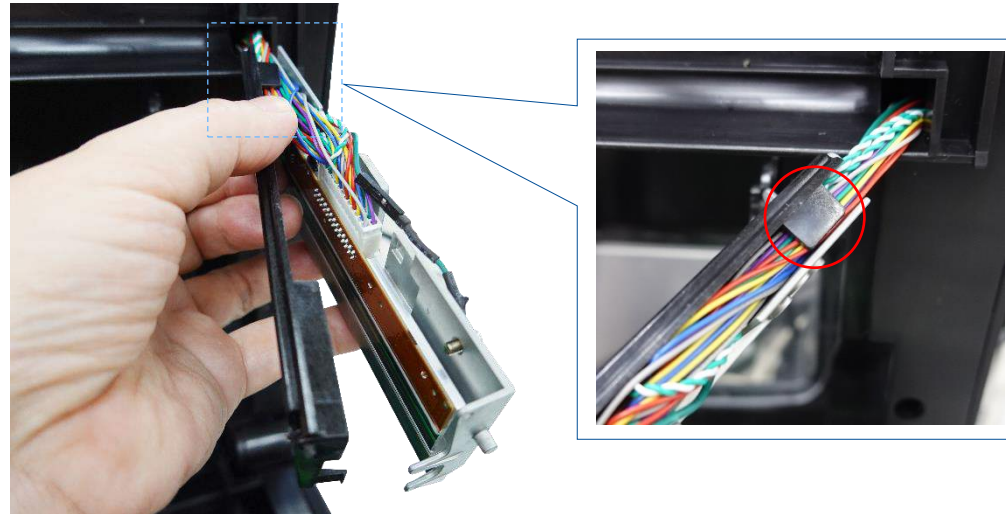

- **When installing the print head assembly, make sure the three springs are in the correct position. If necessary, you can increase the printhead pressure by rotating the spring.**

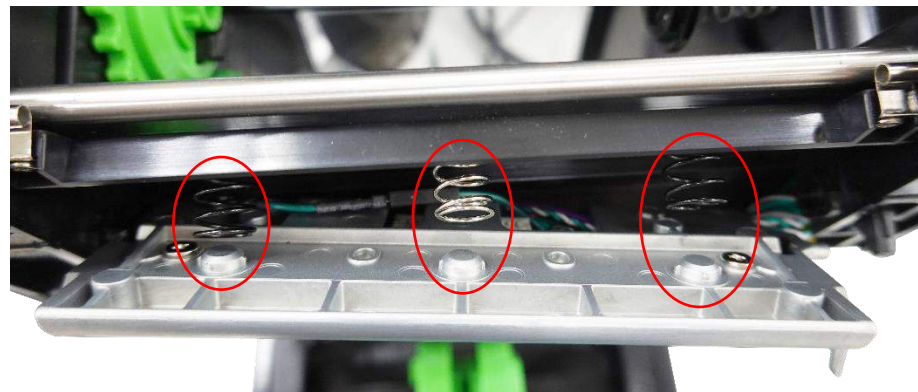

3.4 Replacing the Top Cover

1. Follow the steps in [Before You Begin](#) to prepare the printer.
2. Open the printer cover by pulling the green levers, located on each side, toward the front of the printer, then lift the printer cover.
3. Remove six screws on the printer top inner cover as shown below. Open the ribbon access cover to remove/replace the printer top cover. Reassemble the parts in the reverse procedures.

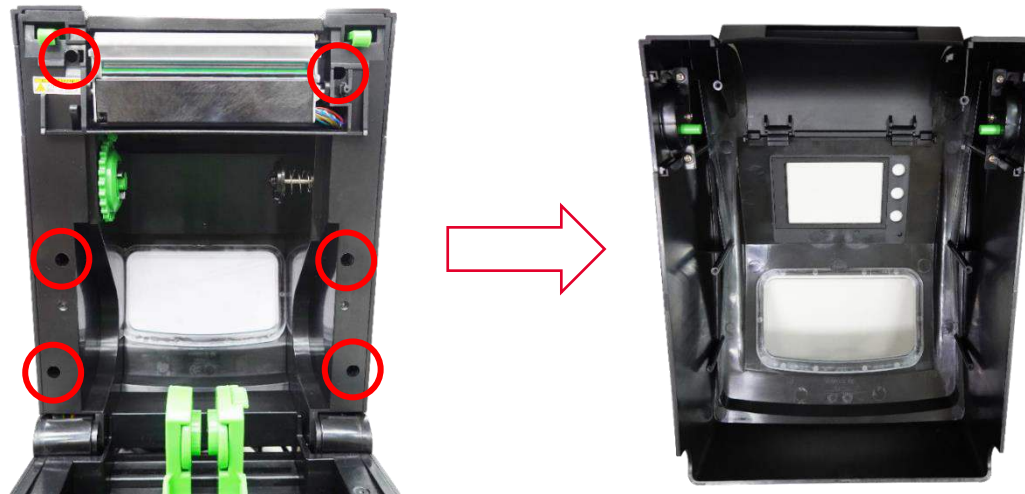

Note:

If your printer is equipped with a wireless module (Wi-Fi or Bluetooth) with LED version, please note that the NFC tag should be installed back into the LED top cover. (For LCD version, the NFC tag is in the LCD module bracket.)

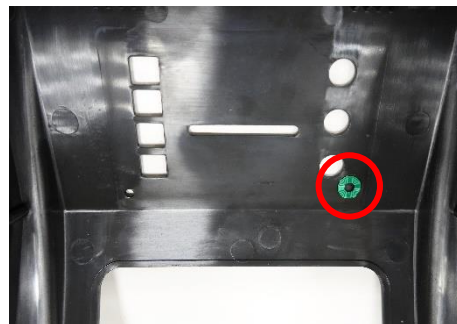

3.5 Replacing the Control Panel Assembly

1. Follow the steps in [Before You Begin](#) to prepare the printer.
2. Refer to [Replacing the Top Cover](#) to remove the printer top cover.
3. For LCD version (For LED version, go to the next step), remove two screws on LCD bracket and one connector as shown below.

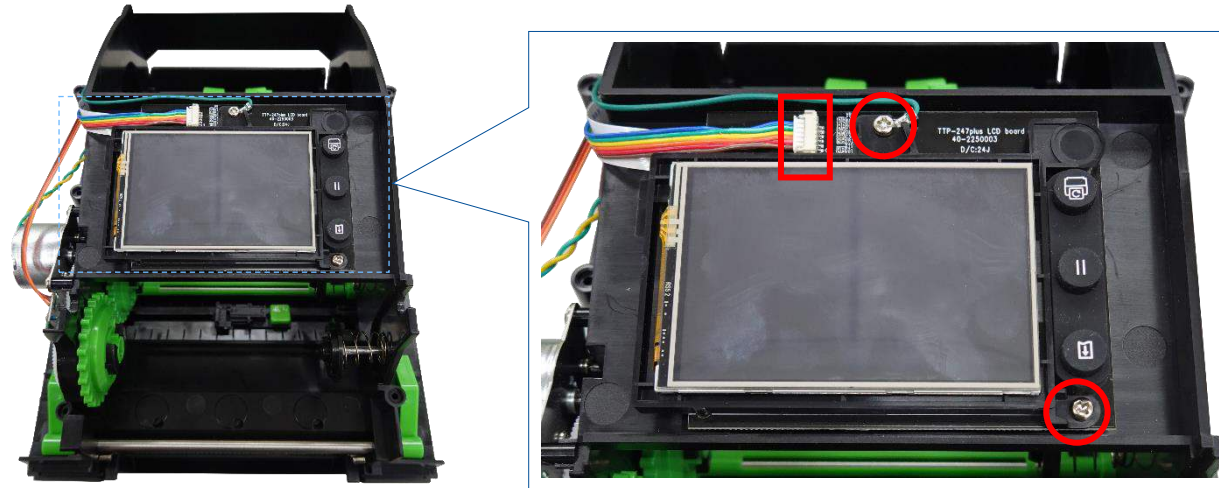

Disconnect two flat cables on back of LCD control panel board. For flat cable, press the plug(s) to unlock it from connector on the control panel board, and carefully pull the flat cable free (do not pull on the wires; pull on the plug only).

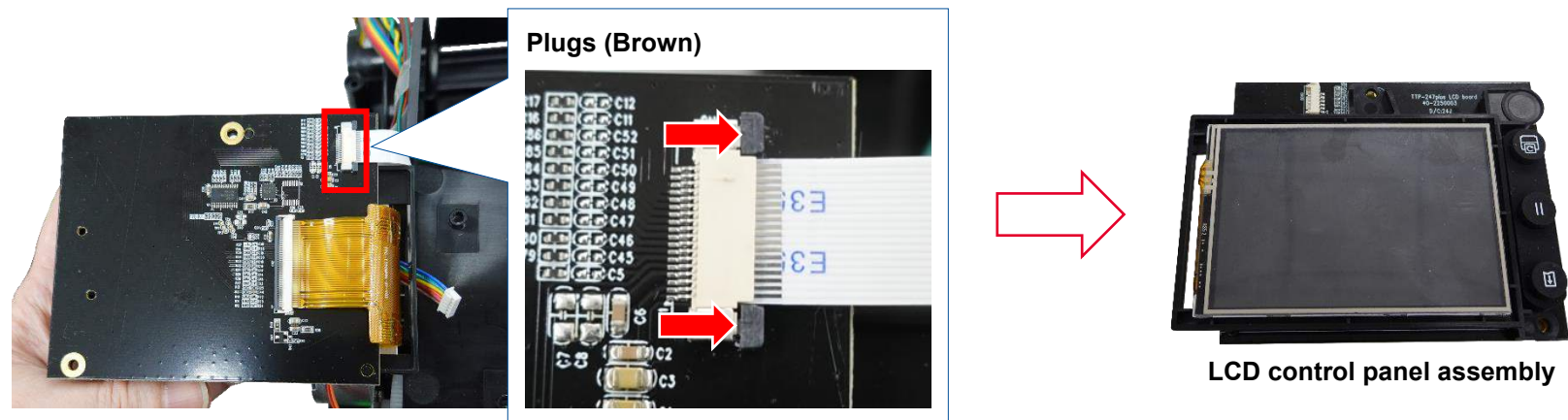

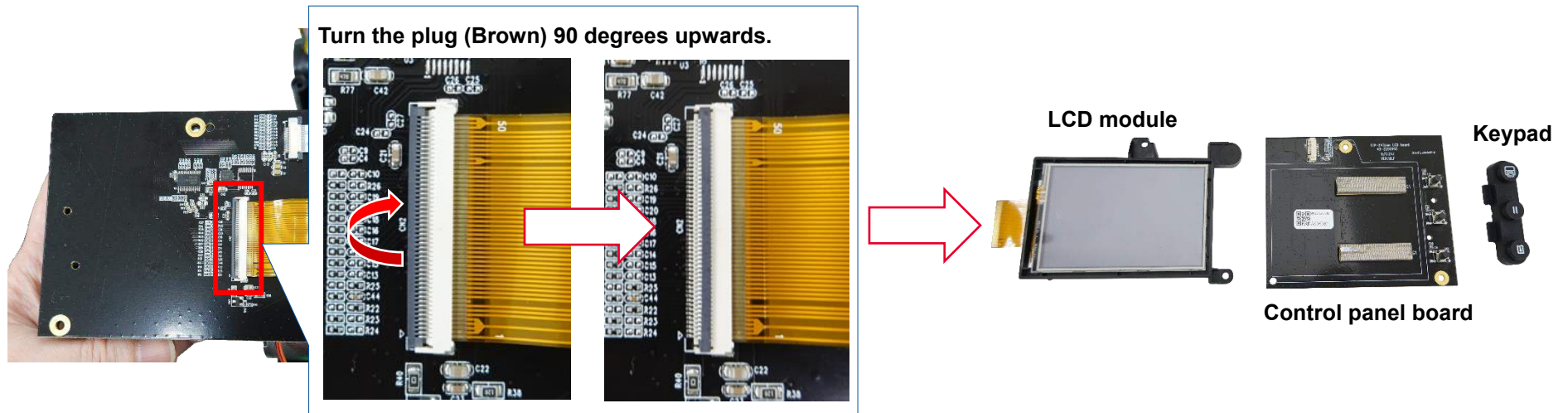

Note:

- ◆ When installing the control panel assembly, the ground cable must be secured underneath the control panel bracket.



- ◆ If your printer is equipped with a wireless module (Wi-Fi or Bluetooth), please note that the NFC tag should be installed back into the LCD module bracket.



4. For LED version, remove three screws and one connector on LED board as shown below. Remove two screws on back of LED board to replace the LED bar and the keypad.

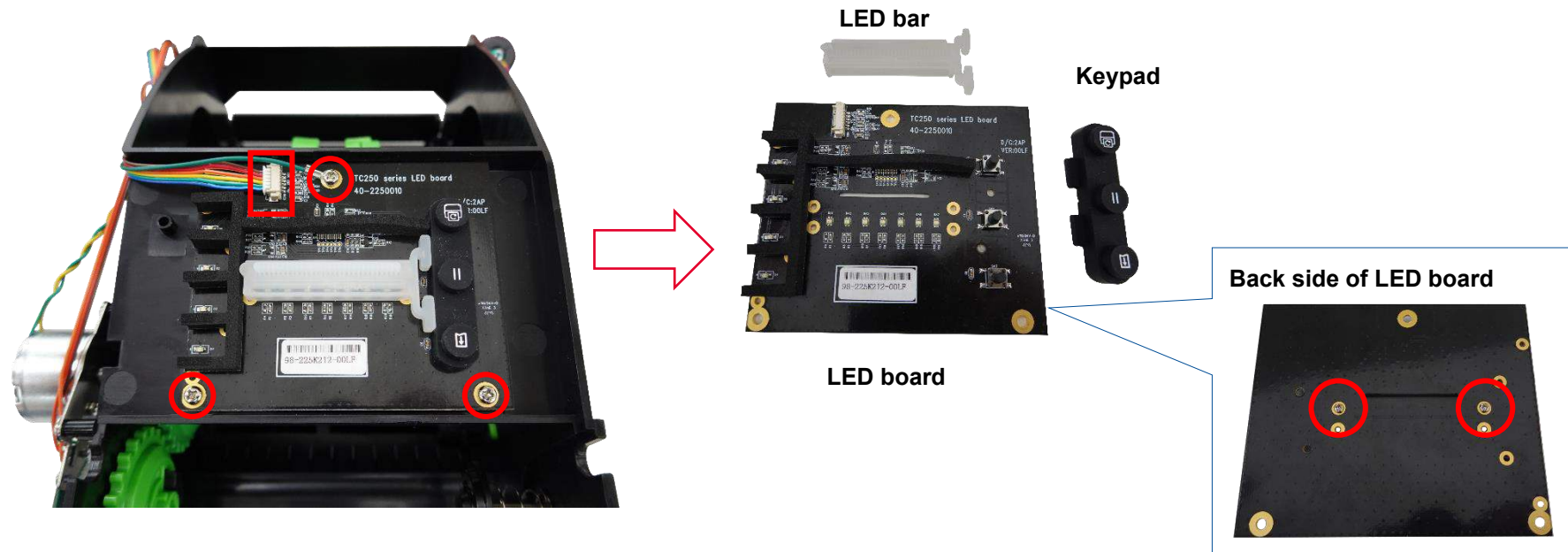

5. Reassemble the parts in the reverse procedures.

3.6 Replacing the Lower Cover

1. Follow the steps in [Before You Begin](#) to prepare the printer.
2. Remove two screws on the rear of printer to remove the interface cover.



3. Put the printer upside down. Remove one screw on the RTC cover to disconnect two cables from main board first. (disconnect the Wi-Fi or bluetooth cable if installed) Remove the cover.

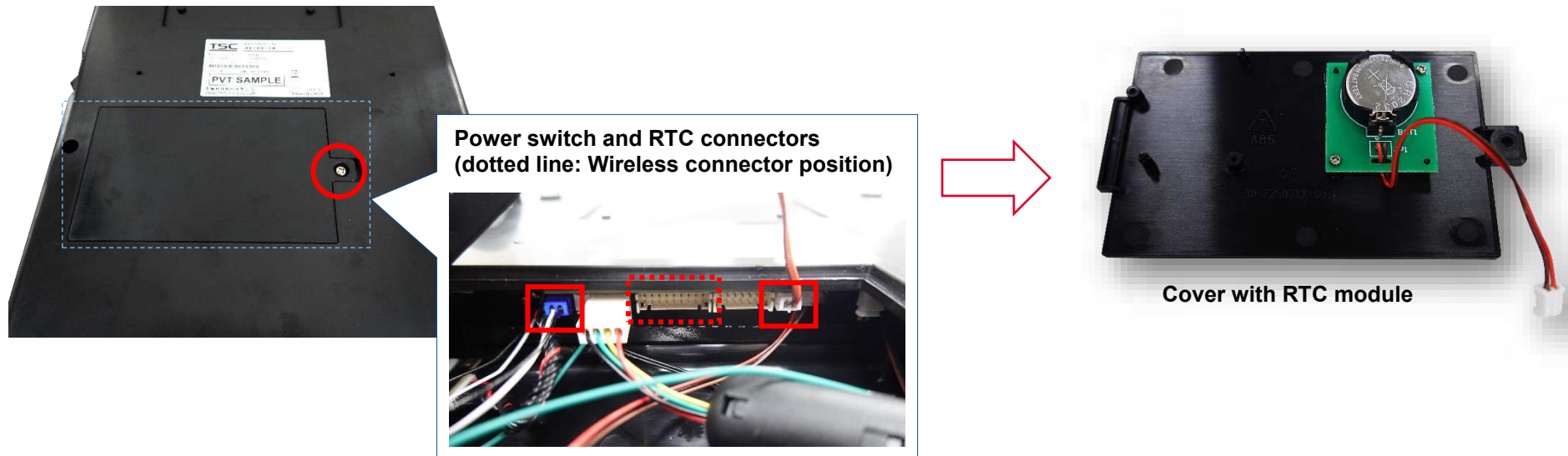

4. Remove six screws on the printer lower cover.



5. Reassemble the parts in the reverse procedures.

3.7 Replacing the RTC Module

1. Follow the steps in [Before You Begin](#) to prepare the printer.
2. Put the printer upside down. Remove one screw on the RTC module to disconnect the RTC cable from main board.

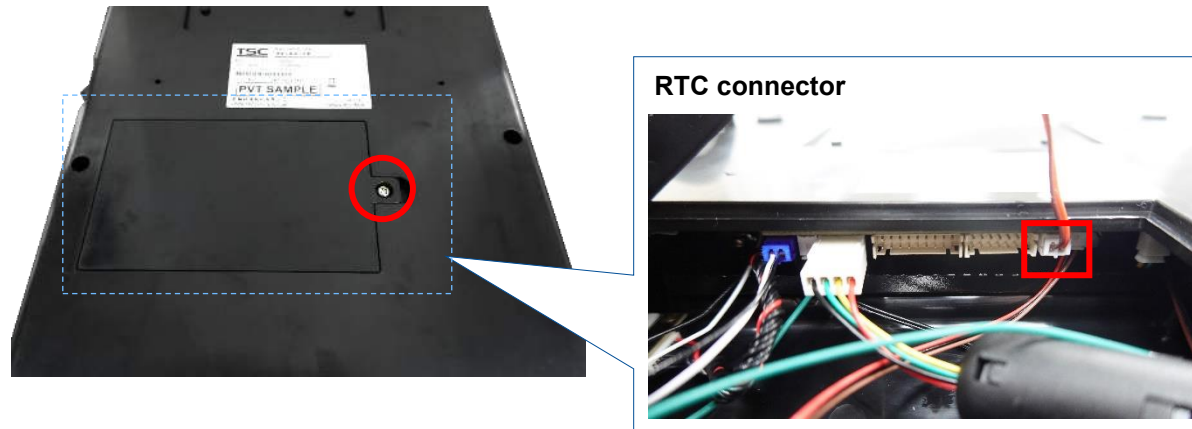

3. Remove/ Replace the RTC module. Please note that RTC battery (CR2032) is not included in the RTC module kit. Reassemble the parts in the reverse procedures.



Note:

Press the tab to release the battery in the direction shown in the figure below.

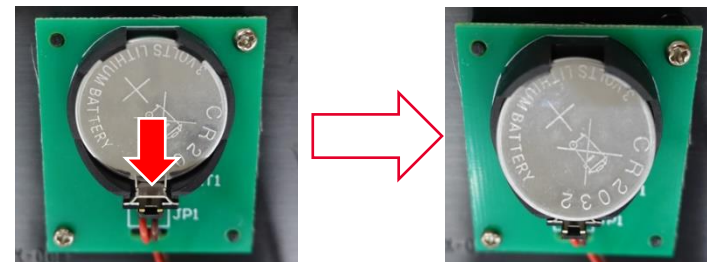

3.8 Replacing the Main Board

1. Follow the steps in [Before You Begin](#) to prepare the printer.
2. Refer to [Replacing the Lower Cover](#) to remove the printer lower cover.

CAUTION

To prevent electrostatic damage to electronic components, always wear a properly grounded static wrist strap when you handle circuit boards.

3. Remove four screws on main board. Unplug all cable assemblies from the main board. Remove/ Replace the main board.

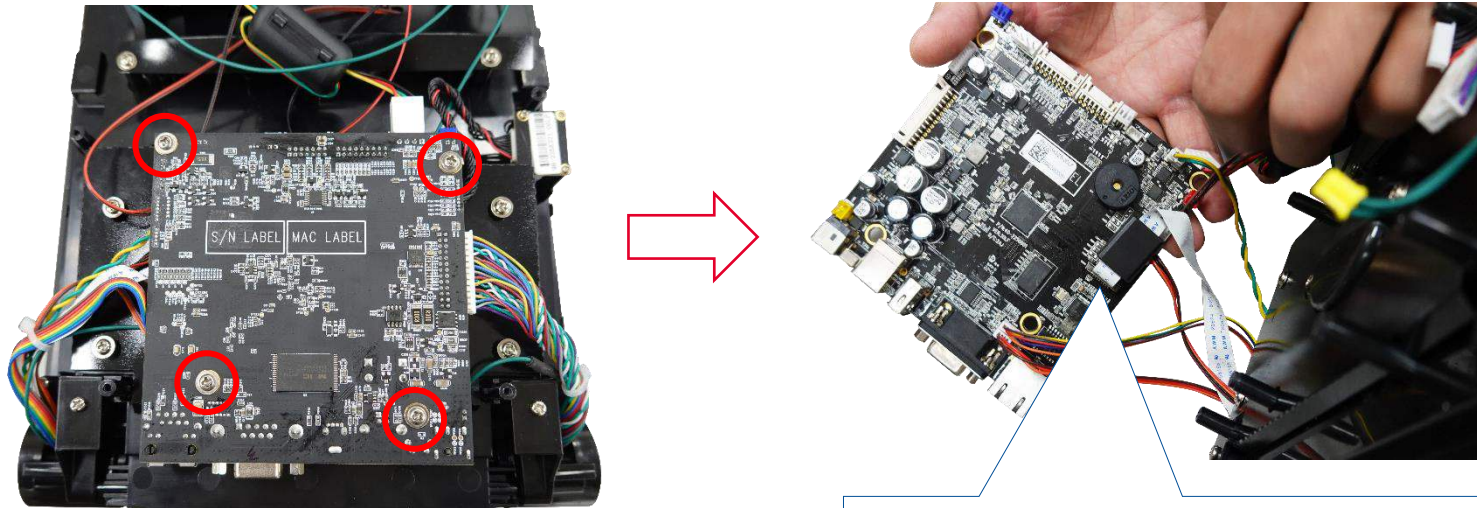

Note:

For flat cables, press the plug to unlock it from connector on the main board, and carefully pull the flat cable free.

4. Reverse the steps of the removal procedure.

3.9 Replacing the SD Card Board

1. Follow the steps in [Before You Begin](#) to prepare the printer.
2. Remove the SD card, if one is installed, from the SD card slot.
3. Refer to [Replacing the Lower Cover](#) to remove the printer lower cover.
4. Remove two screws on SD card board. Unplug one cable connector from the SD card board. Remove/ Replace the SD card board.

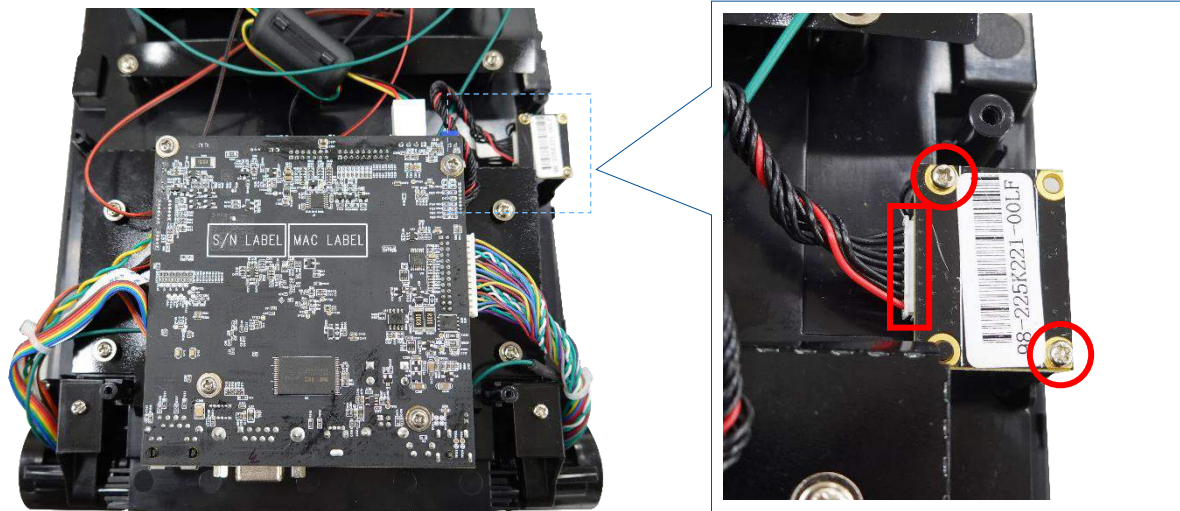

5. Reverse the steps of the removal procedure.

3.10 Replacing the Stepping Motor

1. Follow the steps in [Before You Begin](#) to prepare the printer.
2. Refer to [Replacing the Lower Cover](#) to remove the printer lower cover.
3. Remove two screws securing the stepping motor to the base of the printer frame.

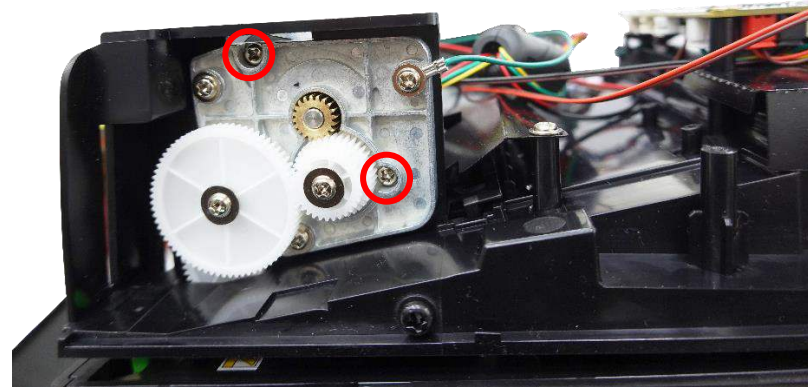

4. Disconnect the cable connector from the main board. Remove/ Replace the stepping motor.

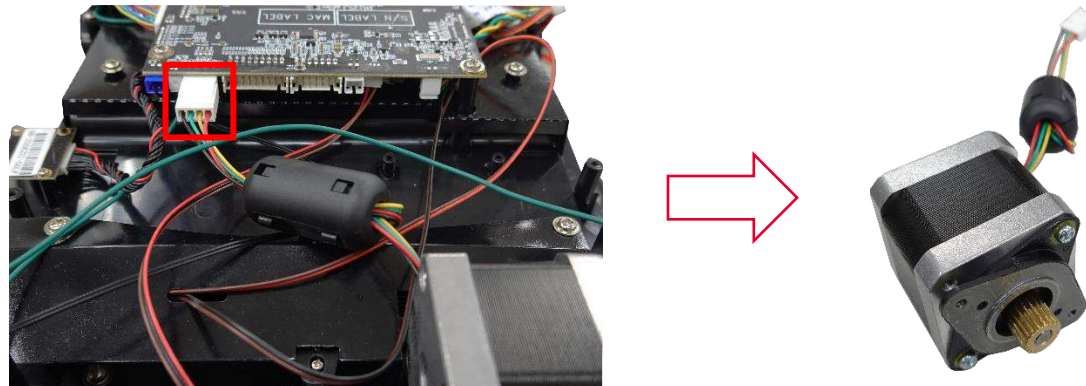

5. Reverse the steps of the removal procedure.

3.11 Replacing the DC Motor Module/ Ribbon Encoder Sensor

1. Follow the steps in [Before You Begin](#) to prepare the printer.
2. Refer to [Replacing the Top Cover](#) to remove the printer top cover. Remove three screws securing DC motor to the fixing plate. Remove two screws securing ribbon encoder sensor to the fixing plate, then install it to new DC motor module.

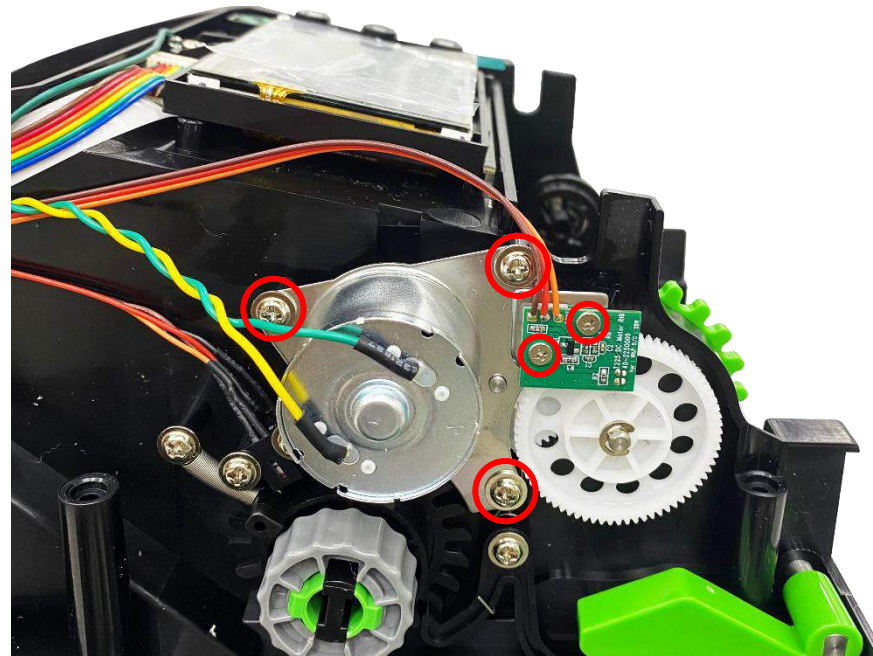

3. Refer to the [Replacing the Main Board](#) to disconnect the DC motor cable connector from main board.
4. Replace the DC motor module.
5. Reverse the steps of the removal procedure.

3.12 Replacing the Ribbon End Sensor

1. Follow the steps in [Before You Begin](#) to prepare the printer.
2. Refer to [Replacing the Top Cover](#) to remove the printer top cover.
3. Remove two screws securing ribbon end sensor to the printer frame.

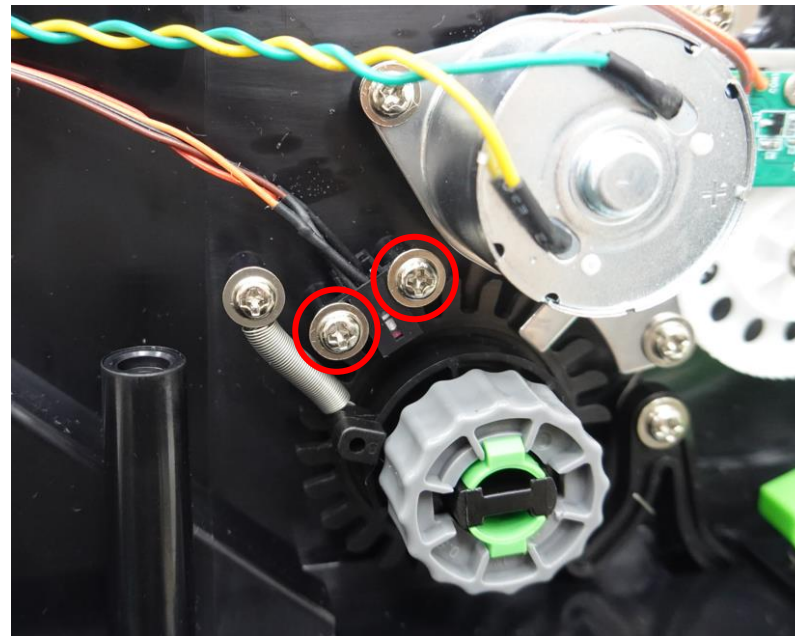

4. Refer to the [Replacing the Main Board](#) to disconnect the ribbon end sensor cable connector from main board.
5. Remove/ Replace the ribbon end sensor.
6. Reverse the steps of the removal procedure.

3.13 Replacing the Black Mark Sensor

1. Follow the steps in [Before You Begin](#) to prepare the printer.
2. Refer to [Replacing the Stepping Motor](#) to remove the stepping motor.
3. Remove four screws to remove the mylar.

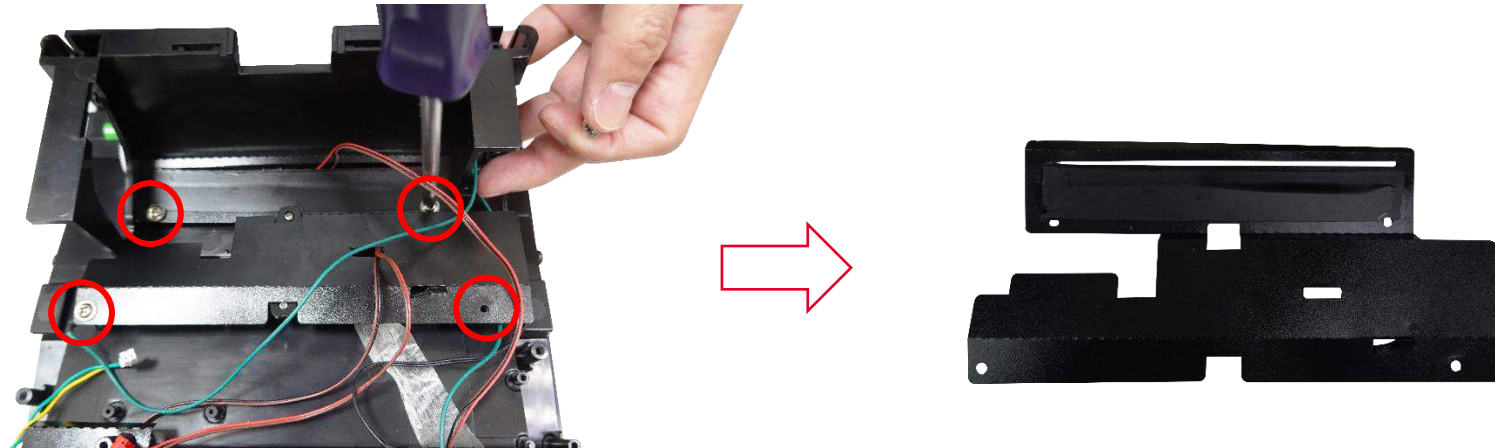

4. Disconnect the black mark sensor cable connector and remove one screw securing black mark sensor to the fixing plate.

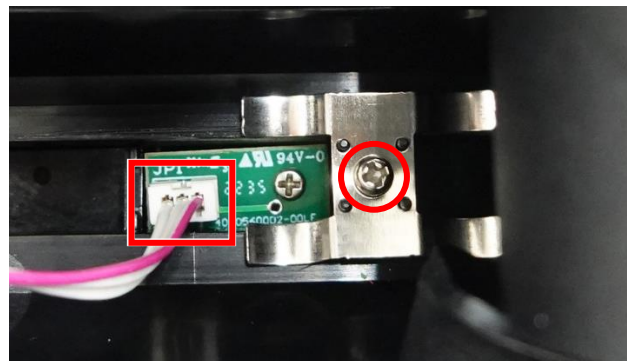

5. Remove/ Replace the black mark sensor. Reverse the steps of the removal procedure.

3.14 Replacing the Head Open Sensor

1. Follow the steps in [Before You Begin](#) to prepare the printer.
2. Refer to [Replacing the Lower Cover](#) to remove the printer lower cover.
3. Remove one screw securing head open sensor to the printer frame. Refer to the [Replacing the Main Board](#) to disconnect the head open sensor cable connector from main board.

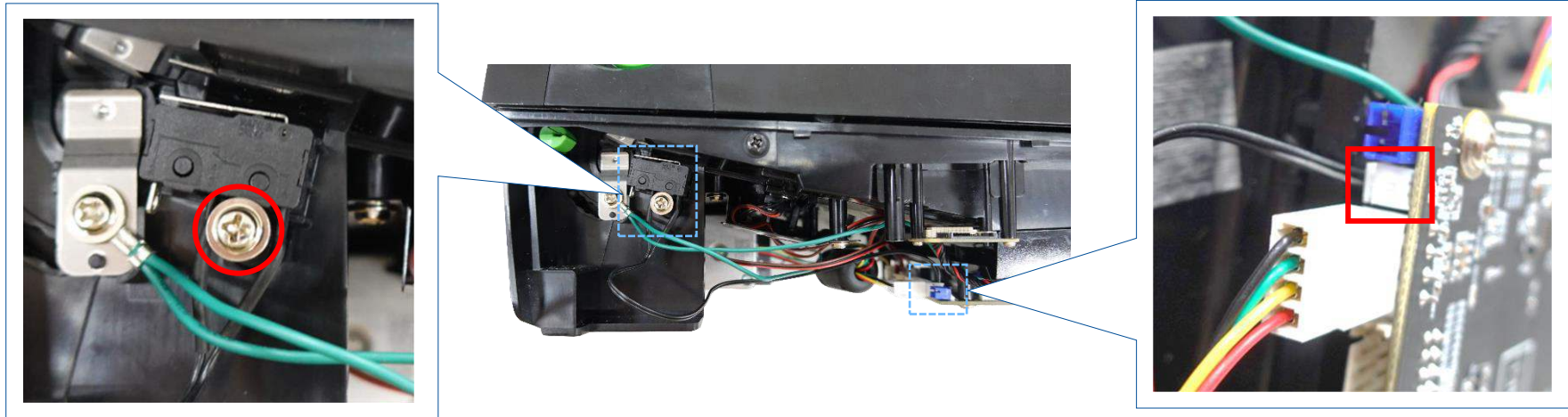

4. Remove/ Replace the head open sensor.
5. Reverse the steps of the removal procedure.

3.15 Replacing the Printer Cover Hook

1. Follow the steps in [Before You Begin](#) to prepare the printer.
2. Refer to [Replacing the Top Cover](#) to remove the printer top cover.
3. Remove both side springs under the cover hooks to replace the hooks.

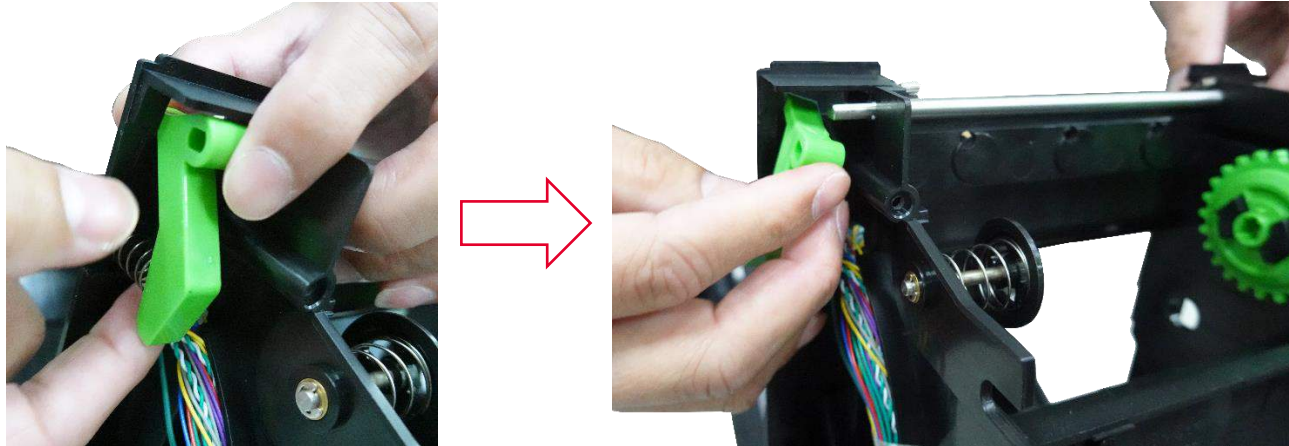

4. Reverse the steps of the removal procedure.

3.16 Installing the Wi-Fi/ Bluetooth Module

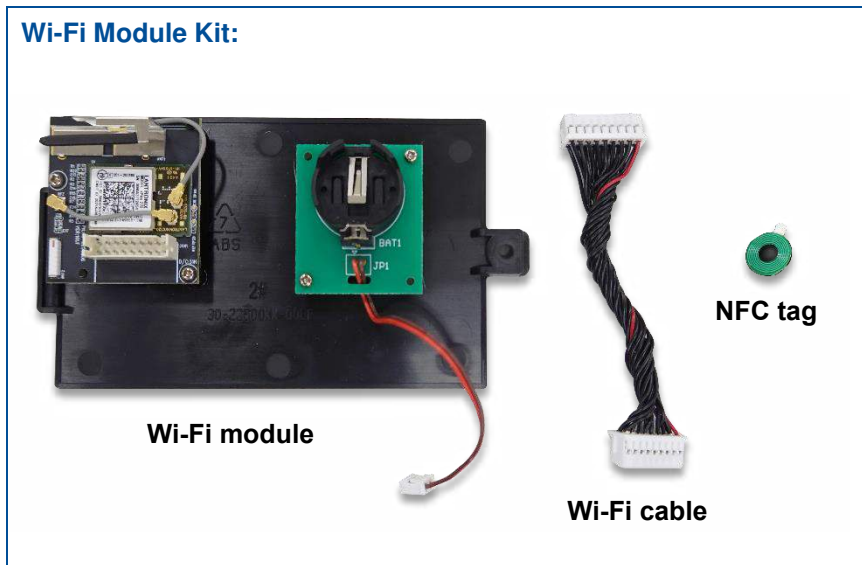

Note:
The Wi-Fi module and the Bluetooth module are installed in the same way, and this section mainly demonstrates the Wi-Fi module.

1. Follow the steps in [Before You Begin](#) to prepare the printer.
2. Put the printer upside down. Remove one screw as shown to disconnect RTC connector. Remove the RTC module.

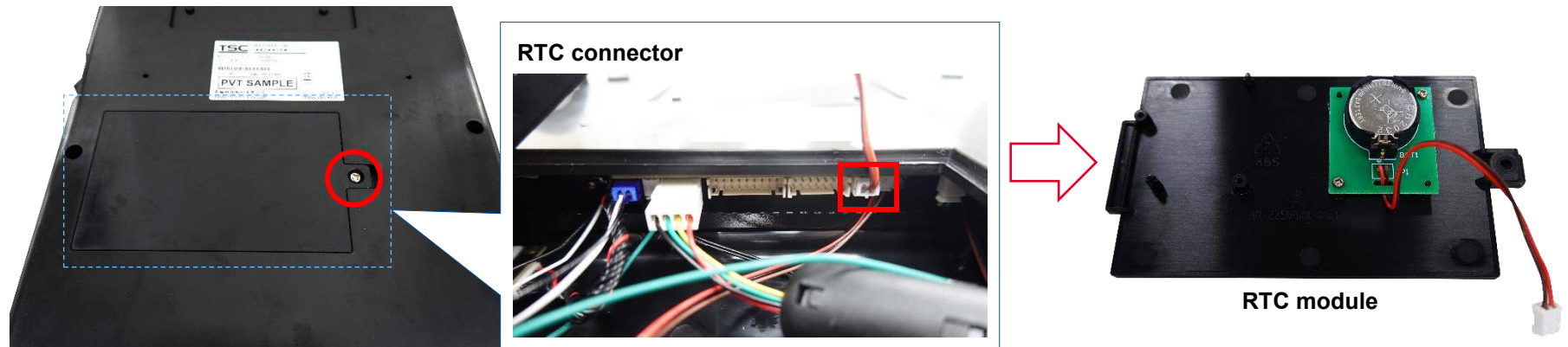

3. Connect the Wi-Fi cable to Wi-Fi module and install the battery to RTC on Wi-Fi module.

Note: RTC battery (CR2032) is not included in the wireless module kit.

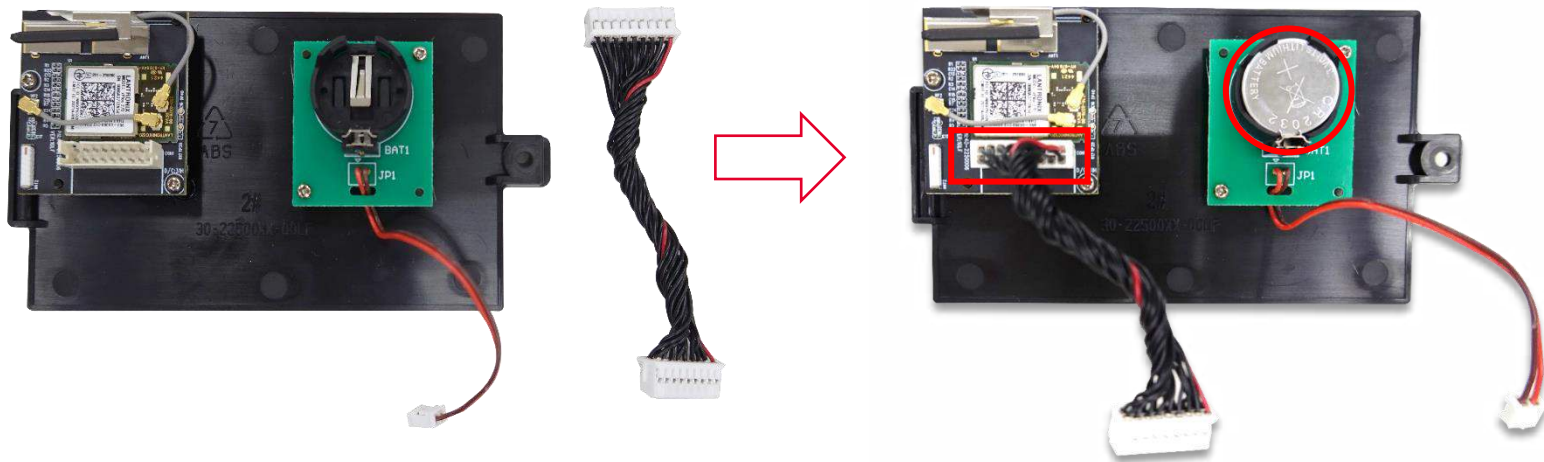

4. Connect another side of Wi-Fi cable and RTC cable into the main board.

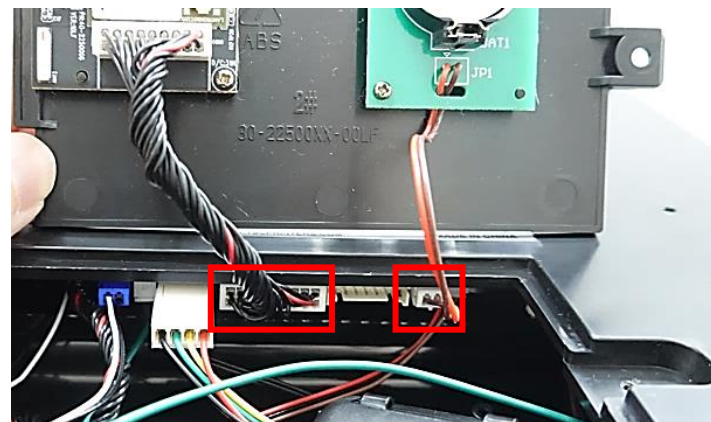

5. Install the Wi-Fi module to the bottom of the printer with one screw.

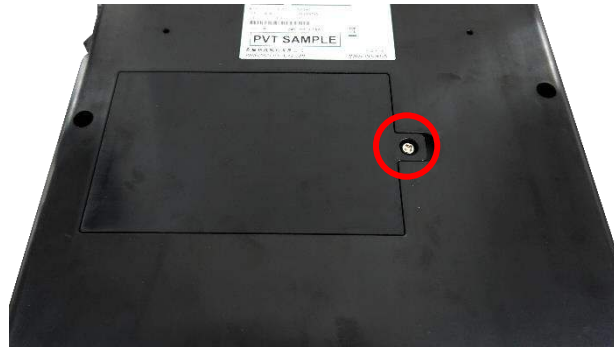

6. For LED version printer, refer to [Replacing the Top Cover](#) to stick the NFC tag on the LED top cover.
For LCD version printer, refer to [Replacing the Control Panel Assembly](#) to stick the NFC tag on the LCD module bracket.

LED version (NFC tag on top cover)	LCD version (NFC tag on LCD module bracket)
A photograph of the interior of a printer chassis for the LED version. A green circular NFC tag is attached to the left side of the chassis, circled in red. The chassis has several circular holes and a rectangular cutout on the right side.	A photograph of the LCD module bracket for the LCD version printer. A green circular NFC tag is attached to the top right corner of the bracket, circled in red. The bracket has several circular holes and a rectangular cutout.

7. Reassemble the parts in the reverse procedures.

3.17 Installing the Cutter Module

1. Follow the steps in [Before You Begin](#) to prepare the printer.
2. Open the top cover to remove the lower front panel as shown.

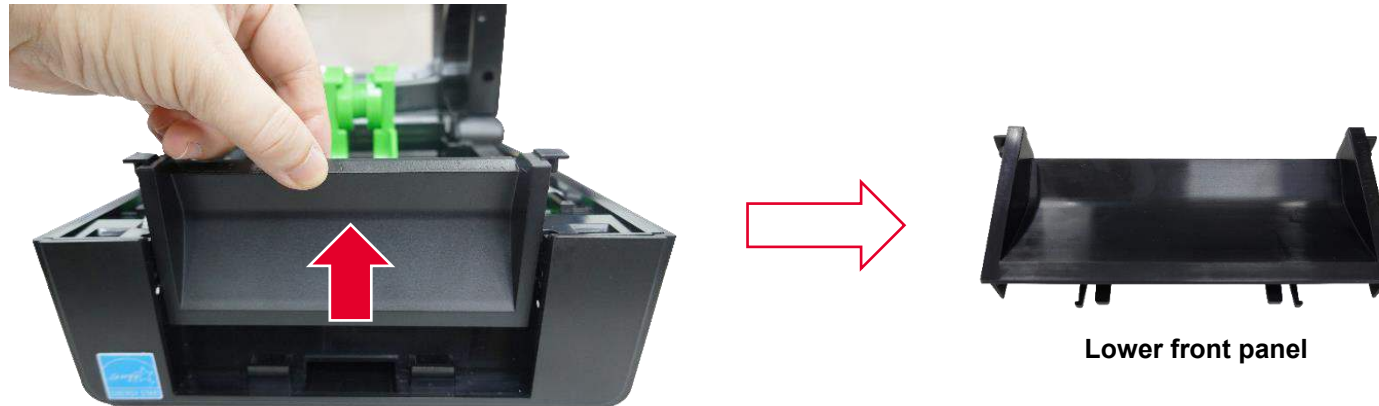

3. Thread the module's cables through the opening on the front side of the printer.

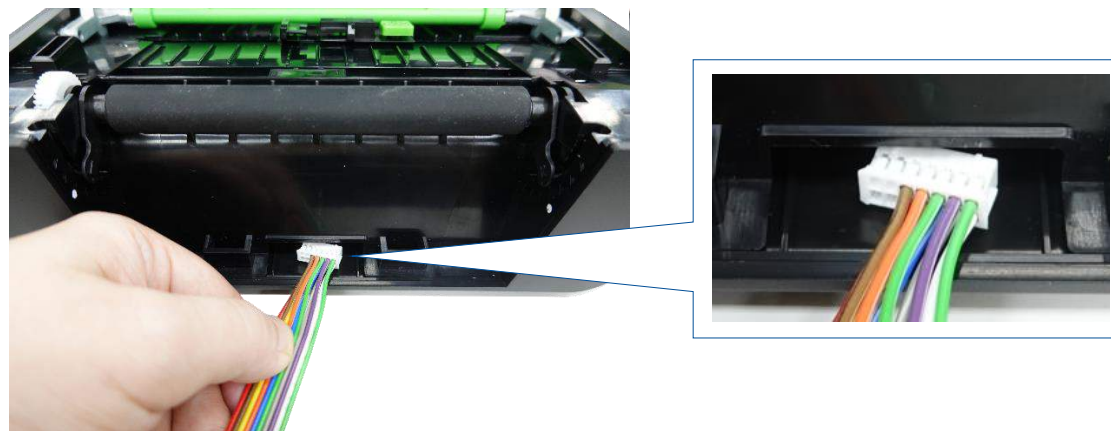

4. Press down to install the module ensuring that the ribs on the module are correctly inserted into the indicated openings.

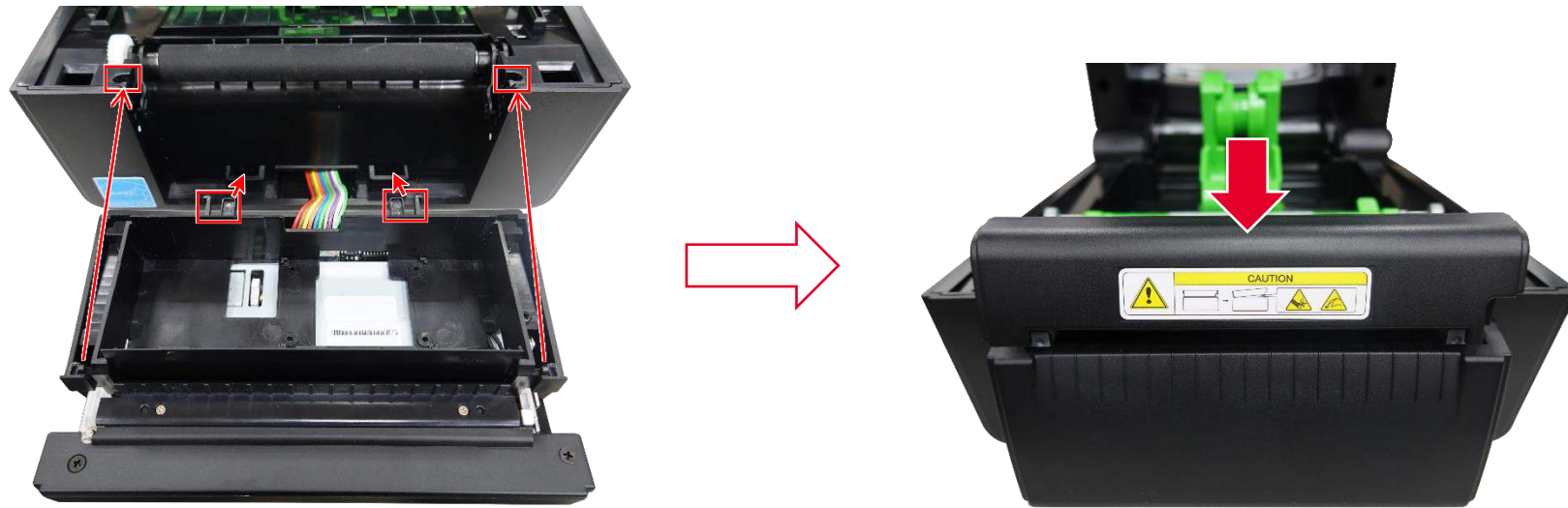

Note:

Make sure that the cable is fed completely into the printer and that the cable is not pressed during installation.

5. Close the printer cover. Put the printer upside down to remove one screw securing the RTC module cover in place and then open the cover. Connect the module's cable harness to the connector on the main board.

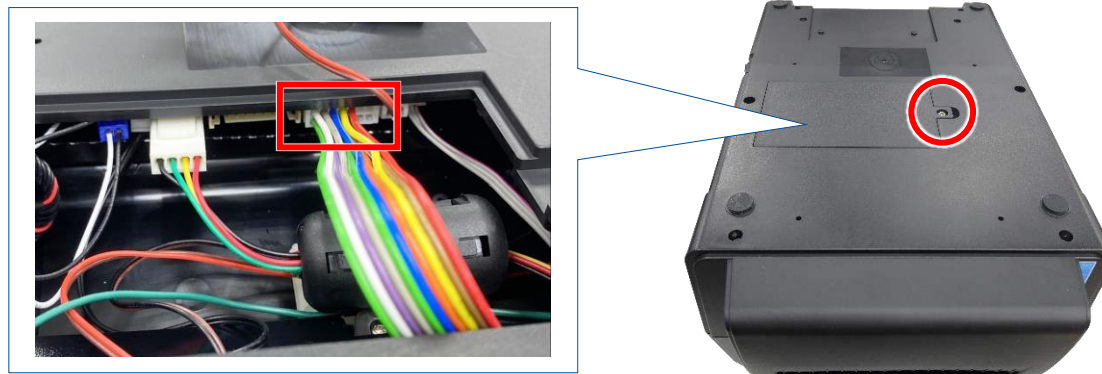

6. Reassemble the RTC module cover and install the single screw to secure the cover in place.

3.18 Installing the Peel-off Module

1. Follow the steps in [Before You Begin](#) to prepare the printer.
2. Open the top cover to remove the lower front panel as shown.

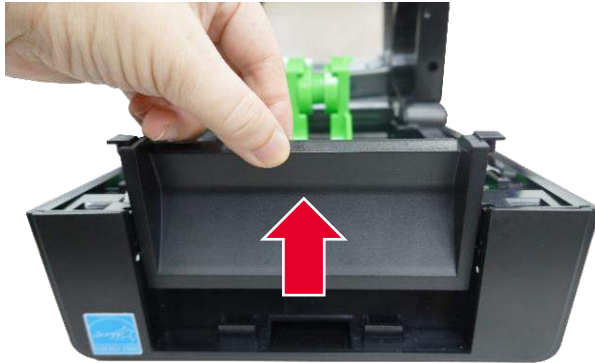

Lower front panel

3. Open the peel roller.



4. Thread the module's cables through the opening on the front side of the printer.

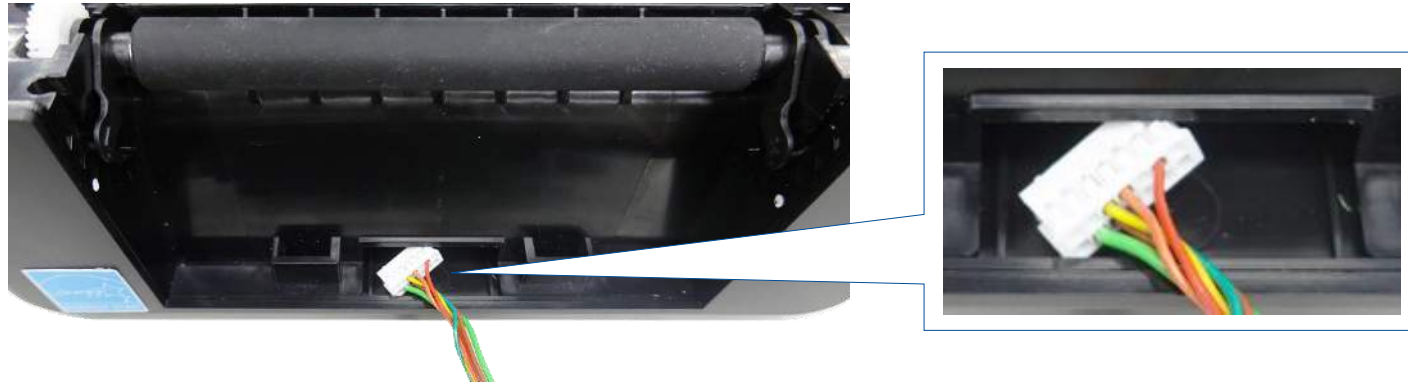

5. Press down to install the module ensuring that the ribs on the module are correctly inserted into the indicated openings.

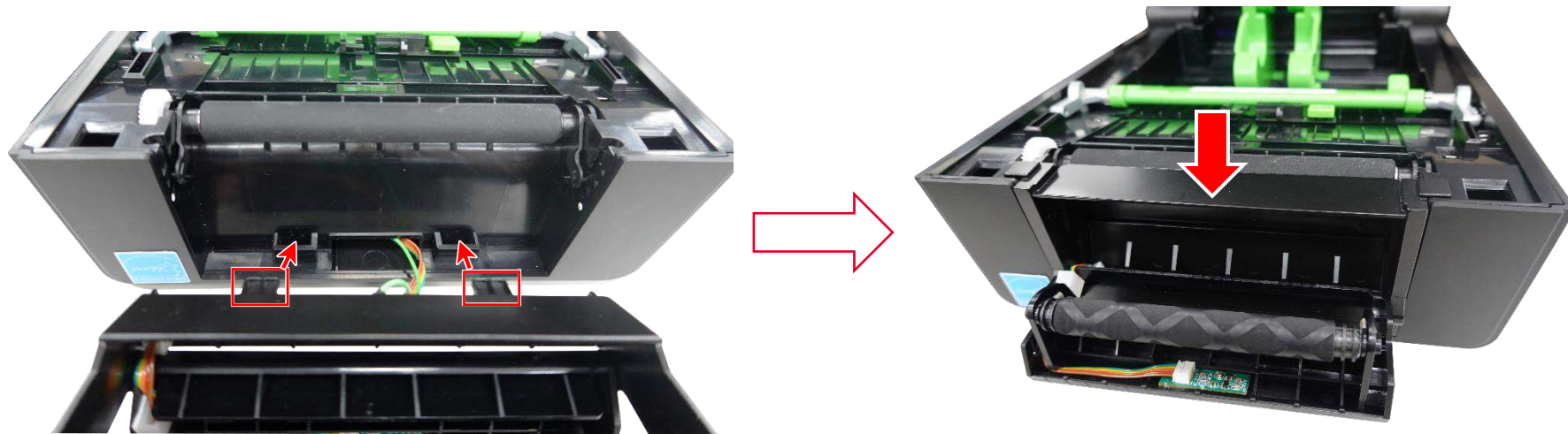

Note:

Make sure that the cable is fed completely into the printer and that the cable is not pressed during installation.

6. Close the peel roller and the printer cover.

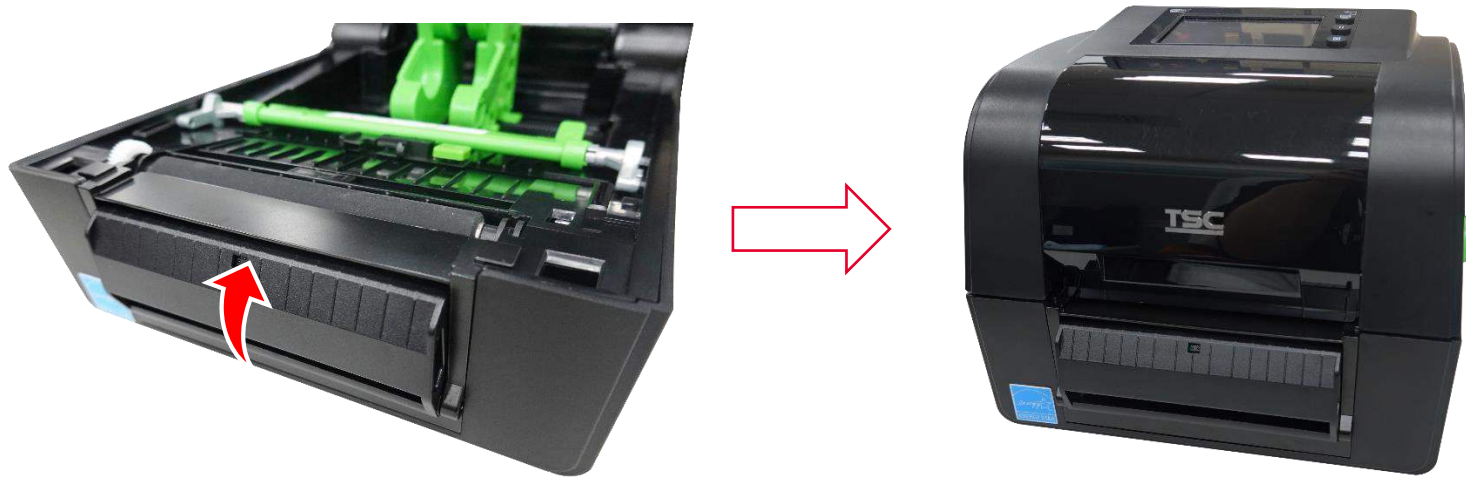

7. Put the printer upside down to remove one screw securing the RTC module cover in place and then open the cover. Connect the module's cable harness to the connector on the main board.

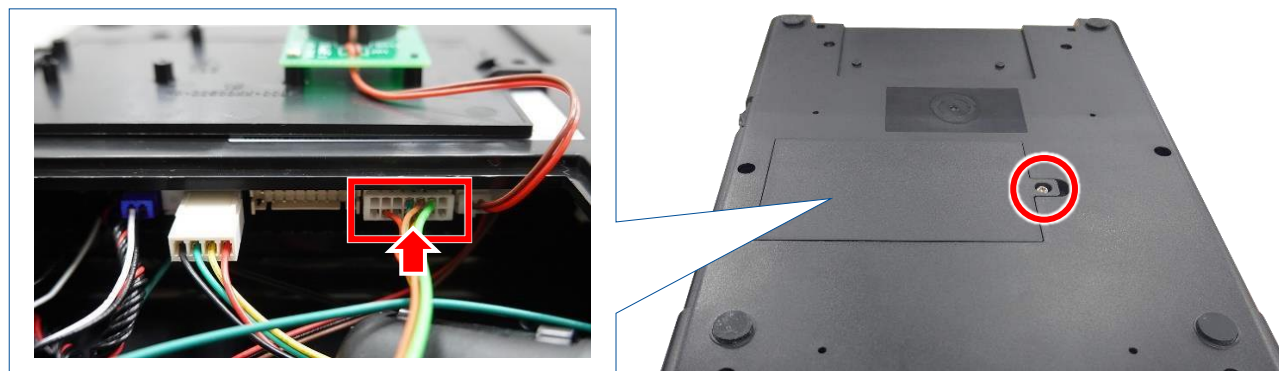

8. Reassemble the RTC module cover and install the single screw to secure the cover in place.

3.19 Installing the Narrow Media Adaptor

1. Open the printer's top cover and separate the media holders, then press down the media holder lock switch to fix the media holder. Remove the two screws on media holder as shown to remove both side of media 3inch cores.

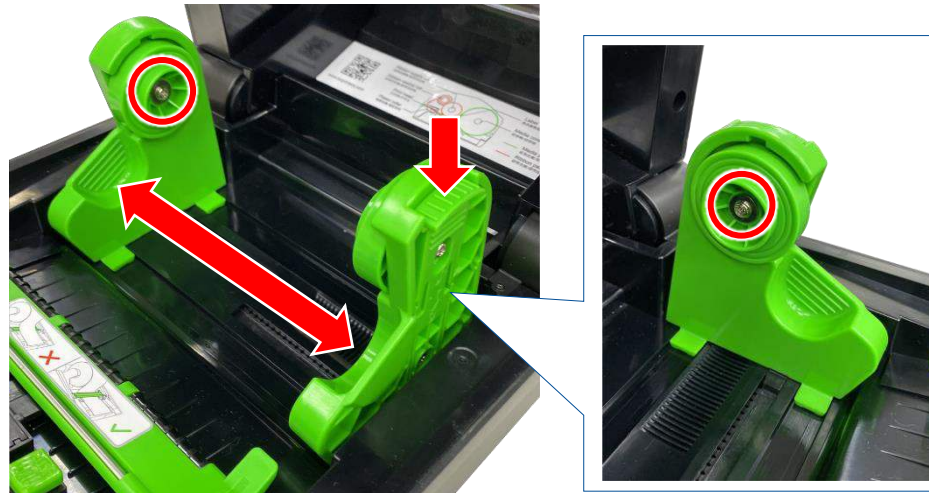

2. Install the narrow media cores on both side of media holder as shown.



3. Install two gray narrow media adapters on both side of media guide. Note that there are left and right sides of the narrow media adapters.

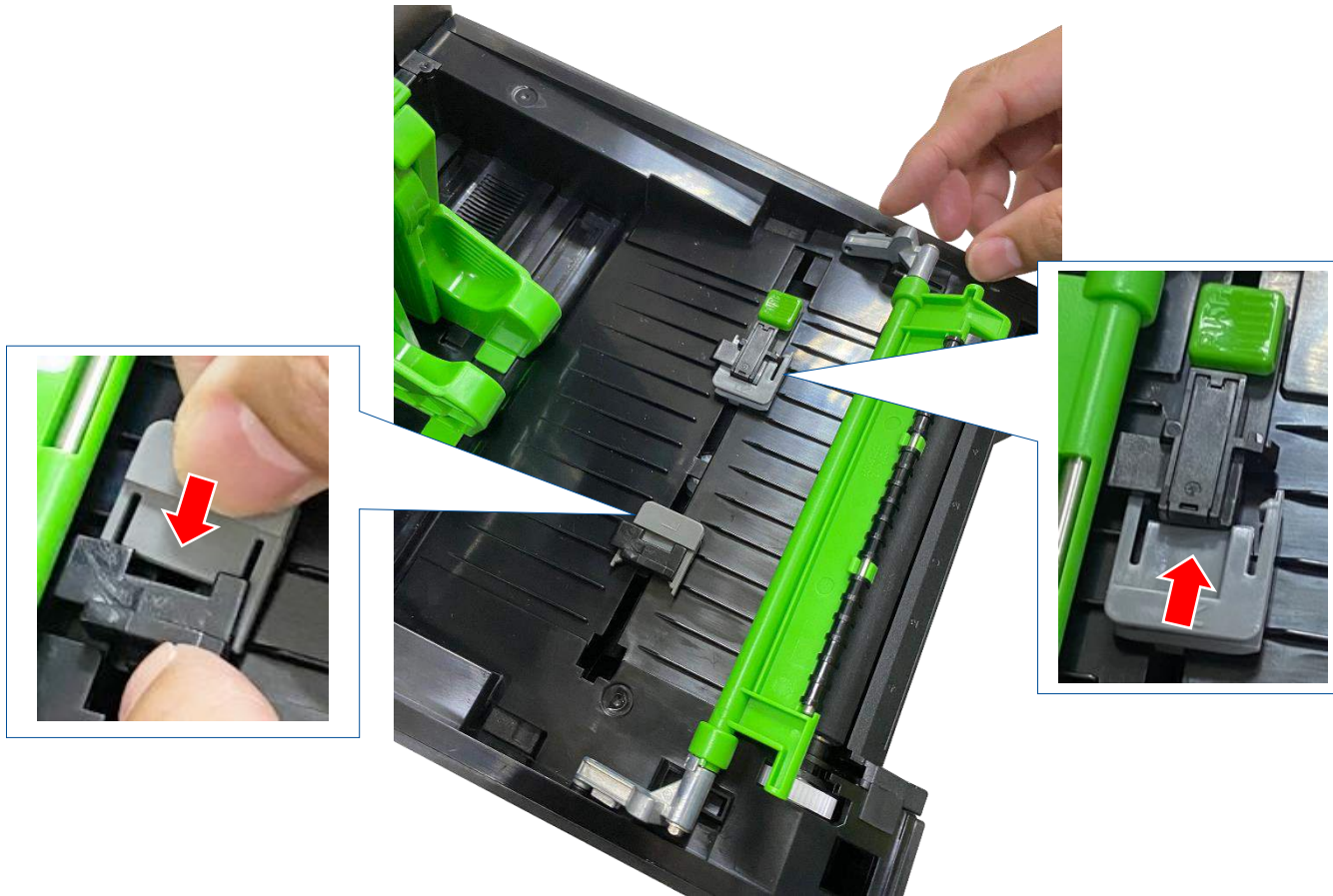

4 Troubleshooting

4.1 Common Problems

Problem	Possible Cause	Recovery Procedure
Power indicator/ LCD does not illuminate	The power cord is not properly connected.	<ul style="list-style-type: none"> • Plug the power cord in printer and outlet. • Switch the printer on.
LED turn on (Carriage Open)	The printer head is open.	Please close the print carriages.
Not Printing	<ul style="list-style-type: none"> • Check if interface cable is well connected to the interface connector. • Check if wireless or Bluetooth device is well connected between host and printer. • The port specified in the Windows driver is not correct. 	<ul style="list-style-type: none"> • Re-connect cable to interface or change a new cable. • If using serial cable, <ul style="list-style-type: none"> - Please replace the cable with pin to pin connected. - Check the baud rate setting. The default baud rate setting of printer is 9600,n,8,1. • If using the Ethernet cable, <ul style="list-style-type: none"> - Check if the Ethernet RJ-45 connector green LED is lit on. - Check if the Ethernet RJ-45 connector amber LED is blinking. - Check if the printer gets the IP address when using DHCP mode. - Check if the IP address is correct when using the static IP address. - Wait a few seconds let the printer get the communication with the server

Problem	Possible Cause	Recovery Procedure
		<p>then check the IP address setting again.</p> <ul style="list-style-type: none"> • Please reset the wireless device setting. • Select the correct printer port in the driver. • Print head's harness connector is not well connected with printhead. Turn off the printer and plug the connector again. • Check your program if there is a command PRINT at the end of the file and there must have CRLF at the end of each command line.
No print on the label	<ul style="list-style-type: none"> • Label or ribbon is loaded not correctly. • Use wrong type paper or ribbon 	<ul style="list-style-type: none"> • Follow the instructions in loading the media and ribbon. • Ribbon and media are not compatible. • Verify the ribbon-inked side. • The print density setting is incorrect. • Clean the print head.
No Ribbon	<ul style="list-style-type: none"> • Running out of ribbon. • The ribbon is installed incorrectly. 	<ul style="list-style-type: none"> • Supply a new ribbon roll. • Please refer to the steps in user's manual to reinstall the ribbon.
No Paper	<ul style="list-style-type: none"> • Running out of label. • The label is installed incorrectly. • Gap/black mark sensor is not calibrated. 	<ul style="list-style-type: none"> • Supply a new label roll. • Reinstall the label roll. • Calibrate the gap/black mark sensor.

Problem	Possible Cause	Recovery Procedure
Paper jam	<ul style="list-style-type: none"> • Gap/black mark sensor is not set properly. • Make sure label size is set properly. • Labels may be stuck inside the printer mechanism. 	<ul style="list-style-type: none"> • Calibrate the media sensor. • Set media size correctly. • Remove the stuck label inside the printer mechanism.
Can't downloading the file to memory (FLASH / CARD)	The space of memory is full.	Delete unused files in the memory.
SD card is unable to use	<ul style="list-style-type: none"> • SD card is damaged. • SD card doesn't insert correctly. • Use the non-approved SD card manufacturer. 	<ul style="list-style-type: none"> • Use the supported capacity SD card. • Insert the SD card again.
Poor Print Quality	<ul style="list-style-type: none"> • Ribbon and media is loaded incorrectly • Dust or adhesive accumulation on the print head. • Print density is not set properly. • Print head element is damaged. • Ribbon and media are incompatible. • The print head pressure is not set properly. 	<ul style="list-style-type: none"> • Reload the supply. • Clean the print head. • Clean the platen roller. • Adjust the print density and print speed. • Run printer self-test and check the print head test pattern if there is dot missing in the pattern. • Change proper ribbon or proper label media. • The release lever does not latch the print head properly.
Missing printing on the left or right side of label	Wrong label size setup.	Set the correct label size.

Problem	Possible Cause	Recovery Procedure
Gray line on the blank label	<ul style="list-style-type: none"> The print head is dirty. The platen roller is dirty. 	<ul style="list-style-type: none"> Clean the print head. Clean the platen roller.
Irregular printing	<ul style="list-style-type: none"> The printer is in Hex Dump mode. The RS-232 setting is incorrect. 	<ul style="list-style-type: none"> Turn off and on the printer to skip the dump mode. Re-set the Rs-232 setting.
Label feeding is not stable (skew) when printing	The media guides do not touch the edge of the media.	<ul style="list-style-type: none"> If the label is moving to the right side, please move the label guide to left. If the label is moving to the left side, please move the label guide to right.
Skip labels when printing	<ul style="list-style-type: none"> Label size is not specified properly. Sensor sensitivity is not set properly. The media sensor is covered with dust. 	<ul style="list-style-type: none"> Check if label size is setup correctly. Calibrate the sensor by Auto Gap or Manual Gap options. Clear the GAP/Black mark sensor by blower.
Wrinkle Problem	<ul style="list-style-type: none"> Printhead pressure is incorrect. Ribbon installation is incorrect. Media installation is incorrect. Print density is incorrect. Media feeding is incorrect. 	<ul style="list-style-type: none"> Please set the suitable density to have good print quality. Make sure the label guides touch the edge of the media guide.
RTC time is incorrect when reboot the printer	The battery has run down.	Check if there is a battery on the main board.
The left side printout position is incorrect	<ul style="list-style-type: none"> Wrong label size setup. The parameter Shift X in printer is incorrect. 	Set the correct label size.

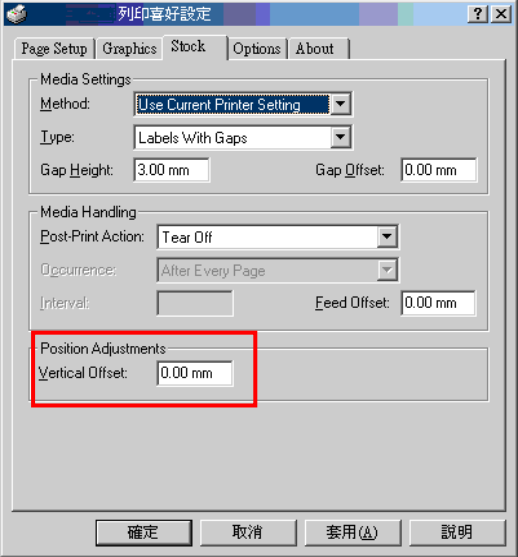
Problem	Possible Cause	Recovery Procedure
<p>The printing position of small label is incorrect</p>	<ul style="list-style-type: none"> Media sensor sensitivity is not set properly. Label size is incorrect. The parameter Shift Y is incorrect. The vertical offset setting in the driver is incorrect. 	<ul style="list-style-type: none"> Calibrate the sensor sensitivity again. Set the correct label size and gap size. Enter LCD menu (or via TSC Console) to fine tune the parameter of Shift Y. If using the software BarTender, please set the vertical offset in the driver. 

5 Maintenance

This session presents the clean tools and methods to maintain the printer.

■ For Cleaning

Depending on the media used, the printer may accumulate residues (media dust, adhesives, etc.) as a by-product of normal printing. To maintain the best printing quality, you should remove these residues by cleaning the printer periodically. Regularly clean the print head and supply sensors once change a new media to keep the printer at the optimized performance and extend printer life.

■ For Disinfecting

Sanitize your printer to protect yourself and others and can help prevent the spread of viruses.

■ Important

- Set the printer power switch to O (Off) prior to performing any cleaning or disinfecting tasks. Leave the power cord connected to keep the printer grounded and to reduce the risk of electrostatic damage.
- Do not wear rings or other metallic objects while cleaning any interior area of the printer.
- Use only the cleaning agents recommended in this document. Use of other agents may damage the printer and void its warranty.
- Do not spray or drip liquid cleaning solutions directly into the printer. Apply the solution on a clean lint-free cloth and then apply the dampened cloth to the printer.
- Do not use canned air in the interior of the printer as it can blow dust and debris onto sensors and other critical components.
- Only use a vacuum cleaner with a nozzle and hose that are conductive and grounded to drain off static build up.
- All reference in these procedures for use of isopropyl alcohol requires that a 99% or greater isopropyl alcohol content be used to reduce the risk of moisture corrosion to the printhead.
- Do not touch printhead by hand. If you touch it carelessly, please use 99% Isopropyl alcohol to clean it.

- Always taking personal precaution when using any cleaning agent.

Cleaning Tools:

- Cotton swab
- Lint-free cloth
- Brush with soft non-metallic bristles
- Vacuum cleaner
- 75% Ethanol (for disinfecting)
- 99% Isopropyl alcohol (for printhead and platen roller cleaning)
- Genuine printhead cleaning pen
- Mild detergent (without chlorine)

Cleaning Process:

Printer Part	Method	Interval
Print Head	<ol style="list-style-type: none"> I. Always turn off the printer before cleaning the printhead. II. Allow the printhead to cool for at least one minute. III. Use a cotton swab and 99% Isopropyl Alcohol or genuine print head cleaning pen to clean the print head surface. 	Clean the print head when changing a new label roll.
Platen Roller	<ol style="list-style-type: none"> I. Turn off the printer. II. Rotate the platen roller and wipe it thoroughly with the lint-free 99% Isopropyl Alcohol. 	Clean the platen roller when changing a new label roll
Peel Bar	Use the lint-free cloth with 99% Isopropyl Alcohol to wipe it.	As needed

Printer Part	Method	Interval
Sensor	<p>Use brush with soft non-metallic bristles or a vacuum cleaner, to remove paper dust.</p> <p>Clean upper and lower media sensors to ensure reliable Top of Form and Paper Out sensing.</p>	Monthly
Exterior	<p>Clean the exterior surfaces with a clean, lint-free cloth (water-dampened cloth). If necessary, use a mild detergent or desktop cleaning solution then use the 75% Ethanol to wipe it.</p>	As needed
Interior	<p>Clean the interior of the printer by removing any dirt and lint with a vacuum cleaner, as described above, or use a brush with soft non-metallic bristles then use the 75% Ethanol to wipe it.</p>	As needed

Revision History

Date	Content	Editor
2023/9/6	Add the Installing the Narrow Media Adaptor section	Camille
2023/9/8	Add the Installing the Cutter Module section Modify the Installing the Peel-off Module section	Camille
2023/10/12	Add the Replacing the Head Open Sensor section	Camille



www.tscprinters.com