

Mobile Barcode Printer

# Alpha-30R

Direct Thermal

## Series Models

Alpha-30R



**User Manual**

# Copyright

©2024 TSC Auto ID Technology Co., Ltd.

The copyright in this manual, the software and firmware in the printer described are owned by TSC Auto ID Technology Co., Ltd. All rights reserved.

CG Triumvirate is a trademark of Agfa Corporation. CG Triumvirate Bold Condensed font is under license from the Monotype Corporation. Windows is a registered trademark of Microsoft Corporation.

All other trademarks are the property of their respective owners. Information in this document is subject to change without notice and does not represent a commitment on the part of TSC Auto ID Technology Co. No part of this manual may be reproduced or transmitted in any form or by any means, for any purpose other than the purchaser's personal use, without the expressed written permission of TSC Auto ID Technology Co.



# Contents

- 1 Introduction ..... 3**
  - 1.1 Specifications ..... 4
- 2 Unpacking and Inspecting ..... 7**
- 3 Getting to Know Your Printer ..... 8**
  - 3.1 Front View ..... 8
  - 3.2 Inner View ..... 9
  - 3.3 Bottom & Rear View ..... 10
- 4 Setting up the Printer ..... 11**
  - 4.1 Installing the Battery ..... 11
  - 4.2 Charging the Battery / Smart Battery ..... 12
  - 4.3 Loading the Media ..... 18
  - 4.4 Loading the Linerless Media (Linerless Model) ..... 20
  - 4.5 Installing the Belt Clip ..... 22
  - 4.6 Using the IP54 Case with Shoulder Strap (optional) ..... 23
- 5 Operator Interface ..... 24**
- 6 TSC Console ..... 26**
  - 6.1 Launching TSC Console ..... 26
  - 6.2 Adding Wi-Fi Interface ..... 28
  - 6.3 Configuring Bluetooth ..... 32
  - 6.4 Initializing Printer's Wi-Fi Settings ..... 34
  - 6.5 TPH Care ..... 35
  - 6.6 Printer's Main Functions ..... 37
  - 6.7 Configuring Optional Kits ..... 38
  - 6.8 Smart Battery (Mobile Printers only) ..... 39
- 7 Troubleshooting ..... 40**

**8 Maintenance ..... 42**  
    8.1 Cleaning Supplies .....43  
    8.2 Cleaning Procedures.....44  
**9 Agency Compliance and Approvals ..... 45**  
**Revision History..... 56**

# 1 Introduction

The new generation TSC mobile printer, the Alpha-30R, is user-friendly and drop-resistant. It enhances customer service, boosts productivity and improves shopper experience in retail stores. The Alpha-30R is stylish and comfortable in use and prints receipts or labels on-demand. Mobile printing operations can be carried out much faster and with more accuracy.

The Alpha-30R is compact and very efficient, it also has a large capacity smart battery that enables it to carry out a full shift of work without interruption. The Apple-certified MFi Bluetooth® 5.0 connection and 802.11ac Wi-Fi fast roaming features allow the Alpha-30R to provide reliable and seamless communication with user devices to achieve optimal mobile field-work.

The Alpha-30R's smart battery paired with SOTI Connect and TSC Console remote printer management gives real-time visibility that helps enterprises scale their business activities seamlessly and efficiently.

The Alpha-30R design emphasizes durability, it has the most robust specifications in its class. The ruggedness of the Alpha-30R meets MIL-STD-810 military-grade standards for drop and vehicle vibrations. It has an IP54 rating and will withstand a 2.1 m drop and a 1.0 m tumble. While the protective case allows it to withstand a 2.5 m drop in a harsh environment.

The Alpha-30R has a full line of accessories to meet a range of different environments on the go. It is especially suited for retail applications. It is also environmentally friendly and can support linerless media printing to reduce waste. Go green!

This document provides an easy reference for operating this printer. TSC printers include the Windows labeling software for creating your label template. For system integration, the TSPL/TSPL2 printer programming manual or SDKs can be found on TSC website at: <https://www.tscprinters.com>.

## 1.1 Specifications

Model	Alpha-30R Basic	Alpha-30R Premium
Resolution	8 dots/mm (203 dpi)	
Printing Method	Direct Thermal	
Max. Print Speed	Up to 127 mm (5")/second	Up to 152 mm (6")/second
Max. Print Width	72 mm (2.83")	
Max. Print Length	2,794 mm (110")	
Enclosure	Plastic with rubber over molded	
Physical Dimension	118 mm (W) x 158 mm (H) x 68 mm (D) 4.64" (W) x 6.22" (H) x 2.68" (D)	
Weight (Including Battery)	650 g (1.43 lbs.)	
Drop Specification	2.1 m (6.9 ft), with protective case can be 2.5 m (8.2 ft)	
MIL-STD 810	Drop and vibration	
Tumble Test	800 free falls from 1 m (3.3 ft), with protective case can be 1000 free falls from 1 m (3.3 ft)	
IP Rating	IP54 (without case, paper path is excluded)	
Max. Roll Capacity	57 mm (2.24") OD	
Processor	32-bit RISC CPU	
Memory	128MB SDRAM, 128MB Flash	
Connectivity	Two options: <ul style="list-style-type: none"> <li>• Type C USB 2.0 + MFi Bluetooth 5.0 + Passive NFC tag</li> <li>• Type C USB 2.0 + 802.11 a/b/g/n/ac with Bluetooth 5.0 + Passive NFC tag</li> </ul> <b>NOTE:</b> The Type C connector is used for communication only.	
Power	7.4V DC, 3080mAh Li-ion rechargeable battery	7.4V DC, 3030mAh Li-ion rechargeable smart battery
User Interface	<ul style="list-style-type: none"> <li>• 3 buttons (Power On/Off, feed, and cover-open)</li> <li>• 2 color LEDs for printer status and battery charging status</li> <li>• 1 LCD for printer status</li> </ul>	

Model	Alpha-30R Basic	Alpha-30R Premium
<b>Sensors</b>	<ul style="list-style-type: none"> <li>• Reflective sensor</li> <li>• Head open sensor</li> </ul>	<ul style="list-style-type: none"> <li>• Reflective sensor</li> <li>• Transmissive sensor</li> <li>• Head open sensor</li> </ul>
<b>Real Time Clock</b>	Standard	
<b>Internal Fonts</b>	<ul style="list-style-type: none"> <li>• 8 alpha-numeric bitmap fonts</li> <li>• One Monotype Imaging® CG Triumvirate Bold Condensed scalable font</li> </ul>	
<b>Barcode</b>	<ul style="list-style-type: none"> <li>• 1D barcode: Code 39, Code 93, Code128UCC, Code128 subsets A.B.C, Codabar, Interleave 2 of 5, EAN-8, EAN-13, EAN-128, UPC-A, UPC-E, EAN and UPC 2(5) digits add-on, MSI, PLESSEY, POSTNET, China POST, GS1 Data bar</li> <li>• 2D barcode: PDF-417, Maxicode, DataMatrix, QR code, Aztec</li> </ul>	
<b>Printer Language</b>	TSPL-EZC (EPL2, ZPL2, CPCL), or ESC-POS	
<b>Media Type</b>	Receipt paper, receipt paper with black mark in printing side, selected label, linerless (outside wound)	Receipt paper, receipt paper with black mark in printing side or backside, label, linerless (outside wound)
<b>Media Width</b>	25.4 mm - 80 mm (1" - 3.15") with liner	
<b>Media Thickness</b>	0.06 mm - 0.16 mm (2.36 mil - 6.3 mil)	
<b>Media Height</b>	Label: Min. 25.4 mm (1")	
<b>Media Core Diameter</b>	<ul style="list-style-type: none"> <li>• Standard: 12.7 mm (0.5")</li> <li>• Optional: <ul style="list-style-type: none"> <li>- 19.1 mm (0.75")</li> <li>- 25.4 mm + 38.1 mm (1" + 1.5")</li> </ul> </li> </ul>	
<b>Environment Condition</b>	<ul style="list-style-type: none"> <li>• Operation: -20°C to 55°C (-4°F to 131°F), 10% - 90% non-condensing</li> <li>• Storage: -30°C to 70°C (-22°F to 158°F), 10% - 90% non-condensing</li> </ul>	
<b>Accessories</b>	<ul style="list-style-type: none"> <li>• Quick start guide x1</li> <li>• Belt clip x1</li> <li>• Li-ion battery x1</li> <li>• Power adaptor x1</li> </ul>	
<b>Factory Options</b>	Linerless kit	

Model	Alpha-30R Basic	Alpha-30R Premium
<b>User Options</b>	<ul style="list-style-type: none"> <li>• Type C USB 2.0 cable</li> <li>• 0.75" media core adaptor</li> <li>• 1" + 1.5" media core adaptor</li> <li>• Protective case with shoulder strap</li> <li>• Shoulder strap</li> <li>• 1-slot battery charger</li> <li>• 4-slot battery charger</li> <li>• 12-24V DC vehicle power adaptor</li> <li>• 12-60V DC vehicle power adaptor</li> <li>• 12-60V DC vehicle open end power supply</li> <li>• 12-48V DC power source with battery eliminator</li> <li>• 12-48V wire-to-wire battery eliminator with power supply</li> <li>• Wire-to-wire dummy battery pack</li> <li>• Vehicle mount adaptor can be used with RAM® MOUNTS (for premium model only)</li> <li>• Quick release vehicle mount kit (for premium model only)</li> <li>• 1-slot docking cradle (for premium model only)</li> <li>• 4-slot docking cradle (for premium model only)</li> </ul>	



## 2 Unpacking and Inspecting

The printer has been specially packaged to withstand damage during shipment. Retaining the packaging materials is recommended in case you need to ship the printer. When unpacking, ensure that you have received all the following items:

- Barcode printer x1
- Li-ion battery x1
- Quick installation guide x1
- Auto-switching AC adapter x1
- Belt clip x1

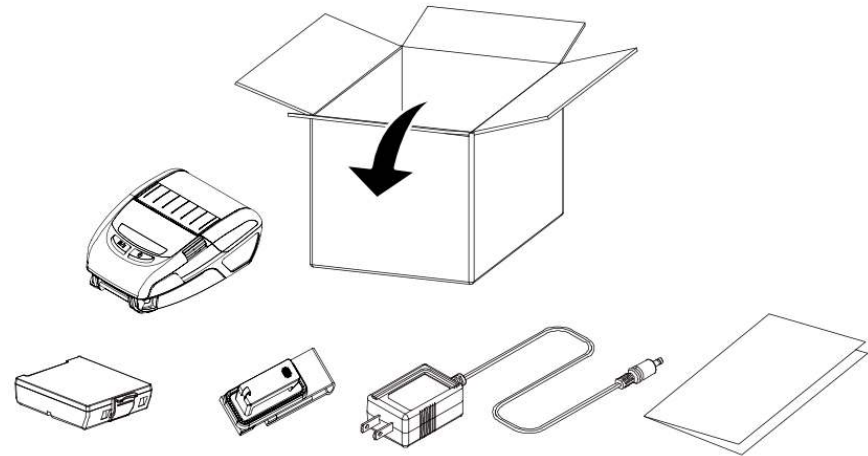

**NOTE:** If anything is missing or damaged, please contact the customer service department of your reseller or distributor.

# 3 Getting to Know Your Printer

## 3.1 Front View



1. Media cover
2. LCD screen
3. Feed/Pause button
4. Media cover release latch
5. Power button

## 3.2 Inner View

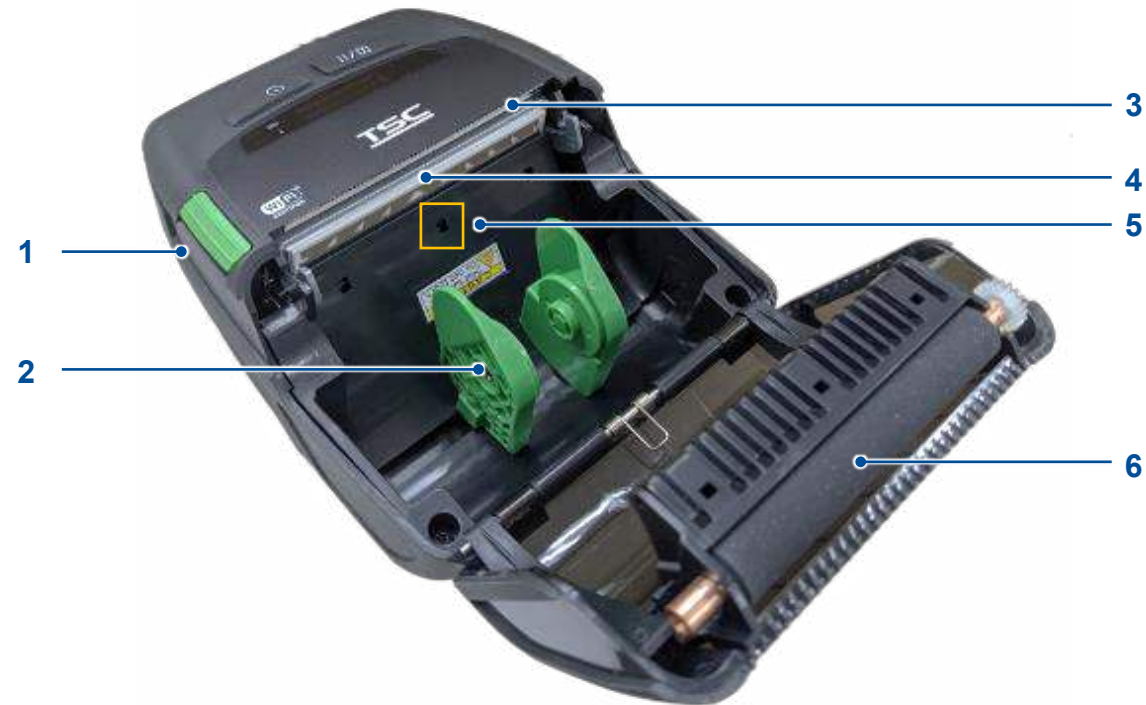

1. Power jack socket & Type C interface
2. Media holder
3. Tear bar
4. Printhead
5. Gap/Black mark sensor
6. Platen roller

### 3.3 Bottom & Rear View



1. Battery clasp
2. Li-ion battery
3. Socket for charging cradle
4. Rings for belt clip

# 4 Setting up the Printer

## 4.1 Installing the Battery



1. Install the battery into its compartment as indicated.



2. Press down the battery to lock the battery in place.  
**WARNING:** DO NOT throw the battery in fire. DO NOT short circuits the battery terminals. DO NOT disassemble the battery.  
**NOTE:** Follow the regulations in your region/country when disposing the battery.

## 4.2 Charging the Battery / Smart Battery

### 4.2.1 Operation Instructions

#### Charging Temperature

The battery's normal working temperature is from 0°C to 40°C (32°F to 104°F). The device and battery charger are designed to charge battery in a safe and optimized manner. If charging the battery at high temperatures, e.g. approximately 40°C (104°F), or charging the battery with printer being turned on, the printer or battery charger may stop charging for a period of time to maintain the battery at acceptable temperatures.

#### Shutdown Mode

**IMPORTANT:** In order to store/ship the battery safely and increase the battery shelf life, the battery is set to the shutdown mode when manufactured. You need to release the smart battery from the shutdown mode when charging the battery for the first time.

Follow the steps below to release the battery from the shutdown state:

- When charging the printer with the battery installed  
No special process is required.
- When charging the battery using a 1-bay or 4-bay charger station
  1. Install the battery on the charger station.
  2. When the LED on the station illuminates blinking red, remove and re-install the battery to deactivate the shutdown mode.

## 4.2.2 Battery Installed in the Printer



1. Open the interface cover and then insert the supplied power connector into the power jack socket.

2. Insert the power plug into the power outlet socket.

3. Insert the power cable connector into the power jack socket.

**IMPORTANT:** Before inserting the power cable connector into the socket, please turn off the printer. **DO NOT** remove the battery from the printer when charging the battery; otherwise, you need to remove and re-insert the power cable.

The battery status LED will remain solid amber until the battery reaches fully charged. Once fully charged, the LED will turn off and the printer will automatically stop charging.

### 4.2.3 Battery Installed on the 1-Bay Charger Station (optional)

**NOTE:** You need to deactivate the shutdown mode for the battery when charging the battery for the first time. For how to deactivate the shutdown mode, please refer to 4.2.1.



1. Place the charger station on a flat surface.



2. Install the battery onto the charger station and then press down the battery to secure it in place.



3. Plug the power adapter into the power outlet socket and then insert the power cable connector into the charger's power jack socket.



4. When the battery is fully charged, pry the battery from the corners as indicated to remove the battery from the charger.

The LED on the charger station will remain solid amber until the battery reaches fully charged. Once fully charged, the LED will turn off and the printer will automatically stop charging.



## 4.2.4 Charging the Printer with Battery Installed using the 1-Slot Docking Cradle (optional)



1. Slide to install the transfer adapter on the docking cradle.



2. Push the printer in the indicated direction ensuring that the slot on the rear side of the printer is aligned with transfer adapter.



3. Lay the printer on the cradle ensuring that the printer is secured in place and the terminals on the cradle is aligned with the docking socket on the printer.



4. Plug the power adapter into the power outlet socket and then insert the power cable connector into the charger's power jack socket.



5. Press the release button to release the printer from the docking cradle when fully charged.

The battery status LED on the printer will remain solid amber until the battery reaches fully charged. Once fully charged, the LED will turn off and the printer will automatically stop charging.

## 4.2.5 Charging the Printer with Battery Installed using the 4-Slot Docking Cradle (optional)



1. Place the docking cradle on a flat surface.



2. Place the holder for the printer on the docking cradle.



3. Install the single screw to secure the holder in place.



4. Install the printer on the docking cradle as indicated.



5. Plug the power adapter into the power outlet socket and then insert the power cable connector into the charger's power jack socket.



6. Turn on the power switch.

The battery status LED on the printer will remain solid amber until the battery reaches fully charged. Once fully charged, the LED will turn off and the printer will automatically stop charging.

## 4.3 Loading the Media



1. Press the media cover release button to open the media cover.

2. Slightly pull to separate the two media holders.



3. Load the media as illustrated ensuring that the hubs on the media holder fit into the media paper core. Pull out the media until the media extends out of the tear edge.

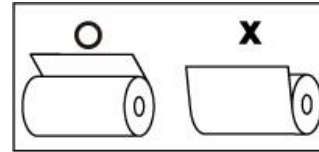

4. Close the media cover.
5. Use TSC Console to perform a calibration for the media in use.

**NOTE:** Performing a calibration is required when using other types of labels or loading a new media roll.

## 4.4 Loading the Linerless Media (Linerless Model)

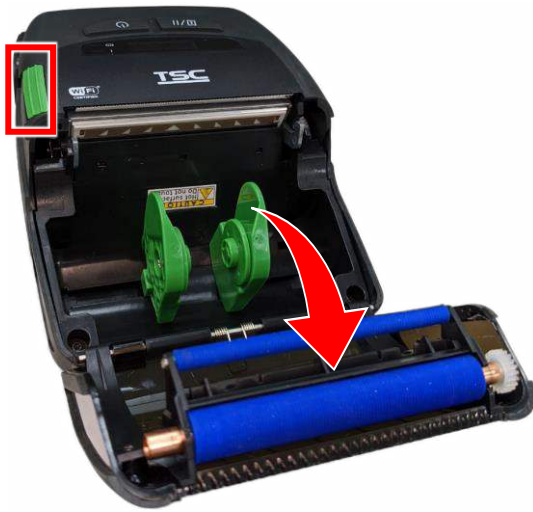

1. Press the media cover release button to open the media cover.



2. Slightly pull to separate the two media holders.

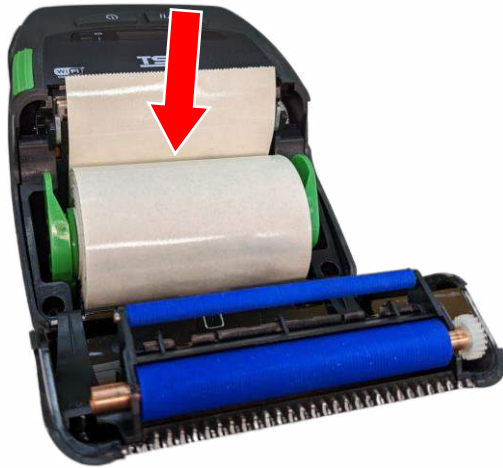

3. Load the media as illustrated ensuring that the hubs on the media holder fit into the media paper core. Pull out the media until the media extends out of the tear edge.

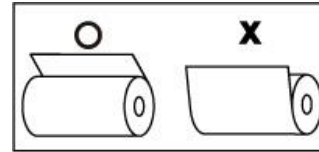

4. Close the media cover.
5. Use TSC Console to perform a calibration for the media in use.

**NOTE:** Performing a calibration is required when using other types of labels or loading a new media roll.

## 4.5 Installing the Belt Clip



1. Thread the belt clip through under the bar on the rear side of the printer.



2. Fold back to adhere the self-adhesive hook to the loop tape.



## 4.6 Using the IP54 Case with Shoulder Strap (optional)



1. Open the cover.



2. Put the printer into the case.



3. Close the cover.





4. Flip over the transparent cover and then attach the cover in place.

# 5 Operator Interface



No.	Name & Icon	Status	Description
1	LCD Monitor		<p>When connecting to a Wi-Fi network, the firmware version and Bluetooth information will disappear and give way to the Wi-Fi IP address.</p>
2	Feed / Pause Button 	<ul style="list-style-type: none"> <li>• When the printer is ready, press to feed one label.</li> <li>• When the printer is printing, press to pause the print activities. When the printer is in the pause state, press to resume the print activities.</li> </ul>	

No.	Name & Icon	Status	Description
3	Printer Status LED 	Off	The printer is turned on and ready.
		Green (blinking)	The system is downloading data from the computer or the printer is in pause state.
		Amber (solid)	The system is clearing data or the printer is busy.
		Red (solid)	The media cover is opened or there is memory error (memory space is not enough).
		Red (blinking)	Other errors, such as paper jam, paper empty
4	Battery Status LED 	Off	The battery is fully charged.
		Amber (blinking)	Battery overheat, cannot detect the battery, battery over-voltage, charge timeout, etc.
		Amber (solid)	The battery is charging.
5	Power Button 	<ul style="list-style-type: none"> <li>• When the printer is turned off, press and hold for 2 - 3 seconds to turn on the printer.</li> <li>• When the printer is on, press and hold for 2 - 3 seconds to turn off the printer.</li> </ul>	

# 6 TSC Console

Designed especially for the TSC printers, **TSC Console** enables users to deploy, manage, monitor, and troubleshoot both wired or wireless connections to one or a group of printers. **TSC Console** lowers IT costs and increases printer uptime with convenient out-of-the-box installation and a simplified Windows graphical user interface. It enhances robustness through integrated management capabilities and ensures that printers are available, reliable, and serviceable at all times.

## 6.1 Launching TSC Console

Follow the steps below to launch **TSC Console**:

1. Double click the **TSC Console** icon on the desktop of your computer to launch **TSC Console**. After launching **TSC Console**, the following screen will appear.

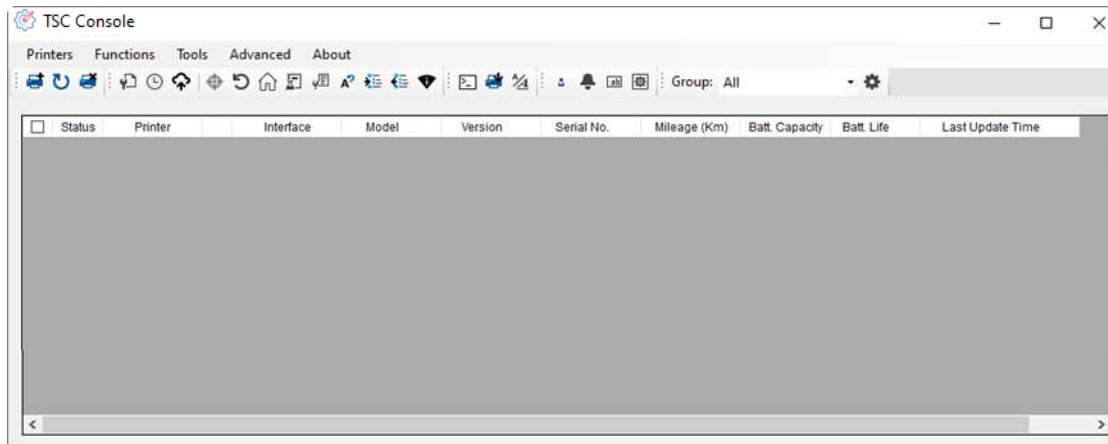

2. Select **Printers > Add Printers** to add the new printer to the **TSC Console** main page.

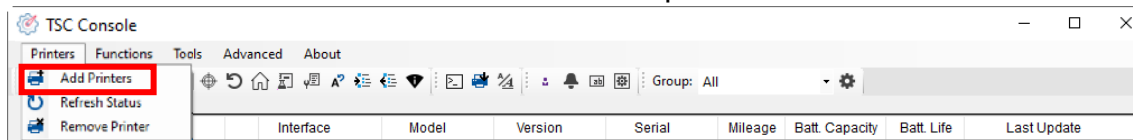

3. Select the connection based on how the printer is connected to your computer and then select **OK** to add the printer.  
**NOTE:** The image below shows that the printer is connected to a computer via the USB cable.

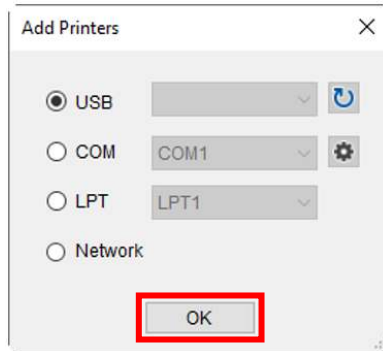

4. Select and start configuring the printer.

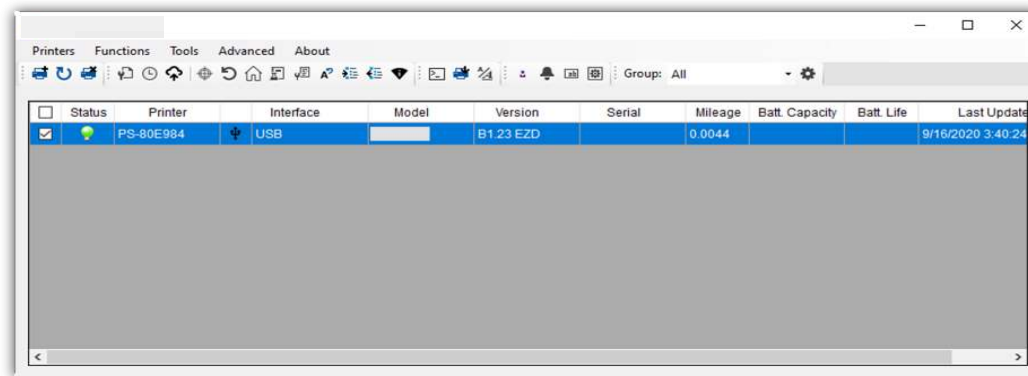

**NOTE:** You may refer to **TSC Console Programming Manual** for further information.

## 6.2 Adding Wi-Fi Interface

It allows users to add Wi-Fi interface to the **TSC Console** main page and enables users to control the printer through a wireless network. Follow the steps below to add Wi-Fi interface to the **TSC Console** main page:

1. Add the printer to the **TSC Console** main page via the USB port or COM port.
2. Double click the printer you want to configure to open the **Printer Configuration** page.

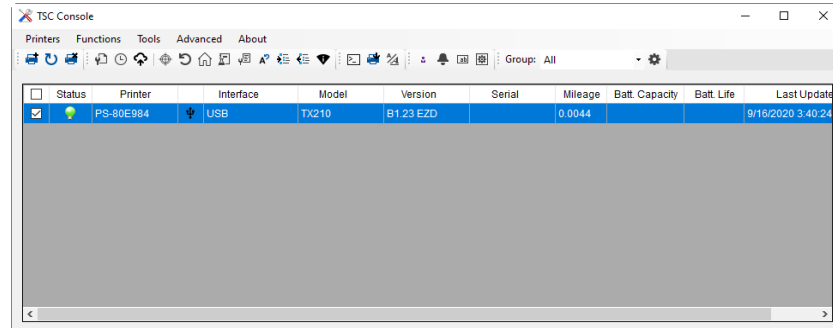

3. When the **Printer Configuration** page appear, select **Get** to retrieve the printer's information.
4. Select the **Wi-Fi** tab to open the configuration menu for Wi-Fi.

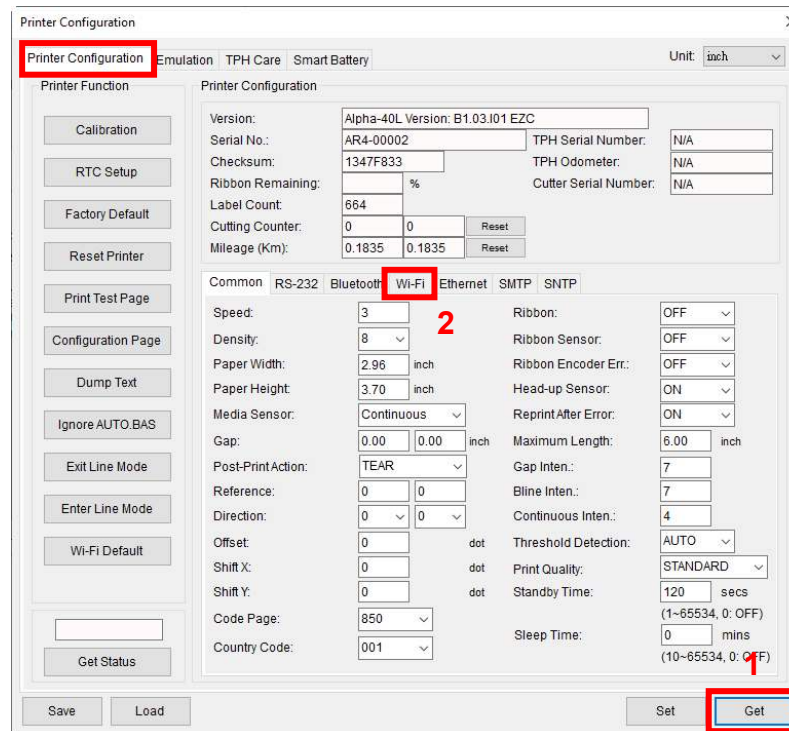

When using the WPA-Personal encryption:

- (1) Enter the network name in the **SSID** field.
- (2) Select **WPA-Personal** in the **WLAN Encryption** field.
- (3) Enter the Wi-Fi network password in the **Key** field.
- (4) Set **DHCP** to **ON**. If **DHCP** is set to **OFF**, you need to specify information for the **IP Address**, **Subnet Mask**, and **Gateway** fields.
- (5) Select **Set** to finish the configuration.

**NOTE:** The fields marked in yellow indicate that information in the fields have been changed before selecting **Set** to finish the configuration.

**NOTE:** Users are also allowed to change the name for the printer and raw port in the **Printer Name** field and **Raw Port** field.

The screenshot shows the 'Wi-Fi' configuration page. The 'Built-in Wi-Fi Module' section is active. The 'SSID' field contains 'SSID\_1', 'WLAN Encryption' is set to 'WPA-Personal', and the 'Key' field is filled with dots. The 'DHCP' dropdown is set to 'ON'. The 'Set' button at the bottom is highlighted with a red box and a red '2' next to it. Other fields like 'IP Address', 'Subnet Mask', and 'Gateway' are empty.

When using the WPA-Enterprise encryption:

- (1) Enter the network name in the **SSID** field.
- (2) Select **WPA-Enterprise** in the **WLAN Encryption** field.
- (3) Set **DHCP** to **ON**. If **DHCP** is set to **OFF**, you need to specify information for the **IP Address**, **Subnet Mask**, and **Gateway** fields.
- (4) Select EAP type in the **EAP Type** field.
- (5) Upload certificate and key for the **CA Certificate**, **Client Certificate**, and **Private Key** field respectively.
- (6) Select **Set** to finish the configuration.

**NOTE:** The fields marked in yellow indicate that information in the fields have been changed before selecting **Set** to finish the configuration.

**NOTE:** Users are also allowed to change the name for the printer and raw port in the **Printer Name** field and **Raw Port** field.

The screenshot shows the 'Wi-Fi' configuration page. The 'Built-in Wi-Fi Module' section is active. The 'SSID' field contains 'SSID\_2', 'WLAN Encryption' is set to 'WPA-Enterprise', and the 'Key' field is filled with dots. The 'DHCP' dropdown is set to 'ON'. The 'EAP Type' dropdown is set to 'EAP Type'. The 'Set' button at the bottom is highlighted with a red box and a red '3' next to it. Other fields like 'IP Address', 'Subnet Mask', and 'Gateway' are empty.

5. After selecting **Set** to finish the configuration, the message will appear on the screen and the printer will re-start automatically.

Please Wait



Please wait as this may take a few seconds...

6. After the printer re-starts, the printer's IP address, the Wi-Fi icon, and the Wi-Fi's address will appear on the printer's display.

**NOTE:** The printer's IP address should appear on the printer's display in from 5 to 15 seconds after the printer re-starts. If the IP address does not appear, initialize the printer's Wi-Fi module and then re-configure the Wi-Fi connection.

7. Remove the interface cable.

8. Go to the **TSC Console** main page, select **Printers > Add Printers** and then select **Network** to add the printer.

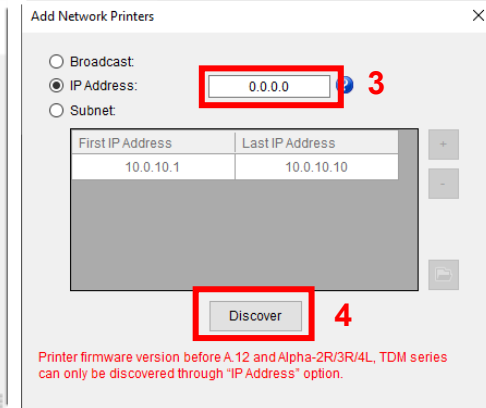
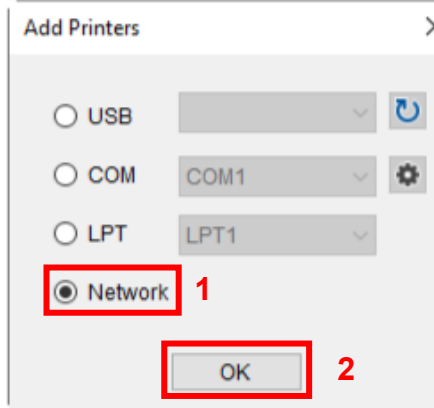



9. Go to the **TSC Console** main page.
10. Select and then double click the printer.
11. Select **Functions > Print Test Page** to check if you can print the test page via the Wi-Fi connection.

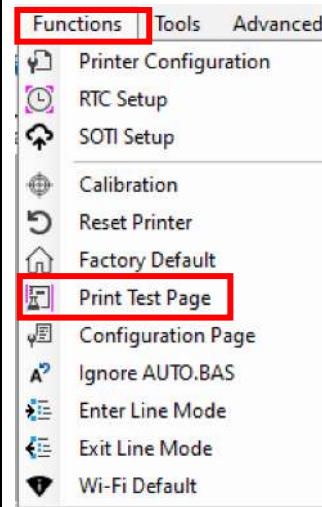

## 6.3 Configuring Bluetooth

Follow the steps below to configure Bluetooth for your printer:

1. Add the printer to the **TSC Console** main page via the USB port or COM port. For how to add the printer to the **TSC Console** main page, please refer to Launching TSC Console.
2. Double click the printer you want to configure to open the **Printer Configuration** page.



3. Select the **Bluetooth** tab. Press the **Get** button to read the Bluetooth configuration.

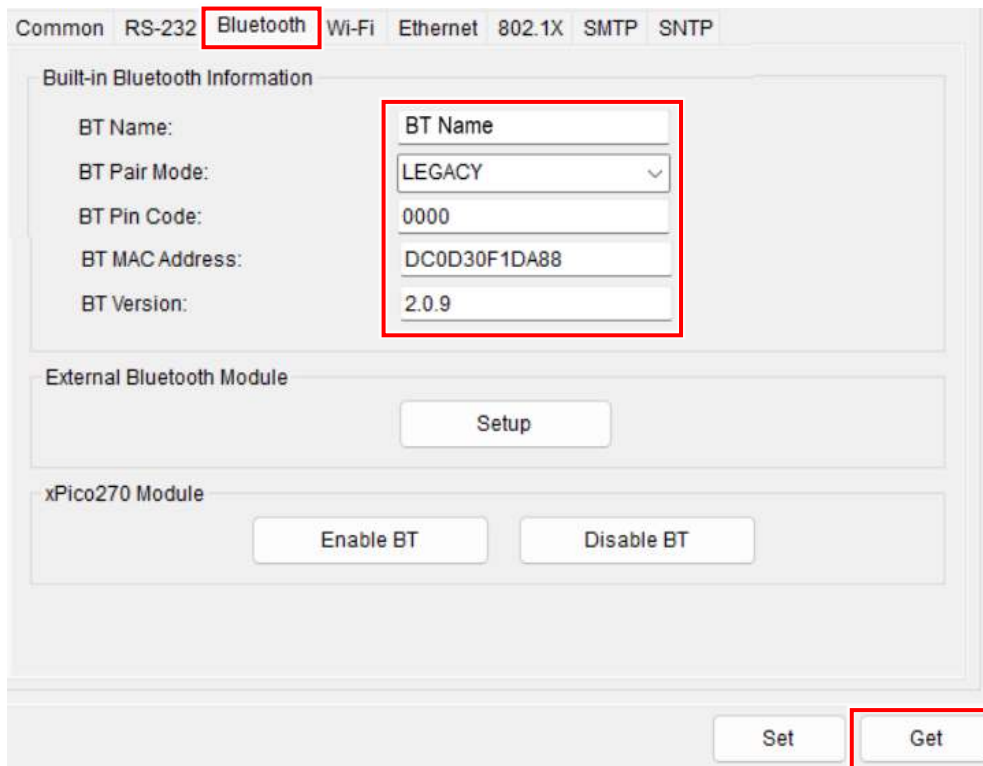

4. Enter the new Bluetooth local name or Bluetooth PIN code in the field. The field will be marked in yellow when the value is revised.
5. Press the **Set** button to set the new Bluetooth name or Bluetooth PIN code.  
Press the **Get** button to confirm that the new settings have been correctly written into the printer.

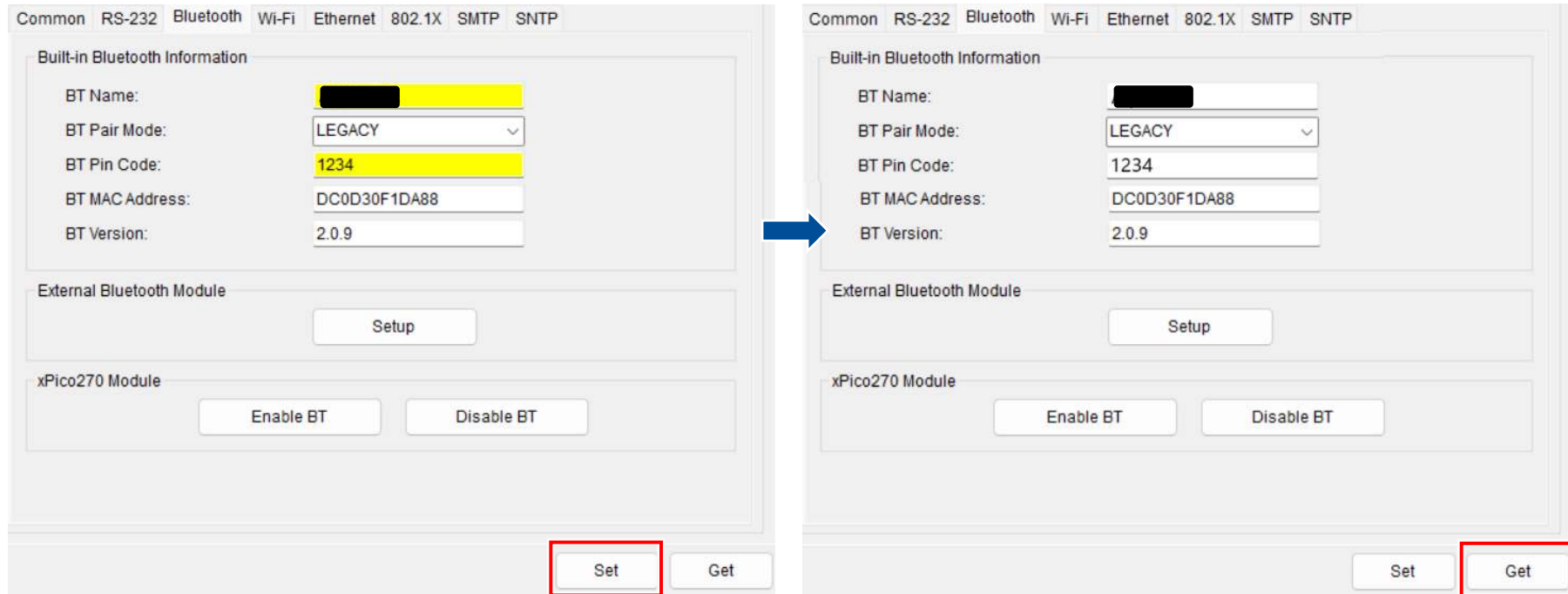

## 6.4 Initializing Printer's Wi-Fi Settings

1. Go to the **TSC Console** main page.
2. Select the **Functions** tab.

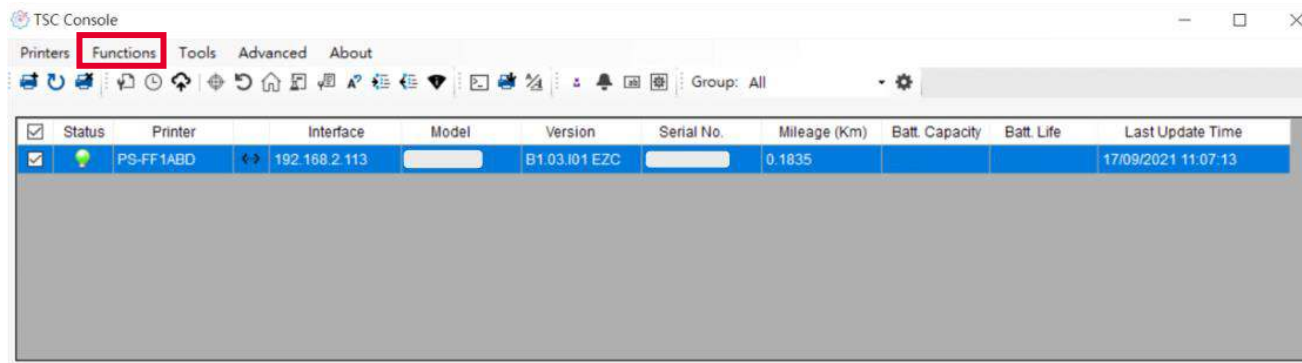

3. Select **Wi-Fi Default** to restore the Wi-Fi settings to factory default values.

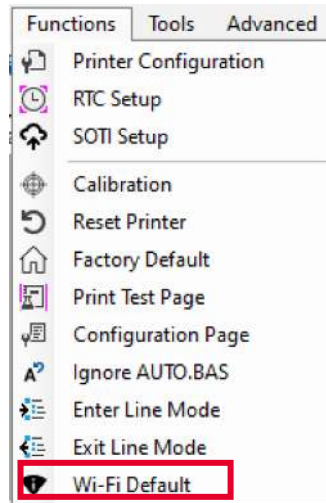

## 6.5 TPH Care

Self-Diagnostic TPH Care allows users to scan and detect defective dots on the printhead during the printing process. It helps reduce downtime, prevent faulty labels, and avoid barcodes of poor quality on mission critical tasks.

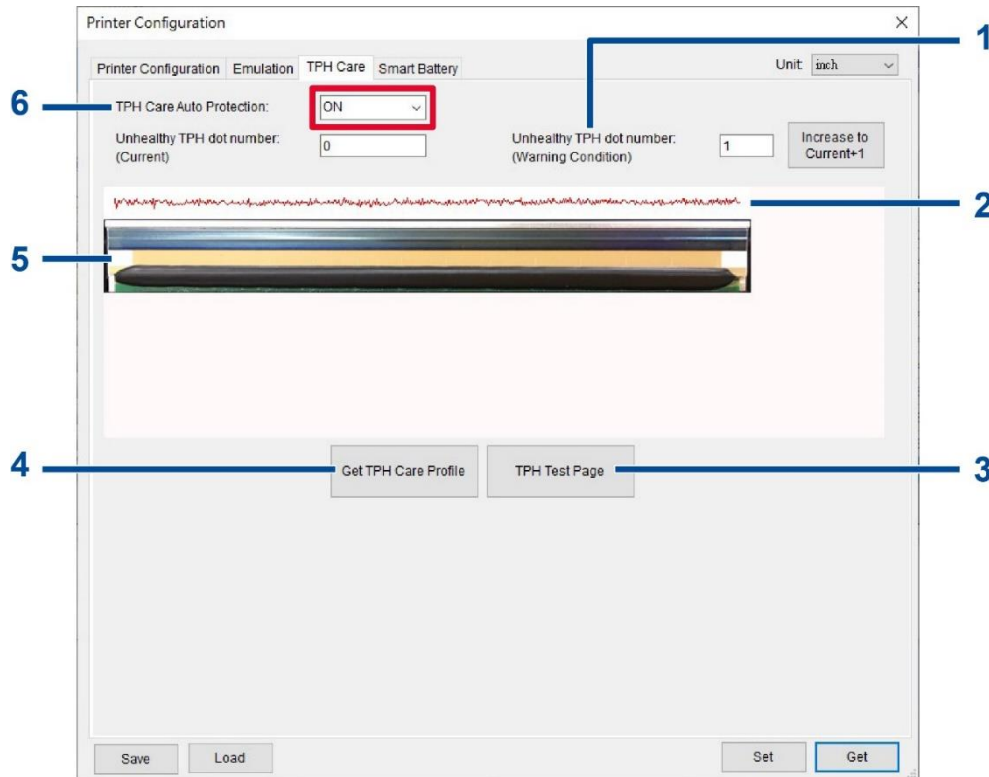

1. Sets the reminder that the defective dots have reached the configured numbers.
2. Shows the difference between the defective dots and the average of all other good dots in the series. The surge indicates that it is very likely that the dots in the corresponding area on the printhead are defective.
3. Prints the test page so that users can check the health status of the printhead.
4. Detects the defective dots on the printhead.
5. Allows users to check if there are defective dots on the printhead.
6. Enables/Disables **TPH Care Auto Protection**.

Follow the steps below to open the **TPH Care** page:

1. Double click the printer you want to configure on the **TSC Console** main page to open the **Printer Configuration** menu.

2. Select the **TPH Care** tab to enter the **TPH Care** page.

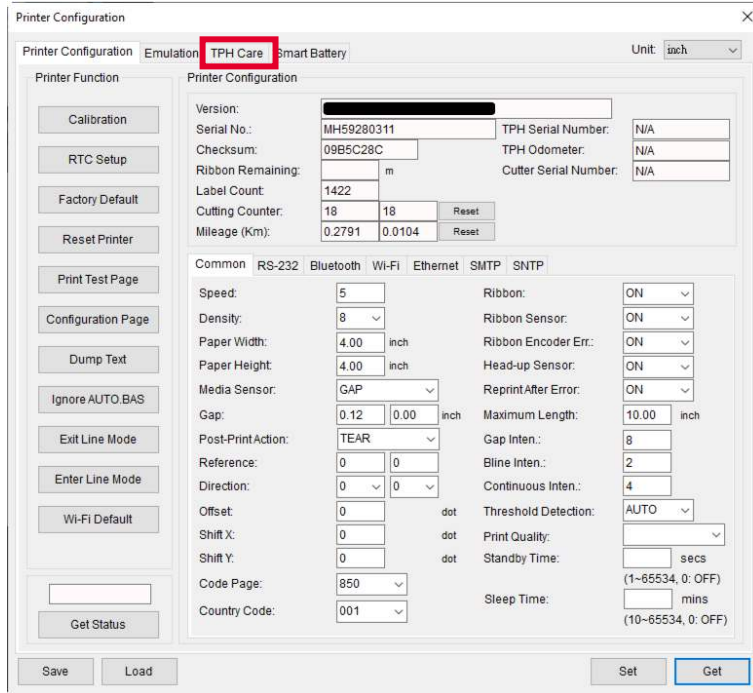

3. Enable the **TPH Care Auto Protection** function (Default: **OFF**).

4. Select **Get TPH Care Profile** to check the health status of the printhead.

If the pattern extends flat roughly, it means the status of the printhead is good. Alternatively, you can check the **Unhealthy TPH dot number** field. If the unhealthy dot number is 0, it means that the status of the printhead is good.

If surges or spikes appear as the following image, it is very likely that there are defective dots in the corresponding area on the printhead. The printer will stop printing.

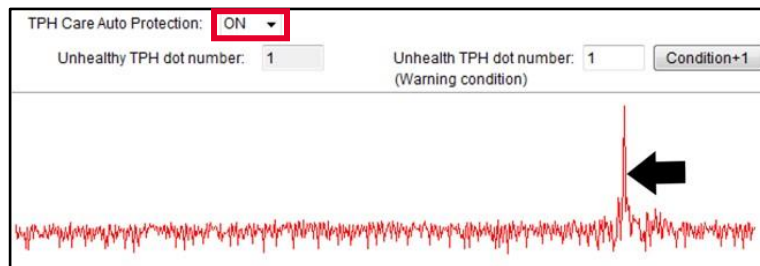

# 6.6 Printer's Main Functions

The function buttons are located on the left side of the **Printer Configuration** page. You can use the function buttons to manage and configure the printer.

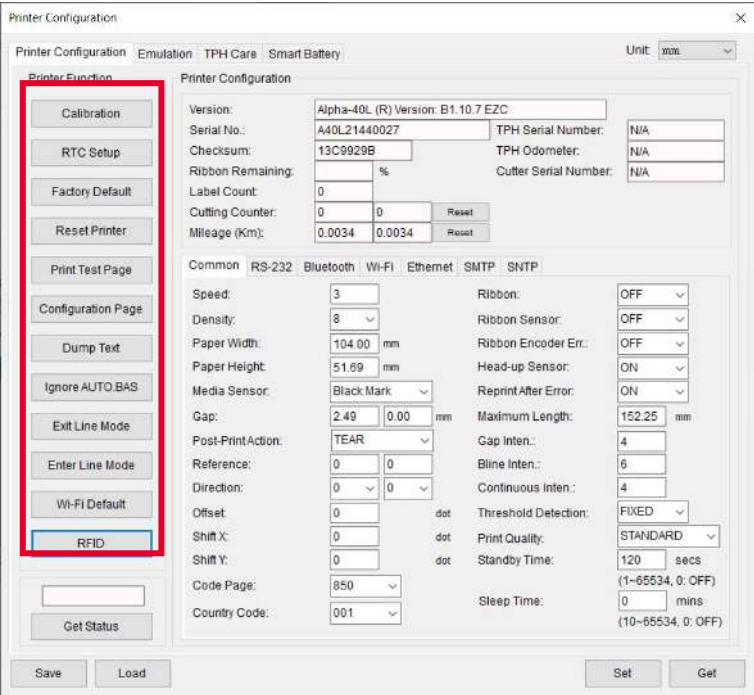

Item	Description
<b>Calibration</b>	Detects the media type and label size.
<b>RTC Setup</b>	Synchronizes the printer with the real time clock on the computer.
<b>Factory Default</b>	Restores the printer's settings to factory default values.
<b>Reset Printer</b>	Re-starts the printer.
<b>Print Test Page</b>	Prints test page based on the specified label size and sensor type.
<b>Configuration Page</b>	Prints the printer's configurations.
<b>Dump Text</b>	Activates Dump Mode.
<b>Ignore AUTO BAS</b>	Ignores the AUTO BAS file when the printer boots up.
<b>Exit Line Mode</b>	The printer will leave line mode and enter page mode.
<b>Enter Line Mode</b>	The printer will leave page mode and enter line mode.
<b>Wi-Fi Default</b>	Restores the Wi-Fi settings to factory default values.

## 6.7 Configuring Optional Kits

If you install an optional kit on the printer, such as cutter, peeler, or media rewinder, you need to configure the kit after finishing the calibration so that the kit works properly.

To configure the kit:

1. Add the printer to the **TSC Console** main page via the USB port or COM port.
2. Set up the wired or wireless connection between the printer and your computer.
3. Double click the printer you want to configure on the **TSC Console** main page to enter the **Printer Configuration** page.
4. Select **Get** to get printer's information.
5. Select the **Common** tab.
6. In the drop-down list for the **Post-Print Action** field, select the corresponding item based on what kind of kit you have installed on the printer.
7. Select **Set** to finish the configuration.

Printer Configuration

Printer Configuration Emulation TPH Care Smart Battery Unit: mm

Printer Function

Calibration  
RTC Setup  
Factory Default  
Reset Printer  
Print Test Page  
Configuration Page  
Dump Text  
Ignore AUTO.BAS  
Exit Line Mode  
Enter Line Mode  
Wi-Fi Default  
RFID  
Get Status

Printer Configuration

Version: MB240 Version: A2.15.G03 EZD TCF  
Serial No.: A1  
Checksum: 126ADDB1  
Ribbon Remaining: m  
Label Count: 851  
Cutting Counter: 61 61  
Mileage (Km): 0.1415 0.1415

TPH Serial Number: RDL29700523  
TPH Odometer: 0.0893  
Cutter Serial Number: N/A

Common RS-232 Bluetooth Wi-Fi Ethernet 802.1X SMTP SNTIP

Speed: 2  
Density: 8  
Paper Width: 101.60 mm  
Paper Height: 101.60 mm  
Media Sensor: Continuous  
Gap: 0.00 0.00 mm  
Post-Print Action: TEAR  
Reference:  
Direction:  
Offset:  
Shift X:  
Shift Y:  
Code Page: 850  
Country Code: 001

Ribbon: ON  
Ribbon Sensor: ON  
Ribbon Encoder Err.: ON  
Head-up Sensor: ON  
Reprint After Error: ON  
Maximum Length: 254.00 mm  
Gap Inten.: 8  
Blint Inten.: 2  
Continuous Inten.: 4  
Threshold Detection: AUTO  
Print Quality:  
Standby Time: secs  
(1~65534, 0: OFF)  
Sleep Time: mins  
(10~65534, 0: OFF)

Save Load Set Get



## 6.8 Smart Battery (Mobile Printers only)

The **Smart Battery** page shows the battery status for the mobile printers.

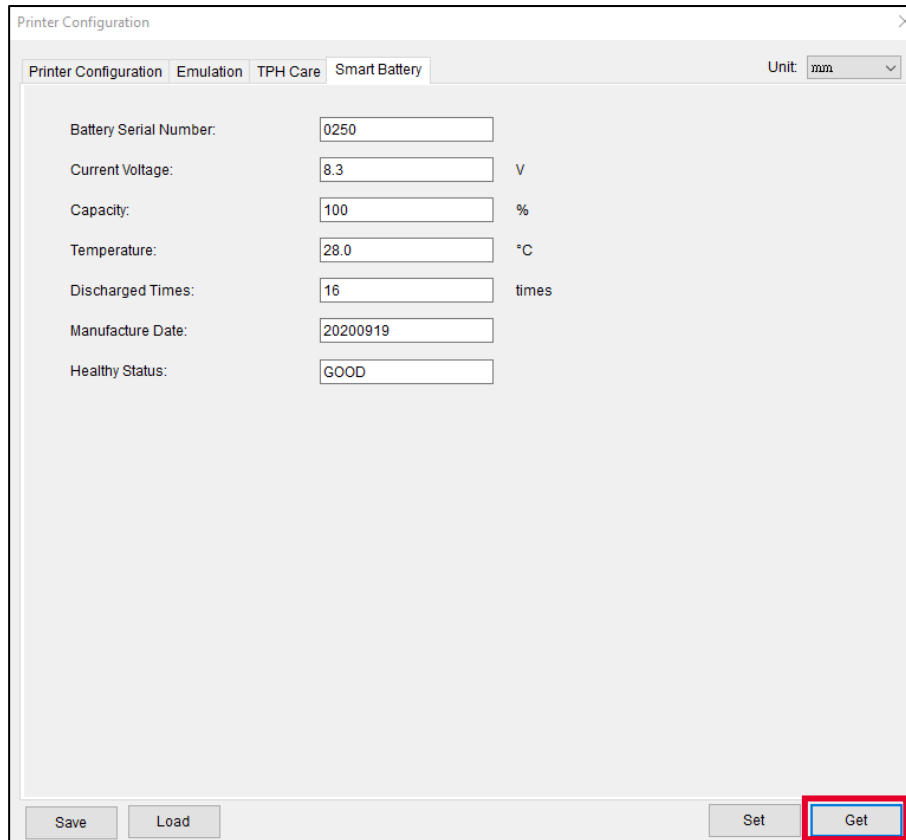

The screenshot shows a 'Printer Configuration' dialog box with a 'Smart Battery' tab selected. The dialog has a title bar with a close button (X) and a 'Unit' dropdown menu set to 'mm'. The main area contains several input fields for battery-related data. At the bottom, there are four buttons: 'Save', 'Load', 'Set', and 'Get'. The 'Get' button is highlighted with a red rectangle.

Field	Value	Unit
Battery Serial Number:	0250	
Current Voltage:	8.3	V
Capacity:	100	%
Temperature:	28.0	°C
Discharged Times:	16	times
Manufacture Date:	20200919	
Healthy Status:	GOOD	

Buttons: Save, Load, Set, Get

# 7 Troubleshooting

Problem	Possible Cause	Recovery Procedure
Power indicator or display does not illuminate.	<ul style="list-style-type: none"> <li>▪ The battery is not properly installed.</li> <li>▪ No power.</li> </ul>	<ul style="list-style-type: none"> <li>▪ Re-install the battery.</li> <li>▪ Recharge or replace battery as necessary.</li> </ul>
The printer has no response.	<ul style="list-style-type: none"> <li>▪ The interface cable is not connected to the interface port.</li> <li>▪ The host device and printer is not connected via the Wi-Fi network or Bluetooth.</li> <li>▪ The port specified in the Windows driver is not correct</li> </ul>	<ul style="list-style-type: none"> <li>▪ Re-connect the interface cable or try another interface cable.</li> <li>▪ Re-configure the Wi-Fi network or Bluetooth and connect again.</li> <li>▪ Select correct port in the driver.</li> <li>▪ Check your program ensuring that you enter the PRINT command at the end of the file and there must be CRLF at the end of each command line.</li> </ul>
The printer prints blank labels.	<ul style="list-style-type: none"> <li>▪ The media roll is not loaded correctly.</li> <li>▪ The media type is not correct.</li> </ul>	<ul style="list-style-type: none"> <li>▪ Follow the instructions to re-load the media roll.</li> <li>▪ Use thermal type paper.</li> </ul>
“Carriage Open” appears on the display.	The media cover is open.	Close the media cover.
“Out of Paper” appears on the display.	<ul style="list-style-type: none"> <li>▪ Media is used up.</li> <li>▪ The media roll is not properly installed.</li> <li>▪ Black mark sensor is not calibrated.</li> </ul>	<ul style="list-style-type: none"> <li>▪ Install a new media roll.</li> <li>▪ Re-install the media roll.</li> <li>▪ Calibrate the black mark sensor.</li> </ul>
“Paper Jam” appears on the display.	<ul style="list-style-type: none"> <li>▪ Gap sensor or black mark sensor is not correctly configured.</li> <li>▪ Media size is not correct.</li> <li>▪ Labels may be stuck in the printhead mechanism.</li> </ul>	<ul style="list-style-type: none"> <li>▪ Calibrate the black mark sensor.</li> <li>▪ Check if the media in use is applicable.</li> <li>▪ Check if the printhead mechanism is clear of labels.</li> </ul>
I cannot download files to printer’s memory (FLASH / SD card).	<ul style="list-style-type: none"> <li>▪ The FLASH memory or SD card is full.</li> <li>▪ The SD card is damaged.</li> <li>▪ SD card is not correctly inserted.</li> </ul>	<ul style="list-style-type: none"> <li>▪ Delete files you do not need from the FLASH memory or SD card.</li> <li>▪ Eject and insert the SD card again.</li> <li>▪ Try another SD card.</li> <li>▪ Check if the SD card is in supported format and capacity.</li> </ul>

Problem	Possible Cause	Recovery Procedure
Poor Print Quality	<ul style="list-style-type: none"> <li>▪ Media is not loaded correctly.</li> <li>▪ Dust or adhesive accumulation on the printhead.</li> <li>▪ Print density is not properly configured.</li> <li>▪ Media type is not compatible.</li> <li>▪ Printhead element is damaged.</li> </ul>	<ul style="list-style-type: none"> <li>▪ Reload the media.</li> <li>▪ Clean the printhead and platen roller.</li> <li>▪ Adjust the print density and print speed.</li> <li>▪ Run printer self-test and check the printhead test pattern if there is dot missing in the pattern.</li> <li>▪ Use proper media type.</li> </ul>
Missing printing on the left or right side of label	Wrong label size configuration	Set the correct label size.
Gray line on the blank label	<ul style="list-style-type: none"> <li>▪ The printhead is dirty.</li> <li>▪ The platen roller is dirty.</li> </ul>	<ul style="list-style-type: none"> <li>▪ Clean the printhead.</li> <li>▪ Clean the platen roller.</li> </ul>
Irregular printing	The printer is in Hex Dump mode.	Turn off and on the printer to skip the dump mode.
Skip labels when printing	<ul style="list-style-type: none"> <li>▪ The label size is not properly configured.</li> <li>▪ Sensor is not configured properly.</li> <li>▪ The media sensor is dirty.</li> </ul>	<ul style="list-style-type: none"> <li>• Check if the label size is correct.</li> <li>• Calibrate the sensor using Auto Gap or Manual Gap options.</li> <li>• Clean media sensor using a blower.</li> </ul>
RTC time is not correct when rebooting the printer.	The RTC battery has no power.	Check the RTC battery.

# 8 Maintenance

This section provides cleaning and maintenance procedures.

## **Cleaning:**

Depending on the media used, the printer may accumulate residues (media dust, adhesives, etc.) as a by-product of normal printing. To maintain the best printing quality, you should remove these residues by cleaning the printer periodically. Regularly clean the print head and supply sensors once change a new media to keep the printer at the optimized performance and extend printer life.

## **Disinfecting:**

Disinfecting the printer helps protect yourself and other users and helps prevent virus from spreading.

## **IMPORTANT:**

- Set the printer power switch to O (Off) prior to performing any cleaning or disinfecting tasks. Leave the power cord connected to keep the printer grounded and to reduce the risk of electrostatic damage.
- Do not wear rings or other metallic objects while cleaning any interior area of the printer.
- Use only the cleaning agents recommended in this document. Use of other agents may damage the printer and void its warranty.
- Do not spray or drip liquid cleaning solutions directly into the printer. Apply the solution on a clean lint-free cloth and then apply the dampened cloth to the printer.
- Do not use canned air in the interior of the printer as it can blow dust and debris onto sensors and other critical components.
- Only use a vacuum cleaner with a nozzle and hose that are conductive and grounded to drain off static build up.
- All reference in these procedures for use of isopropyl alcohol requires that a 99% or greater isopropyl alcohol content be used to reduce the risk of moisture corrosion to the printhead.
- Do not touch printhead by hand. If you touch it carelessly, please use 99% Isopropyl alcohol to clean it.
- Always taking personal precaution when using any cleaning agent.

## 8.1 Cleaning Supplies

The following supplies are recommended for cleaning the printer:

- Cotton swab
- Lint-free cloth
- Brush with soft and non-metallic bristles
- Vacuum cleaner
- 75% Ethanol used for disinfection
- 99% Isopropyl alcohol used for cleaning the printhead and platen roller
- Genuine printhead cleaning pens
- Chlorine free detergents

## 8.2 Cleaning Procedures

Component	Method	Recommended Cleaning Schedule
<b>Printhead</b>	<ol style="list-style-type: none"> <li>1. Power off the printer before cleaning the printhead.</li> <li>2. Leave the printhead to cool down for at least one minute.</li> <li>3. Wet a cotton swab with the 99% Isopropyl alcohol and then wipe across the printhead head. You can also use the genuine printhead cleaning pen to clean the printhead.</li> </ol>	Clean the printhead when you load new media.
<b>Platen Roller</b>	<ol style="list-style-type: none"> <li>1. Power off the printer.</li> <li>2. Use a piece of 99% Isopropyl alcohol saturated lint-free cloth to wipe the platen roller while rotating the platen roller.</li> </ol>	Clean the platen roller when you load new media.
<b>Peel Bar</b>	Use a piece of 99% Isopropyl alcohol saturated lint-free cloth to wipe the peel bar.	Clean as needed.
<b>Sensor</b>	Use the brush with soft and non-metallic bristles or vacuum cleaner to remove the dust or particles in order to optimize the print quality or sensor calibration.	Clean the sensor monthly.
<b>Exterior</b>	Use a piece of water-dampened lint-free cloth to wipe the surface. If necessary, you can apply the chlorine free detergent. After finishing cleaning, use the 75% ethanol to disinfect the surface.	Clean as needed.
<b>Interior</b>	Use the brush with soft and non-metallic bristles or vacuum cleaner to remove the dust or particles. After finishing cleaning, use the 75% ethanol to disinfect the interior.	Clean as needed.

## 9 Agency Compliance and Approvals



EN 55032, Class B

EN 55035

EN IEC 61000-3-2

EN 61000-3-3

EN 62368-1



FCC part 15B, Class B

ICES-003, Class B

This equipment has been tested and found to comply with the limits for a Class B digital device, pursuant to part 15 of the FCC Rules. These limits are designed to provide reasonable protection against harmful interference in a residential installation. This equipment generates, uses and can radiate radio frequency energy and, if not installed and used in accordance with the instructions, may cause harmful interference to radio communications. However, there is no guarantee that interference will not occur in a particular installation. If this equipment does cause harmful interference to radio or television reception, which can be determined by turning the equipment off and on, the user is encouraged to try to correct the interference by one or more of the following measures:

- Reorient or relocate the receiving antenna.
- Increase the separation between the equipment and receiver.
- Connect the equipment into an outlet on a circuit different from that to which the receiver is connected.
- Consult the dealer or an experienced radio/ TV technician for help.

This device complies with Part 15 of the FCC Rules. Operation is subject to the following two conditions:(1) This device may cause harmful interference, and (2) this device must accept any interference received, including interference that may cause undesired operation.

**This Class B digital apparatus complies with Canadian ICES-003**

**Cet appareil numérique de la classe B est conforme à la norme NMB-003 du Canada**



AS/NZS CISPR 32, Class B



GB 4943.1  
GB/T9254  
GB 17625.1



IS 13252(Part 1)/  
IEC 60950-1



TP TC 004  
TP TC 020



LP0002



TELEC-T401  
Japanese radio regulation 2008



K 60950-1  
KS C 9832:2019  
KS C 9835:2019  
KS X 3124:2020  
KS X 3126:2020



CNS 13438  
CNS 14336-1



NBTC



เครื่องวิทยุคมนาคมนี้ ได้รับยกเว้น ไม่ต้องได้รับ  
ใบอนุญาตให้มี ใช้งานเครื่องวิทยุคมนาคม  
หรือตั้งสถานีวิทยุคมนาคมตามประกาศ กสทช.  
เรื่อง เครื่องวิทยุคมนาคม และสถานีวิทยุ  
คมนาคมที่ได้รับยกเว้นไม่ต้องได้รับใบอนุญาต  
วิทยุคมนาคม ตามพระราชบัญญัติวิทยุ  
คมนาคม พ.ศ. 2498



**nabp.** | โทรคมนาคม  
กำกับดูแลเพื่อประชาชน  
Call Center 1200 ( Insw5 )



เครื่องวิทยุคมนาคมนี้ ได้รับยกเว้น ไม่ต้องได้รับ  
ใบอนุญาตให้มี ใช้งานเครื่องวิทยุคมนาคม  
หรือตั้งสถานีวิทยุคมนาคมตามประกาศ กสทช.  
เรื่อง เครื่องวิทยุคมนาคม และสถานีวิทยุ  
คมนาคมที่ได้รับยกเว้นไม่ต้องได้รับใบอนุญาต  
วิทยุคมนาคม ตามพระราชบัญญัติวิทยุ  
คมนาคม พ.ศ. 2498



**nabp.** | โทรคมนาคม  
กำกับดูแลเพื่อประชาชน  
Call Center 1200 ( Insw5 )



VCCI-TECHNICAL REQUIREMENTS (VCCI-CISPR 32:2016)  
CISPR 32:2015+COR1:2016

SDPPI



มีการเปลี่ยนแปลงข้อกำหนด สมรรถนะซึ่งอาจ  
เพิ่มความเสี่ยงของผลกระทบต่อสุขภาพของมนุษย์  
ที่อาจเกิดขึ้นได้

80657/SDPPI/2022

12529

**WPC**

45 (E) Dated 28-01-2005  
1048 (E) Dated 18-10-2018



NTC

Complies with  
IMDA Standards  
[Dealer's Licence No.]

IMDA TS SRD

**UK  
CA**

BS EN 55032  
BS EN IEC 61000-3-2  
BS EN 61000-3-3  
BS EN 55035

備註：不同型號可能會有不同認證，一切以產品上的認證標籤為準。

## Important safety instructions:

1. Read all of these instructions and keep them for later use.
2. Follow all warnings and instructions on the product.
3. Disconnect the power plug from the AC outlet before cleaning or if fault happened.  
Do not use liquid or aerosol cleaners. Using a damp cloth is suitable for cleaning.
4. The mains socket shall be installed near the equipment and easily accessible.
5. The unit must be protected against moisture.
6. Ensure the stability when installing the device, Tipping or dropping could cause damage.
7. Make sure to follow the correct power rating and power type indicated on marking label provided by manufacture.
8. Please refer to user manual for maximum operation ambient temperature.



### **WARNING:**

Hazardous moving parts, keep fingers and other body parts away.

### **CAUTION:**

Risk of explosion if battery is replaced by an incorrect type.

Dispose of used batteries according to the Instructions as below.

1. DO NOT throw the battery in fire.
2. DO NOT short circuit the contacts.
3. DO NOT disassemble the battery.
4. DO NOT throw the battery in municipal waste.
5. The symbol of the crossed out wheeled bin indicates that the battery should not be placed in municipal waste.

### 電池安全警告：

- ⊙ 勿將電池扔於火中。
- ⊙ 勿將電池接點短路。
- ⊙ 不可拆解電池。
- ⊙ 不亂將電池當成一般廢棄物處理。
- ⊙ 打叉的垃圾桶符號表示電池不應該被放置到一般廢棄堆中。

### 注意：

- ⊙ 更換不正確型號類型的電池，將產生爆炸危險。
- ⊙ 請根據使用說明處理用過的電池。

### 鋰電安全使用指南：

注意：電池若未正確更換，可能會爆炸。請用原廠建議之同款或同等級的電池來更換。請依原廠指示處理廢棄電池。



### CAUTION:

The printhead may be hot and could cause severe burns. Allow the printhead to cool.

### CAUTION:

Any changes or modifications not expressly approved by the grantee of this device could void the user's authority to operate the equipment.

**CE Statement:**

This equipment complies with EU radiation exposure limits set forth for an uncontrolled environment. This equipment should be installed and operated with minimum distance 20 cm between the radiator & your body.

All operational modes:

2.4GHz: 802.11b, 802.11g, 802.11n (HT20), 802.11n (HT40)

5GHz: 802.11a,

The frequency, mode and the maximum transmitted power in EU are listed below:

2400 MHz – 2483.5 MHz: 19.88 dBm (EIRP)

5150 MHz – 5250 MHz: 17.51 dBm (EIRP)

5150-5350MHz for Only indoor use

5470-5725MHz for indoor/outdoor use

## Restrictions In AZE

National restrictions information is provided below

Frequency Band	Country	Remark
5150-5350MHz	Azerbaijan	No license needed if used indoor and power not exceeding 30mW
5470-5725MHz		

Hereby, TSC Auto ID Technology Co., Ltd. declares that the radio equipment type [Wi-Fi] IEEE 802.11 a/b/g/n is in compliance with Directive 2014/53/EU

The full text of the EU declaration of conformity is available at the following internet address: [http:// www.tscprinters.com](http://www.tscprinters.com)

### **RF exposure warning (Wi-Fi)**

This equipment must be installed and operated in accordance with provided instructions and must not be co-located or operating in conjunction with any other antenna or transmitter. End-users and installers must be providing with antenna installation instructions and transmitter operating conditions for satisfying RF exposure compliance.

SAR Value: 0.736 W/kg

### **RF exposure warning (For Bluetooth)**

The equipment complies with FCC RF exposure limits set forth for an uncontrolled environment.

The equipment must not be co-located or operating in conjunction with any other antenna or transmitter.

## **Canada, Industry Canada (IC) Notices**

This Class B digital apparatus complies with Canadian ICES-003 and RSS-210.

Operation is subject to the following two conditions: (1) this device may not cause interference, and (2) this device must accept any interference, including interference that may cause undesired operation of the device.

## **Radio Frequency (RF) Exposure Information**

The radiated output power of the Wireless Device is below the Industry Canada (IC) radio frequency exposure limits. The Wireless Device should be used in such a manner such that the potential for human contact during normal operation is minimized.

This device has been evaluated for and shown compliant with the IC Specific Absorption Rate (“SAR”) limits when installed in specific host products operated in portable exposure conditions. **(For Wi-Fi)**

This device has also been evaluated and shown compliant with the IC RF Exposure limits under portable exposure conditions. (Antennas are less than 20 cm of a person's body). **(For Bluetooth)**

## **Canada, avis de l'Industry Canada (IC)**

Cet appareil numérique de classe B est conforme aux normes canadiennes ICES-003 et RSS-210.

Son fonctionnement est soumis aux deux conditions suivantes : (1) cet appareil ne doit pas causer d'interférence et (2) cet appareil doit accepter toute interférence, notamment les interférences qui peuvent affecter son fonctionnement.

## Informations concernant l'exposition aux fréquences radio (RF)

La puissance de sortie émise par l'appareil sans fil est inférieure à la limite d'exposition aux fréquences radio de l'Industry Canada (IC). Utilisez l'appareil sans fil de façon à minimiser les contacts humains lors du fonctionnement normal.

Ce périphérique a été évalué et démontré conforme aux limites SAR (Specific Absorption Rate – Taux d'absorption spécifique) par l'IC lorsqu'il est connecté à des dispositifs hôtes spécifiques opérant dans des conditions d'utilisation mobile. **(Pour le Wi-Fi)**

Ce périphérique a également été évalué et démontré conforme aux limites d'exposition radio-fréquence par l'IC pour des utilisations par des opérateurs mobiles (les antennes sont à moins de 20 cm du corps d'une personne). **(Pour le Bluetooth)**

## NCC 警語

經型式認證合格之低功率射頻電機，非經許可，公司、商號或使用者均不得擅自變更頻率、加大功率或變更原設計之特性及功能。(即低功率電波輻射性電機管理辦法第十二條)

低功率射頻電機之使用不得影響飛航安全及干擾合法通信；經發現有干擾現象時，應立即停用，並改善至無干擾時方得繼續使用。

前項合法通信，指依電信法規定作業之無線電通信。低功率射頻電機須忍受合法通信或工業、科學及醫療用電波輻射性電機設備之干擾。(即低功率電波輻射性電機管理辦法第十四條)



單元 Unit	限用物質及其化學符號 Restricted substances and its chemical symbols					
	鉛 Lead (Pb)	汞 Mercury (Hg)	鎘 Cadmium (Cd)	六價鉻 Hexavalent chromium (Cr+6)	多溴聯苯 Polybrominated biphenyls (PBB)	多溴二苯醚 Polybrominated diphenyl ethers (PBDE)
內外塑膠件	○	○	○	○	○	○
內外鐵件	-	○	○	○	○	○
滾輪	○	○	○	○	○	○
銘版	○	○	○	○	○	○
電路板	-	○	○	○	○	○
晶片電阻	-	○	○	○	○	○
積層陶瓷表面黏著電容	○	○	○	○	○	○
集成電路-IC	-	○	○	○	○	○
電源供應器	○	○	○	○	○	○
印字頭	-	○	○	○	○	○
馬達	-	○	○	○	○	○
液晶顯示器	-	○	○	○	○	○
插座	-	○	○	○	○	○
線材	-	○	○	○	○	○

備考 1. “超出 0.1 wt %” 及 “超出 0.01 wt %” 係指限用物質之百分比含量超出百分比含量基準值。

Note 1: “Exceeding 0.1 wt %” and “exceeding 0.01 wt %” indicate that the percentage content of the restricted substance exceeds the reference percentage value of presence condition.

備考 2. “○” 係指該項限用物質之百分比含量未超出百分比含量基準值。

Note 2: “○” indicates that the percentage content of the restricted substance does not exceed the percentage of reference value of presence.

備考 3. “-” 係指該項限用物質為排除項目。

Note 3: The “-” indicates that the restricted substance corresponds to the exemption.

# Revision History

Date	Description	Technical Writer
2023/11/15	Official release.	Peter Yao
2024/01/18	<ul style="list-style-type: none"><li>Revised format and layout</li><li>Updated the specifications from page 5 to 7.</li></ul>	Peter Yao



[www.tscprinters.com](http://www.tscprinters.com)