



*Industrial Barcode Printer*

# TTP-286MT Series

*Thermal Transfer • Direct Thermal*

## **Series Models**

*TTP-286MT / TTP-384MT*

# Copyright

**©2015 TSC Auto ID Technology Co., Ltd.**

The copyright in this manual, the software and firmware in the printer described are owned by TSC Auto ID Technology Co., Ltd. All rights reserved.

CG Triumvirate is a trademark of Agfa Corporation. CG Triumvirate Bold Condensed font is under license from the Monotype Corporation. Windows is a registered trademark of Microsoft Corporation.

All other trademarks are the property of their respective owners. Information in this document is subject to change without notice and does not represent a commitment on the part of TSC Auto ID Technology Co. No part of this manual may be reproduced or transmitted in any form or by any means, for any purpose other than the purchaser's personal use, without the expressed written permission of TSC Auto ID Technology Co.

# TABLE OF CONTENT

<b>1. FUNDAMENTAL OF THE SYSTEM .....</b>	<b>3</b>
1.1. Overview.....	3
<b>2. ELECTRONICS.....</b>	<b>7</b>
2.1 Summary of Board Connectors .....	7
2.2 Pin Configuration.....	12
<b>3. MECHANISM .....</b>	<b>14</b>
3.1 Remove Covers.....	14
3.2 Replacing the LCD Panel Module.....	16
3.3 Replacing the Power Supply Unit.....	18
3.4 Replacing Multi-interface Board.....	19
3.5 Replacing the Main Board.....	20
3.6 Replacing the Platen Roller Assembly.....	21
3.7 Replacing the Stepping Motor .....	22
3.8 Replacing the Printhead ASS'Y .....	23
3.9 Replacing the Gap and Black-mark Sensor Module .....	25
3.10 Replacing the DC Motor .....	26
3.11 Installing the Cutter Module.....	27
3.12 Replacing the Cutter Driver IC Board.....	29
<b>4. TROUBLESHOOTING .....</b>	<b>31</b>
4.1 Common Problems .....	31
<b>5. MAINTENANCE .....</b>	<b>35</b>
<b>UPDATE HISTORY .....</b>	<b>37</b>

# 1. FUNDAMENTAL OF THE SYSTEM

## 1.1. Overview

### Front View



1. LED indicators
2. Touch screen
3. Operation buttons
4. Media viewer
5. Paper exit chute
6. Printer right side cover opener

## Interior View

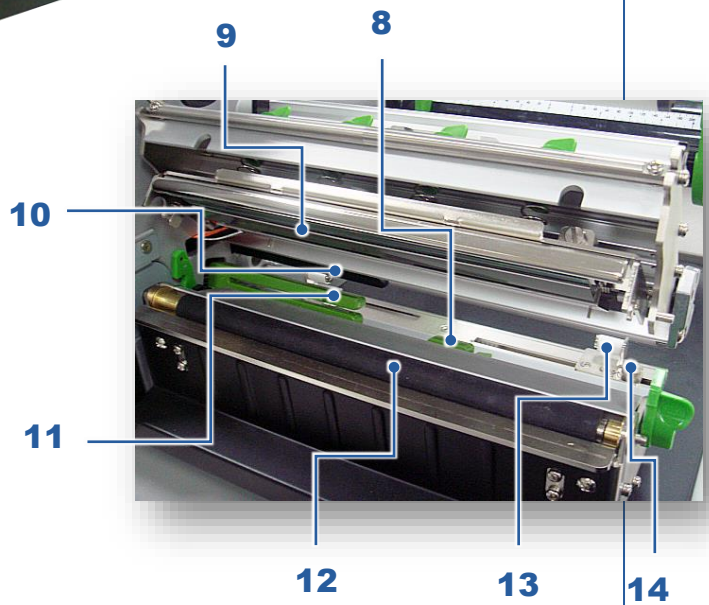
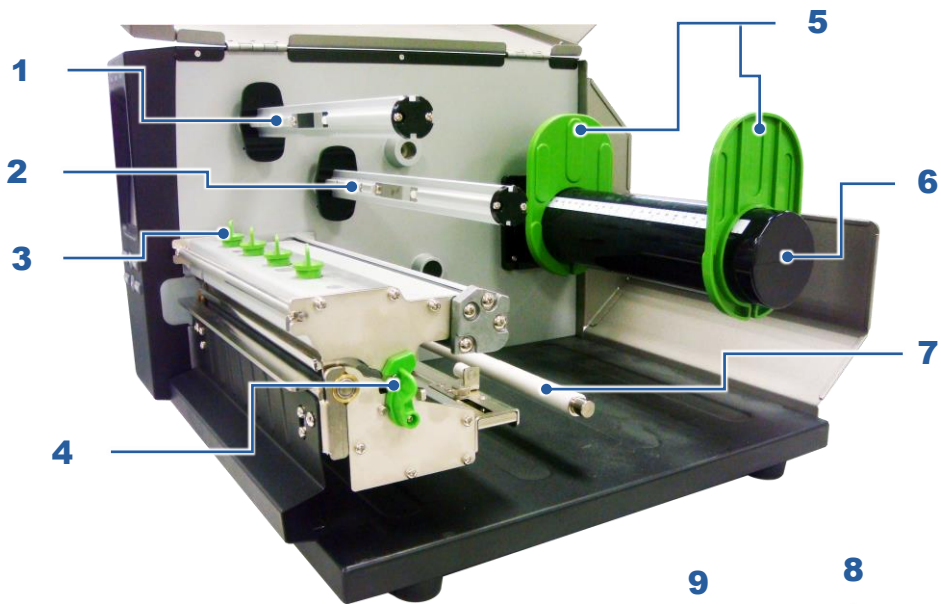

1. Ribbon rewind spindle
2. Ribbon supply spindle
3. Print head pressure adjustment knobs
4. Print head release lever
5. Label roll guards
6. Label supply spindle
7. Media guide bar
8. Black mark sensor
9. Print head
10. Ribbon sensor
11. Gap sensor
12. Platen roller
13. Label guide
14. Fixed screw

## Rear View

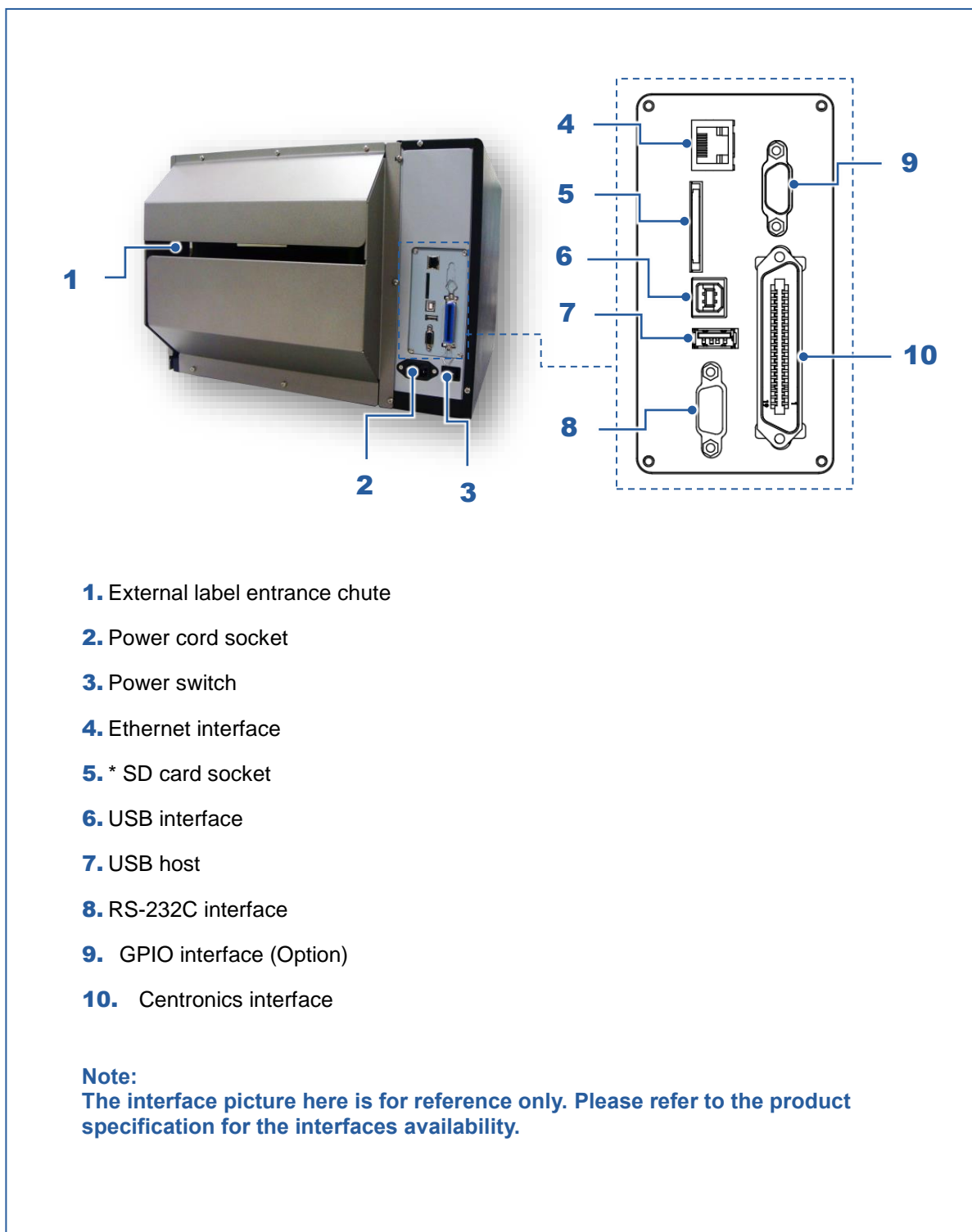

\* Recommended SD card specification

Type	SD card spec	SD card capacity	Approved SD card manufacturer
SDHC	V2.0 Class 4	2G	Transcend
	V3.0 Class 10	32G	Kingston
	V3.0 Class 10	16G	Kingston
	V2.0 Class 4	8G	Scandisk
	V3.0 Class 10	32G	Scandisk
Micro SD	V2.0 Class 4	4G	Transcend
	V2.0 Class 4	8G	Transcend
	V3.0 Class 10 UHS-I	16G	Transcend
	V3.0 Class 10 UHS-I	32G	Transcend
	V3.0 Class 10	16G	Kingston
	V2.0 Class 4	16G	Scandisk
	V3.0 Class 10 UHS-I	16G	Scandisk
<ul style="list-style-type: none"> <li>- The DOS FAT file system is supported for the SD card.</li> <li>- Folders/files stored in the SD card should be in the 8.3 filename format.</li> <li>- The miniSD/microSD card to SD card slot adapter is required.</li> </ul>			

## 2. ELECTRONICS

### 2.1 Summary of Board Connectors

#### Main board

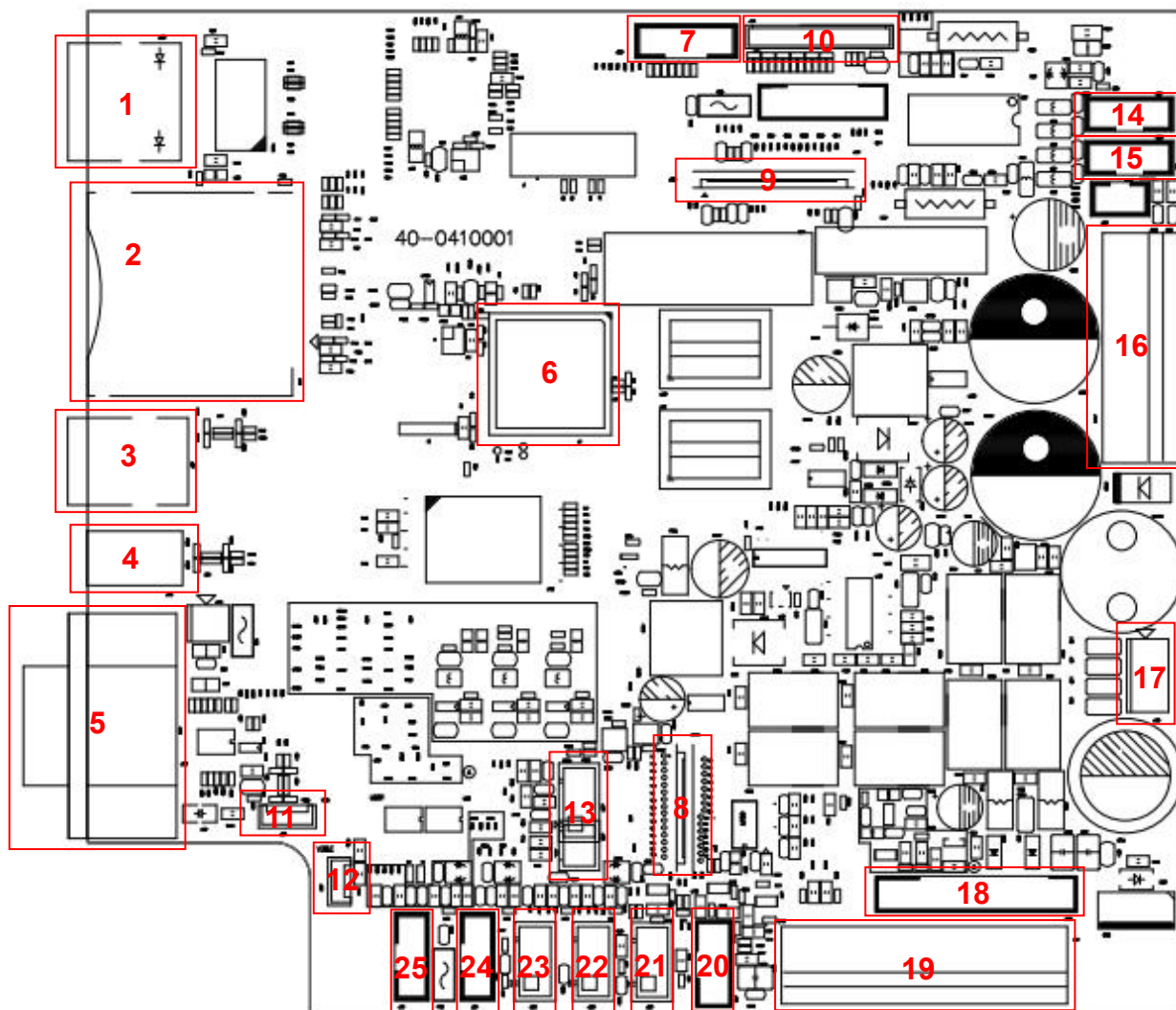

Connector	Description
1	Ethernet RJ-45 connector
2	SD card slot
3	USB device connector
4	USB host connector
5	RS-232C connector
6	Microprocessor
7	GPIO connector
8	Centronics port FPC connector

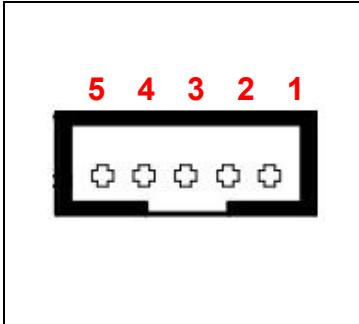
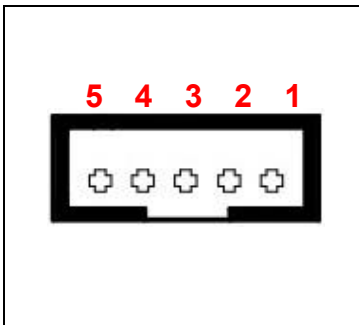

<b>9</b>	TFT LCD panel FPC connector																		
<b>10</b>	KEY & LED connector																		
<b>11</b>	USB host internal connector (Reserve)																		
<b>12</b>	I2C internal connector (Reserve)																		
<b>13</b>	RFID module connector (4" 6pin / 6" or 8" 4pin)																		
<b>14</b>	Ribbon recover sensor connector (For 6" 8" used only) (Blue)																		
	 <table border="1"> <thead> <tr> <th>Pin</th> <th>Description</th> <th>Voltage</th> </tr> </thead> <tbody> <tr> <td>1</td> <td>Ribbon encoder sensor emitter power pin</td> <td>4.0~4.15V</td> </tr> <tr> <td>2</td> <td>Ribbon encoder sensor receiver</td> <td>A/D: 0~3.3V</td> </tr> <tr> <td>3</td> <td>GND</td> <td>0V</td> </tr> <tr> <td>4</td> <td>DC motor signal pin</td> <td></td> </tr> <tr> <td>5</td> <td>DC motor signal pin</td> <td></td> </tr> </tbody> </table>	Pin	Description	Voltage	1	Ribbon encoder sensor emitter power pin	4.0~4.15V	2	Ribbon encoder sensor receiver	A/D: 0~3.3V	3	GND	0V	4	DC motor signal pin		5	DC motor signal pin	
	Pin	Description	Voltage																
	1	Ribbon encoder sensor emitter power pin	4.0~4.15V																
	2	Ribbon encoder sensor receiver	A/D: 0~3.3V																
	3	GND	0V																
4	DC motor signal pin																		
5	DC motor signal pin																		
<b>15</b>	Ribbon supply sensor connector (For 6" 8" used only) (Red)																		
	 <table border="1"> <thead> <tr> <th>Pin</th> <th>Description</th> <th>Voltage</th> </tr> </thead> <tbody> <tr> <td>1</td> <td>Ribbon encoder sensor emitter power pin</td> <td>4.0~4.15V</td> </tr> <tr> <td>2</td> <td>Ribbon encoder sensor receiver</td> <td>A/D: 0~3.3V</td> </tr> <tr> <td>3</td> <td>GND</td> <td>0V</td> </tr> <tr> <td>4</td> <td>DC motor signal pin</td> <td></td> </tr> <tr> <td>5</td> <td>DC motor signal pin</td> <td></td> </tr> </tbody> </table>	Pin	Description	Voltage	1	Ribbon encoder sensor emitter power pin	4.0~4.15V	2	Ribbon encoder sensor receiver	A/D: 0~3.3V	3	GND	0V	4	DC motor signal pin		5	DC motor signal pin	
	Pin	Description	Voltage																
	1	Ribbon encoder sensor emitter power pin	4.0~4.15V																
	2	Ribbon encoder sensor receiver	A/D: 0~3.3V																
	3	GND	0V																
4	DC motor signal pin																		
5	DC motor signal pin																		
<b>16</b>	Power supply output (24V DC) connector																		
<b>17</b>	Stepping motor connector																		
<b>18</b>	Print head data connector																		
<b>19</b>	Print head power connector																		
<b>20</b>	Cutter/peel-off sensor connector																		

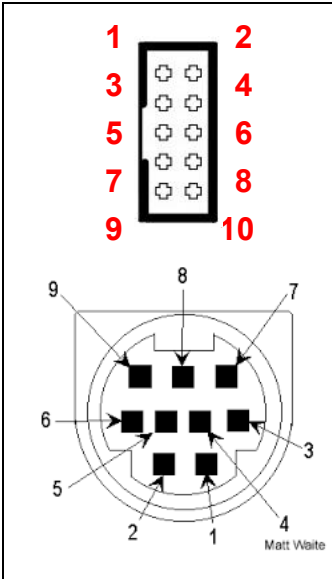
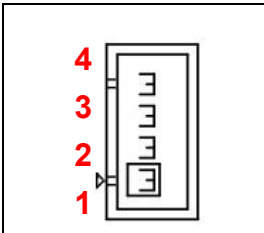
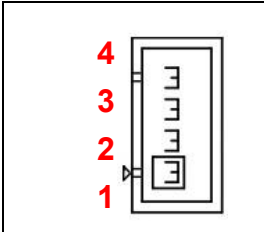
		<table border="1"> <thead> <tr> <th>Pin</th> <th>Description</th> <th>Voltage</th> </tr> </thead> <tbody> <tr> <td>1</td> <td>Cutter enable</td> <td>0V: Cutter work 5V: Cutter stop</td> </tr> <tr> <td>2</td> <td>Cutter direction</td> <td>0V: Cutter positive cut 5V: Cutter negative cut</td> </tr> <tr> <td>3</td> <td>Cutter position sensor switch</td> <td>0V: Cutter stop 3.3V: Cutter work</td> </tr> <tr> <td>4</td> <td>Peel sensor receiver</td> <td>A/D: 0~3.3V</td> </tr> <tr> <td>5</td> <td>N/A</td> <td>N/A</td> </tr> <tr> <td>6</td> <td>Logic power</td> <td>5V</td> </tr> <tr> <td>7</td> <td>GND</td> <td>0V</td> </tr> <tr> <td>8</td> <td>Cutter power</td> <td>24V</td> </tr> <tr> <td>9</td> <td>I2C SCL signal</td> <td></td> </tr> <tr> <td>10</td> <td>I2C SDA signal</td> <td></td> </tr> </tbody> </table>	Pin	Description	Voltage	1	Cutter enable	0V: Cutter work 5V: Cutter stop	2	Cutter direction	0V: Cutter positive cut 5V: Cutter negative cut	3	Cutter position sensor switch	0V: Cutter stop 3.3V: Cutter work	4	Peel sensor receiver	A/D: 0~3.3V	5	N/A	N/A	6	Logic power	5V	7	GND	0V	8	Cutter power	24V	9	I2C SCL signal		10	I2C SDA signal		
Pin	Description	Voltage																																		
1	Cutter enable	0V: Cutter work 5V: Cutter stop																																		
2	Cutter direction	0V: Cutter positive cut 5V: Cutter negative cut																																		
3	Cutter position sensor switch	0V: Cutter stop 3.3V: Cutter work																																		
4	Peel sensor receiver	A/D: 0~3.3V																																		
5	N/A	N/A																																		
6	Logic power	5V																																		
7	GND	0V																																		
8	Cutter power	24V																																		
9	I2C SCL signal																																			
10	I2C SDA signal																																			
<p><b>Note:</b> 9 Pin Mini Din for cutter/peel-off module connector</p>																																				
21	<p>Head open sensor connector</p> 	<table border="1"> <thead> <tr> <th>Pin</th> <th>Description</th> <th>Voltage</th> </tr> </thead> <tbody> <tr> <td>1</td> <td>Head open sensor emitter power pin</td> <td>1.2~1.4V</td> </tr> <tr> <td>2</td> <td>GND</td> <td>0V</td> </tr> <tr> <td>3</td> <td>Logic power</td> <td>3.3V</td> </tr> <tr> <td>4</td> <td>Head open sensor receiver</td> <td>0V: Head close 3.3V: Head open</td> </tr> </tbody> </table>	Pin	Description	Voltage	1	Head open sensor emitter power pin	1.2~1.4V	2	GND	0V	3	Logic power	3.3V	4	Head open sensor receiver	0V: Head close 3.3V: Head open																			
Pin	Description	Voltage																																		
1	Head open sensor emitter power pin	1.2~1.4V																																		
2	GND	0V																																		
3	Logic power	3.3V																																		
4	Head open sensor receiver	0V: Head close 3.3V: Head open																																		
22	<p>Ribbon sensor connector</p> 	<table border="1"> <thead> <tr> <th>Pin</th> <th>Description</th> <th>Voltage</th> </tr> </thead> <tbody> <tr> <td>1</td> <td>Ribbon sensor receiver</td> <td>A/D: 0~3.3V</td> </tr> <tr> <td>2</td> <td>Ribbon sensor emitter power pin</td> <td>5V</td> </tr> <tr> <td>3</td> <td>GND</td> <td>0V</td> </tr> <tr> <td>4</td> <td>Ribbon sensor emitter</td> <td>4.0~4.1V: Emitter on 4.3~4.4V: Emitter off</td> </tr> </tbody> </table>	Pin	Description	Voltage	1	Ribbon sensor receiver	A/D: 0~3.3V	2	Ribbon sensor emitter power pin	5V	3	GND	0V	4	Ribbon sensor emitter	4.0~4.1V: Emitter on 4.3~4.4V: Emitter off																			
Pin	Description	Voltage																																		
1	Ribbon sensor receiver	A/D: 0~3.3V																																		
2	Ribbon sensor emitter power pin	5V																																		
3	GND	0V																																		
4	Ribbon sensor emitter	4.0~4.1V: Emitter on 4.3~4.4V: Emitter off																																		
23	<p>Black mark sensor connector (For 6" 8" used only)</p>																																			

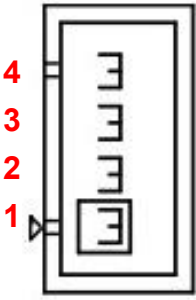
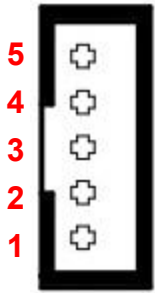
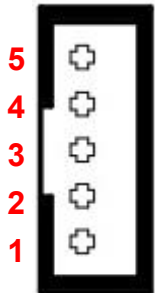
		<table border="1"> <thead> <tr> <th>Pin</th> <th>Description</th> <th>Voltage</th> </tr> </thead> <tbody> <tr> <td>1</td> <td>Black mark sensor receiver</td> <td>A/D: 0~3.3V</td> </tr> <tr> <td>2</td> <td>Black mark sensor emitter power pin</td> <td>5V</td> </tr> <tr> <td>3</td> <td>GND</td> <td>0V</td> </tr> <tr> <td>4</td> <td>Black mark sensor emitter</td> <td>4.0~4.1V: Emitter on 4.3~4.4V: Emitter off</td> </tr> </tbody> </table>	Pin	Description	Voltage	1	Black mark sensor receiver	A/D: 0~3.3V	2	Black mark sensor emitter power pin	5V	3	GND	0V	4	Black mark sensor emitter	4.0~4.1V: Emitter on 4.3~4.4V: Emitter off				
Pin	Description	Voltage																			
1	Black mark sensor receiver	A/D: 0~3.3V																			
2	Black mark sensor emitter power pin	5V																			
3	GND	0V																			
4	Black mark sensor emitter	4.0~4.1V: Emitter on 4.3~4.4V: Emitter off																			
24	Gap sensor connector 	<table border="1"> <thead> <tr> <th>Pin</th> <th>Description</th> <th>Voltage</th> </tr> </thead> <tbody> <tr> <td>1</td> <td>Power</td> <td>5V</td> </tr> <tr> <td>2</td> <td>Gap sensor emitter</td> <td>4.0~4.1V: Emitter on 4.3~4.4V: Emitter off</td> </tr> <tr> <td>3</td> <td>Black mark sensor emitter</td> <td>4.0~4.1V: Emitter on 4.3~4.4V: Emitter off</td> </tr> <tr> <td>4</td> <td>Gap and black mark sensor receiver</td> <td>A/D: 0~3.3V</td> </tr> <tr> <td>5</td> <td>GND</td> <td>0V</td> </tr> </tbody> </table>	Pin	Description	Voltage	1	Power	5V	2	Gap sensor emitter	4.0~4.1V: Emitter on 4.3~4.4V: Emitter off	3	Black mark sensor emitter	4.0~4.1V: Emitter on 4.3~4.4V: Emitter off	4	Gap and black mark sensor receiver	A/D: 0~3.3V	5	GND	0V	
Pin	Description	Voltage																			
1	Power	5V																			
2	Gap sensor emitter	4.0~4.1V: Emitter on 4.3~4.4V: Emitter off																			
3	Black mark sensor emitter	4.0~4.1V: Emitter on 4.3~4.4V: Emitter off																			
4	Gap and black mark sensor receiver	A/D: 0~3.3V																			
5	GND	0V																			
25	Rewind connector 	<table border="1"> <thead> <tr> <th>Pin</th> <th>Description</th> <th>Voltage</th> </tr> </thead> <tbody> <tr> <td>1</td> <td>Power</td> <td>24V</td> </tr> <tr> <td>2</td> <td>Cutter direction signal</td> <td></td> </tr> <tr> <td>3</td> <td>Cutter enable signal</td> <td></td> </tr> <tr> <td>4</td> <td>Cutter position sensor switch signal</td> <td></td> </tr> <tr> <td>5</td> <td>GND</td> <td>0V</td> </tr> </tbody> </table>	Pin	Description	Voltage	1	Power	24V	2	Cutter direction signal		3	Cutter enable signal		4	Cutter position sensor switch signal		5	GND	0V	
Pin	Description	Voltage																			
1	Power	24V																			
2	Cutter direction signal																				
3	Cutter enable signal																				
4	Cutter position sensor switch signal																				
5	GND	0V																			

## GPIO with multi-interface board

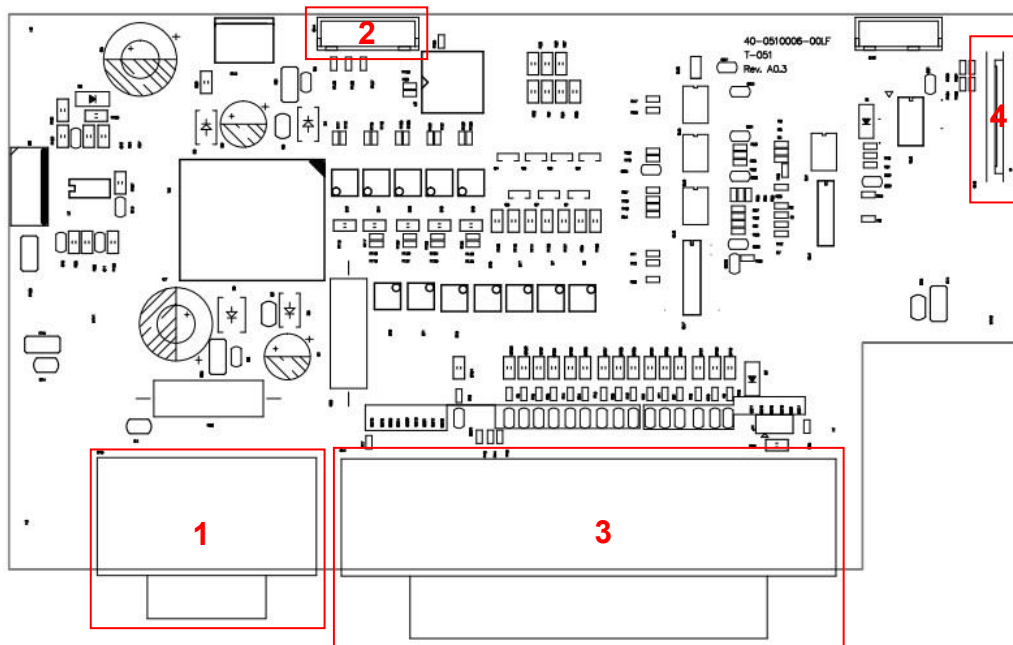

Connector	Description	Remark
1	GPIO connector	
2	GPIO power and control signal connector	
3	Centronics port connector	
4	Centronics port FPC connector	

## 2.2 Pin Configuration

### RS-232C

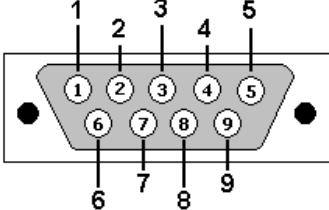
	PIN	CONFIGURATION
	1	+5 V
	2	TXD
	3	RXD
	4	CTS
	5	GND
	6	RTS
	7	N/C
	8	RTS
	9	N/C

### USB

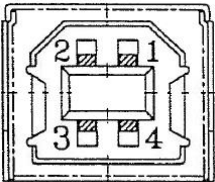
	PIN	CONFIGURATION
	1	N/C
	2	D-
	3	D+
	4	GND

### Centronics

Pin	SPP Mode	Nibble	In/Out	Function
1	Strobe	N/A	In	A <b>low</b> on this line indicates that there are valid data at the host. When this pin is de-asserted, the +ve clock edge should be used to shift the data into the device.
2-9	Data 0-7	N/A	In	Data Bus. Single-directional.
10	Ack	N/A	Out	A <b>low</b> on this line indicates that there are valid data at the Device. When this pin is de-asserted, the +ve clock edge should be used to shift the data into the host.
11	Busy	N/A	Out	When in reverse direction, a <b>high</b> indicates data, while a <b>low</b> indicates a command cycle. In forward direction, it functions as PtrBusy.
12	Paper Out /	N/A	Out	When <b>low</b> , device acknowledges reverse request.

	End			
13	Select	N/A	Out	Extensibility flag
14	Ground	N/A	GND	
15	No Defined	N/A	N/A	
16-17	Ground	N/A	GND	Ground
18	No Defined	N/A	N/A	
19-30	Ground	N/A	GND	Ground
31	No Defined	N/A	N/A	
32	Error / Fault	N/A	Out	A <b>low</b> set by the device indicates that the reverse data is available
33-35	Ground	N/A	GND	Ground
36	No Defined	N/A	N/A	

### Ethernet

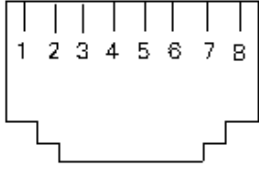
	PIN	CONFIGURATION
	1	Tx+
	2	Tx-
	3	Rx+
	4	N/C
	5	N/C
	6	Rx-
	7	N/C
	8	N/C

### GPIO(HD15F)

		GP-IO
GND-IO	1	
5V-IO	2	
GPI-1	3	
GPI-2	4	
GPI-3	5	
GPI-4	6	
24V-IN	7	
GND-IO	8	
GPO-1	9	
GPO-2	10	
GPO-3	11	
GPO-4	12	
GPO-5	13	
GPO-6	14	
GPO-7	15	

### 3. MECHANISM

#### 3.1 Remove Covers

1. Remove 4 screws from printer.



2. Open printer right side cover and remove 2 screws then close the cover.

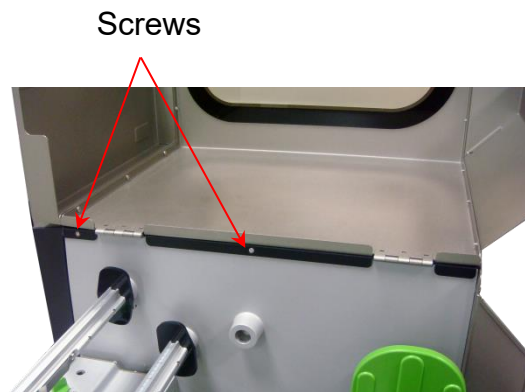

3. Remove the electronics cover.

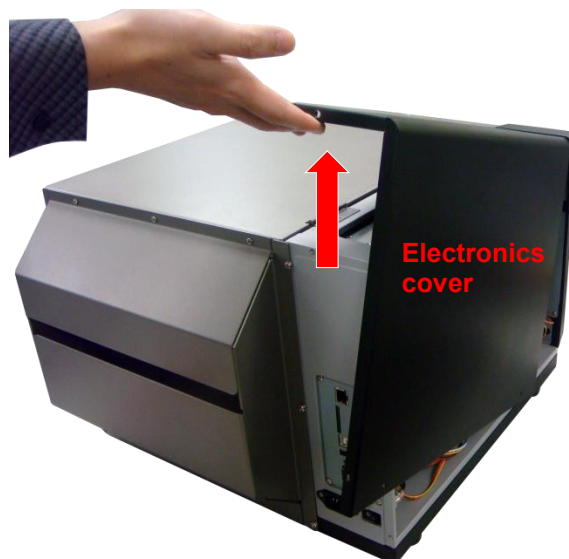

4. Remove 3 screws from each hinge. Be careful the right side cover may fall out from the printer. Take out the right side cover from the printer.

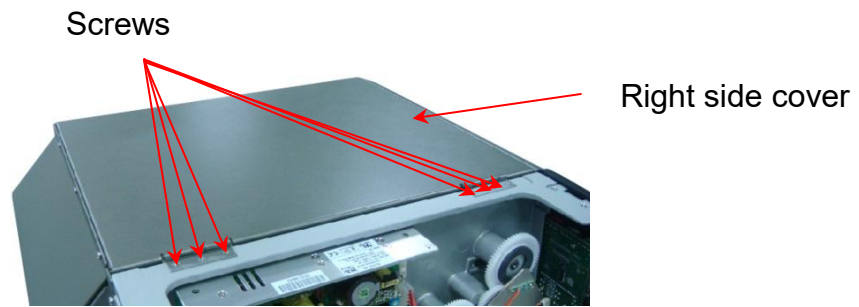

5. Reassemble the parts in the reverse procedures.



## 3.2 Replacing the LCD Panel Module

1. Refer to section 3.1 to remove the electronics cover.
2. Remove 2 screws on the module bracket.



3. Push the tab to remove the LCD panel module.

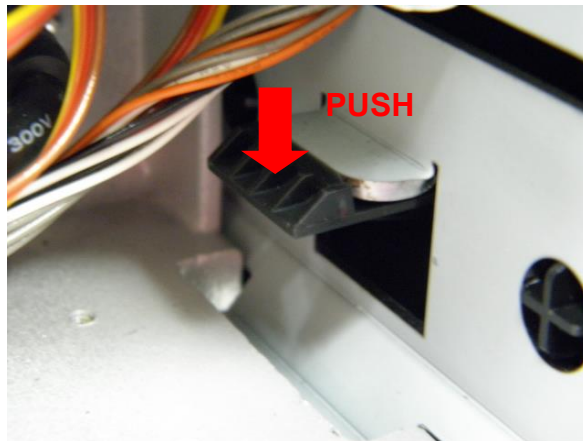

4. Remove 4 screws to remove the module bracket.



5. Disconnect 3 harnesses to replace the LCD panel module.

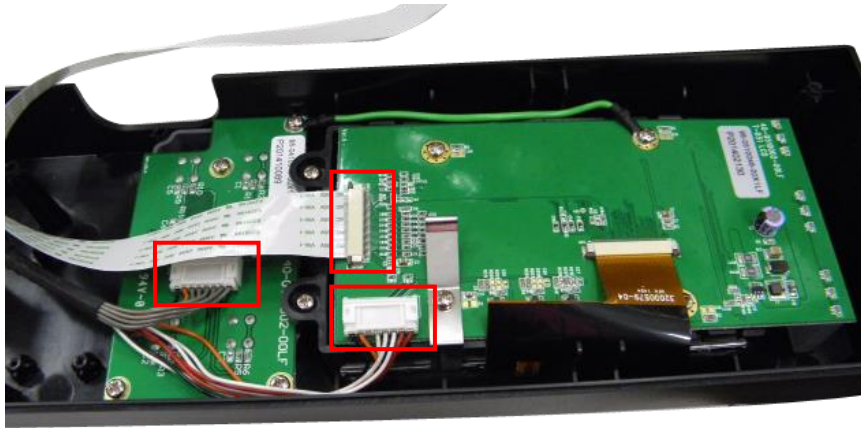

6. Reassemble the parts in the reverse procedures.

### 3.3 Replacing the Power Supply Unit

1. Refer to section 3.1 to remove the electronics cover.
2. Disconnect 2 connectors and remove 2 screws on the power supply unit.



3. Replace the power supply unit.
- 4 . Reassemble the parts in the reverse procedures.

### 3.4 Replacing Multi-interface Board

1. Refer to section 3.1 to remove the electronics cover.
2. Remove 2 screws from multi-interface board. Disconnect 2 connectors.

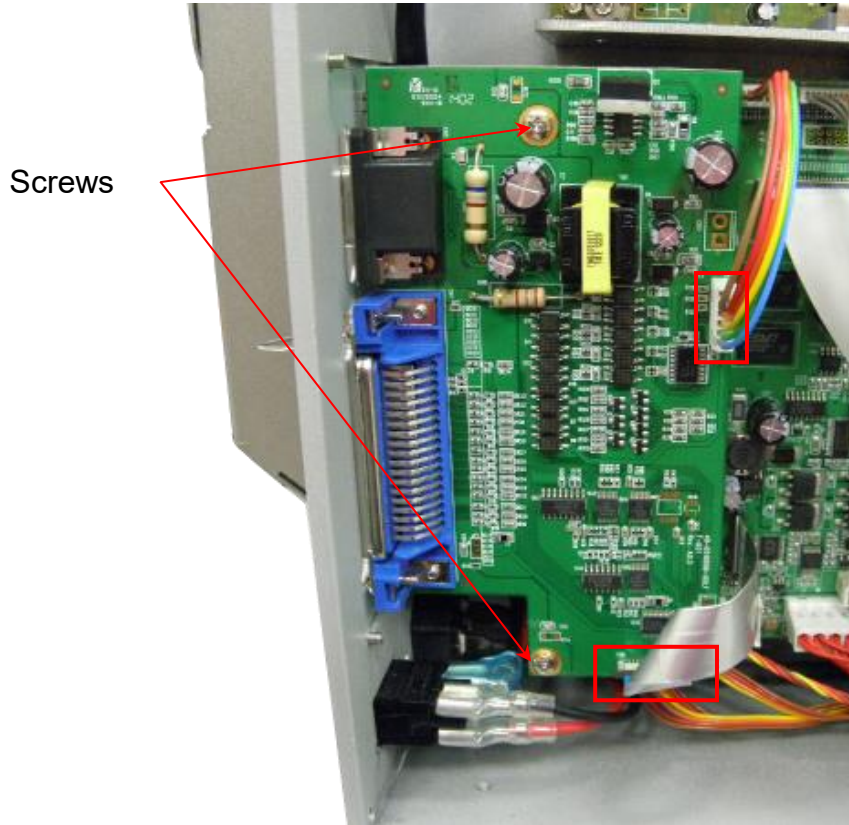

3. Replace the multi-interface board.
4. Reassemble the parts in the reverse procedures.

### 3.5 Replacing the Main Board

1. Refer to section 3.1 and 3.4 to remove electronics cover and multi-interface board.
2. Remove 4 screws to take off the interface plate.

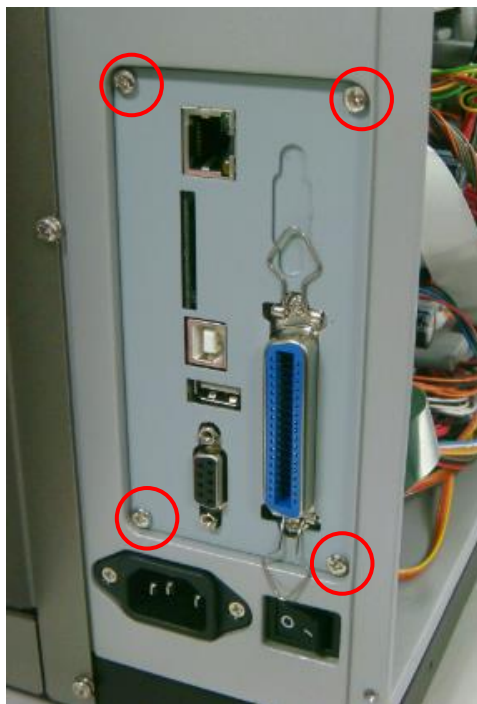

2. Disconnect all connectors from the main board. Remove 2 copper pillars and 2 screws.

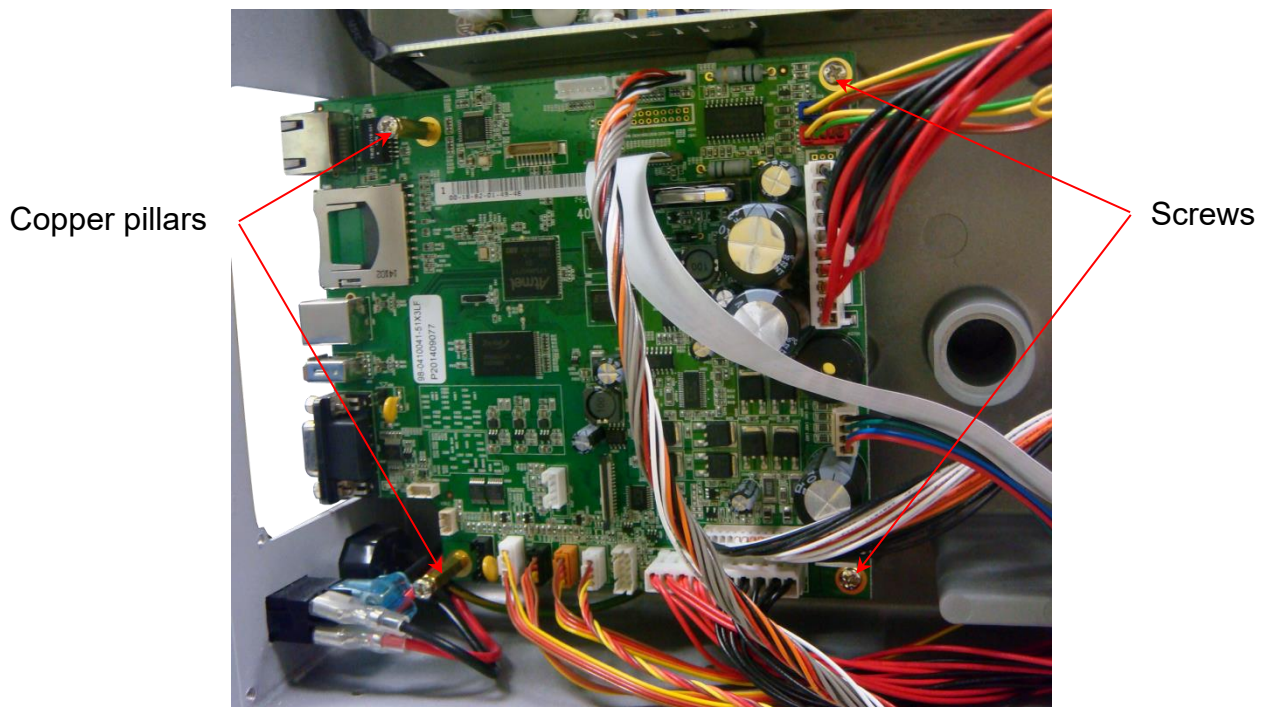

4. Replace the main board.
5. Reassemble the parts in the reverse procedures.



### 3.6 Replacing the Platen Roller Assembly

1. Open printer right side cover.
2. Disengage print head lift lever.
3. Remove the cutter module or lower front panel.
4. Remove 4 screws from the platen holder.

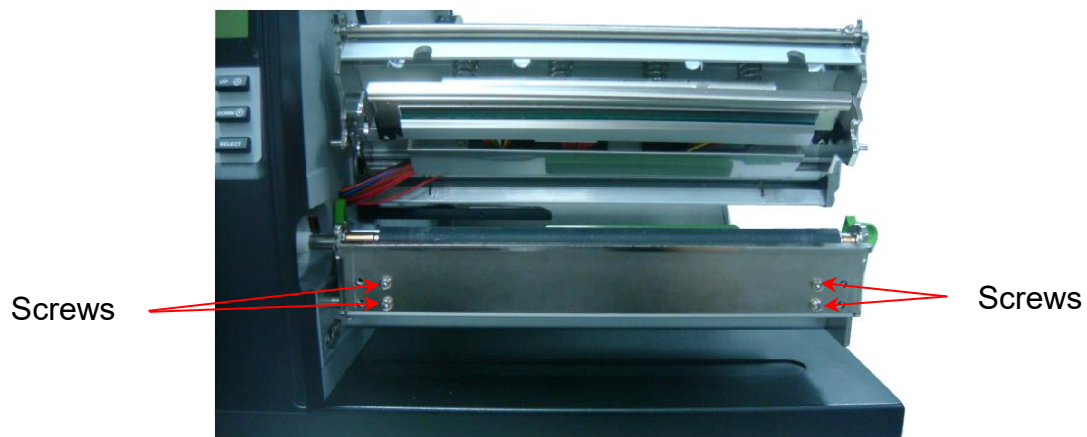

5. Take out the platen holder, platen roller assembly and replace a new platen roller assembly.

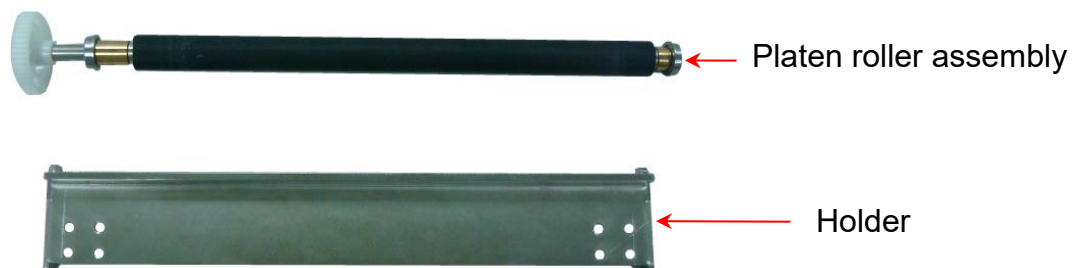

6. Reassemble the parts in the reverse procedures.

## 3.7 Replacing the Stepping Motor

1. Refer to section 3.1 to remove the electronics cover.
2. Disconnect the stepping motor connector. Remove 2 screws on the stepping motor.

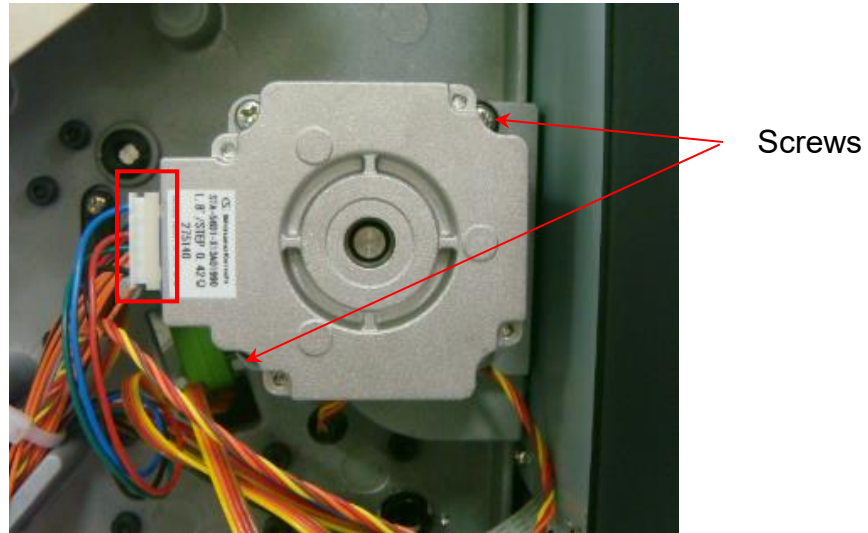

3. Replace the stepping motor.
4. Reassemble the parts in the reverse procedures.

### 3.8 Replacing the Printhead ASS'Y

1. Open the printer right side cover.
2. Disengage printhead release lever.
3. Remove 2 screws from the mechanism.

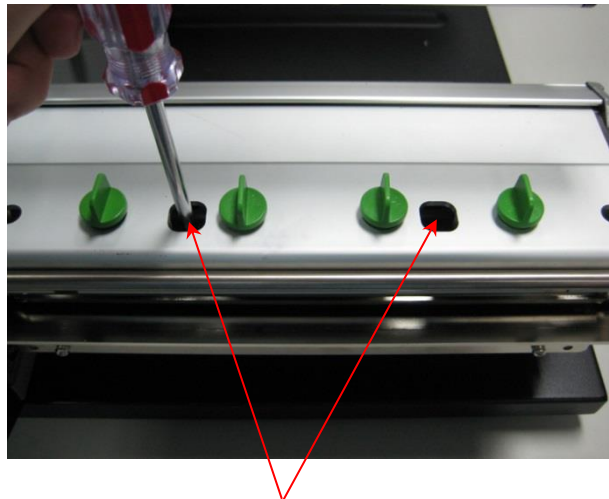

Screws

4. Carefully disconnect 3 connectors from the printhead ASS'Y.

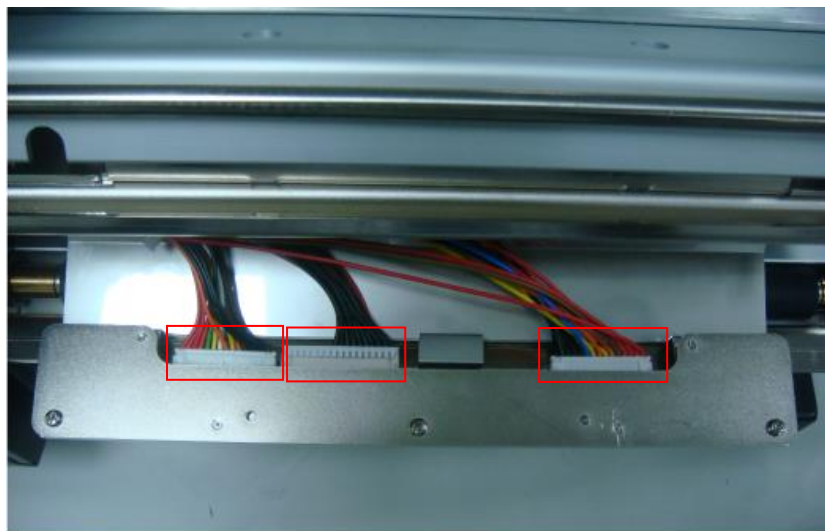

5. Replace the printhead ASS'Y.





6. Connect the printhead cable and carefully slide assembly into the print mechanism. The holes of printhead assembly must align and then insert the tenons of print mechanism.

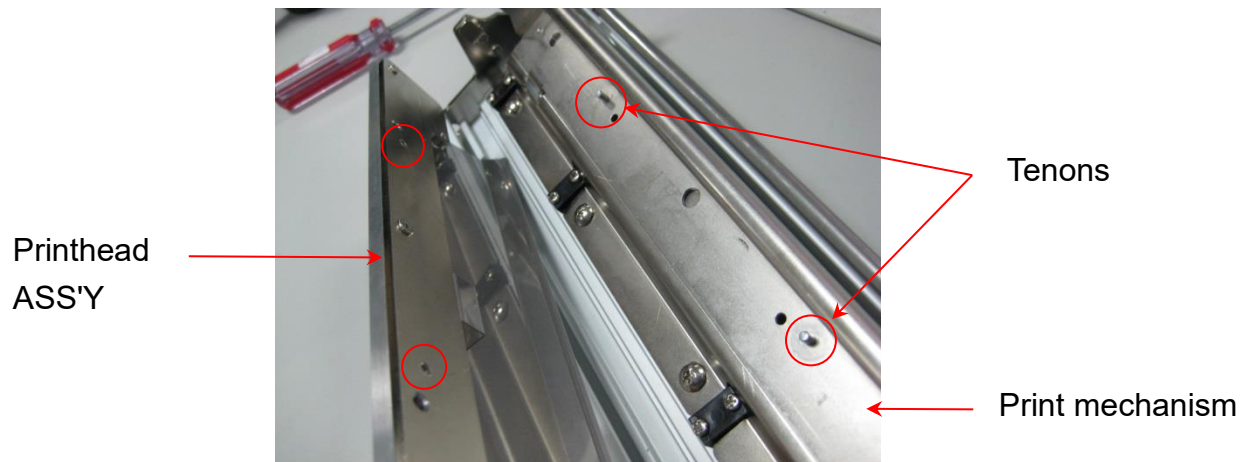

7. Reassemble the parts in the reverse procedures.

### 3.9 Replacing the Gap and Black-mark Sensor Module

1. Open the printer right side cover.
2. Disengage printhead release lever.
3. Refer to section 3.1 and 3.4 to remove electronics cover and multi-interface board.
4. Disconnect the gap and black-mark sensor connectors from the main board.

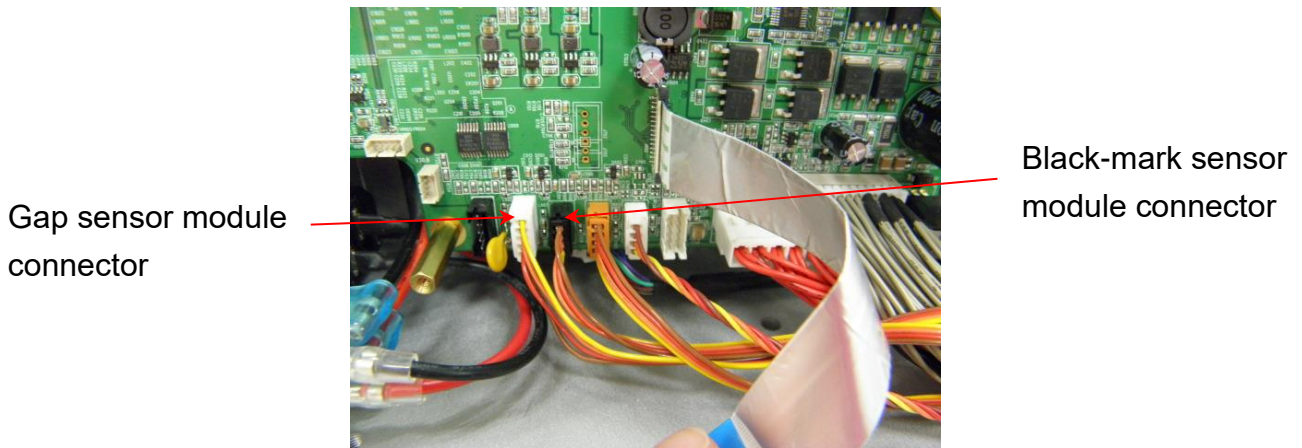

5. Remove 5 screws to take off the lower printhead mechanism.

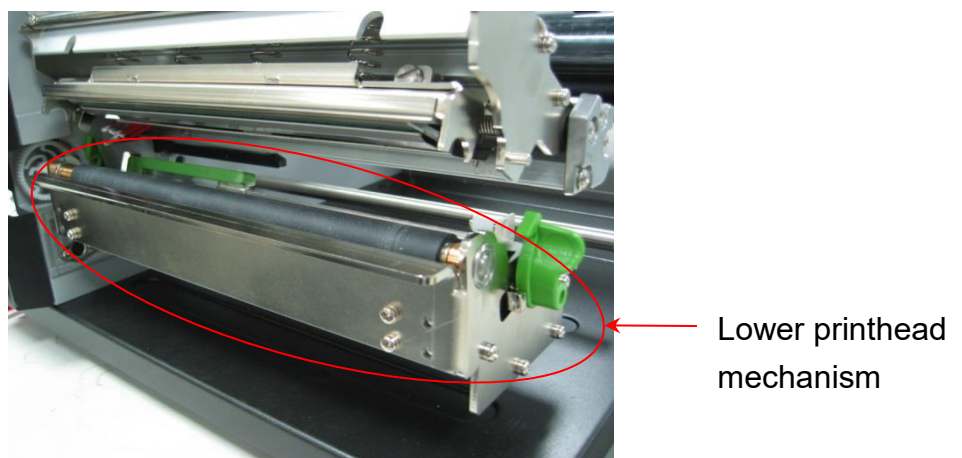
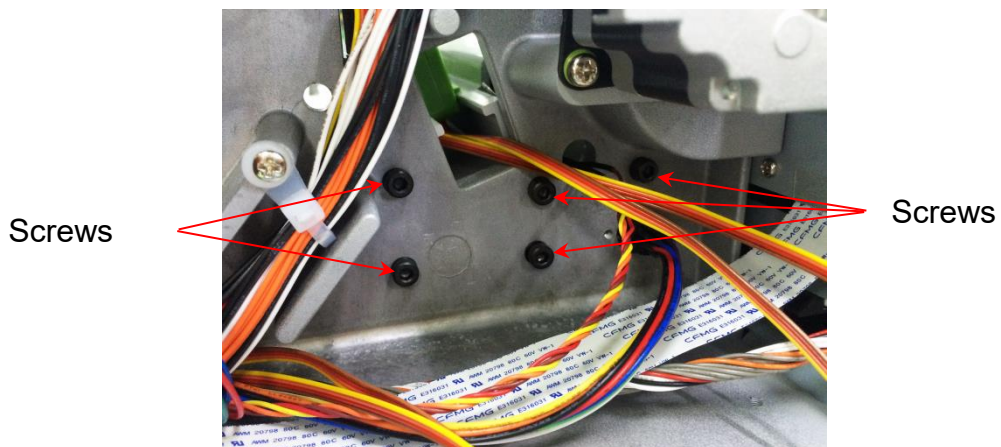

6. Replace the sensor module.
7. Reassemble the parts in the reverse procedures.

### 3.10 Replacing the DC Motor

1. Refer to section 3.1 to remove the electronics cover.
2. Disconnect the DC motor connectors from the main board.

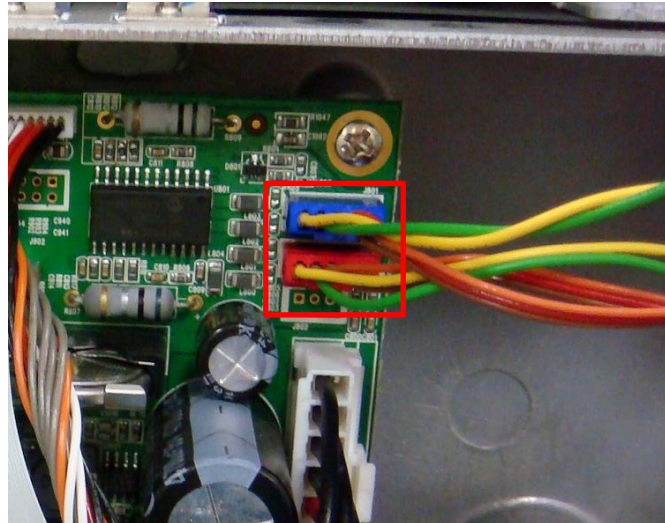

3. Remove 7 screws at the DC motor fixing plate and sensor modules.

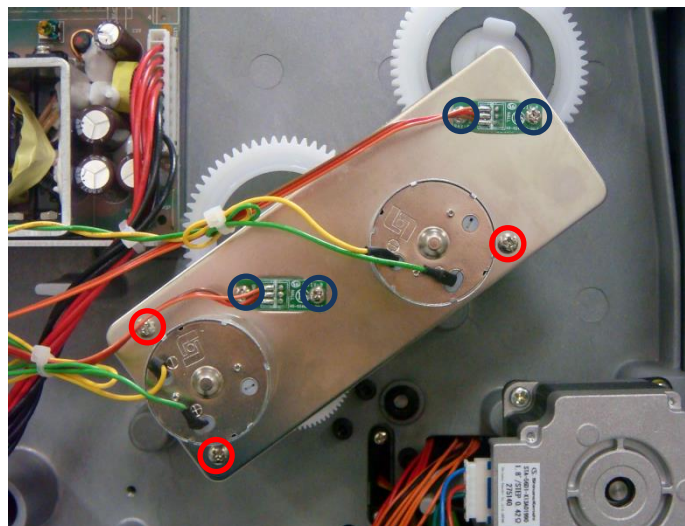

4. Remove the DC motors by removing the 6 screws.

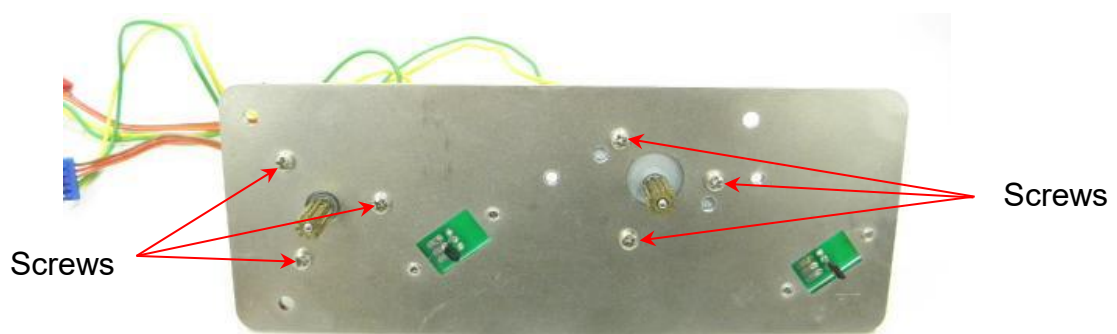

5. Replace the DC motors.
6. Reassemble the parts in the reverse procedures.



### 3.11 Installing the Cutter Module

1. Please turn off the power switch of printer before installing parts.
2. Open the printer right side cover.
3. Remove 2 screws to remove lower front panel.

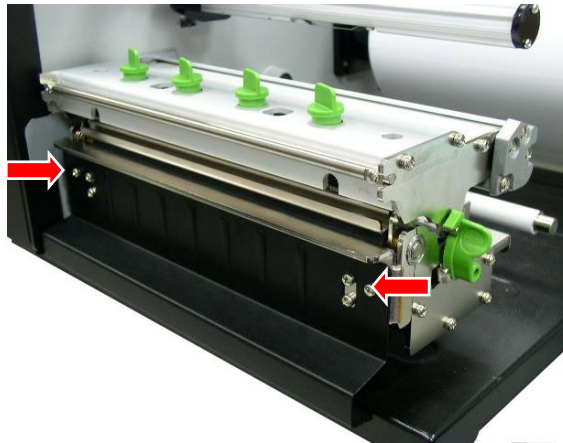

4. Plug the cutter mini DIN cable connector into the cutter connector. The arrow mark on the connector must be at the upper side.

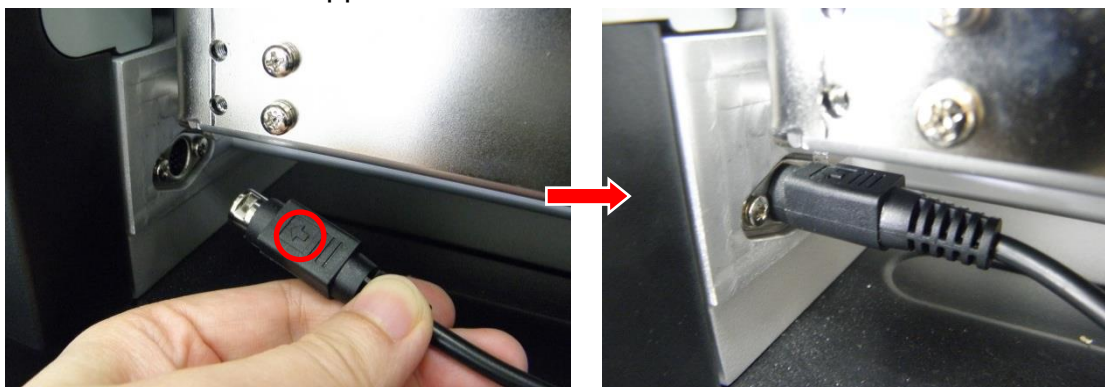

5. Attach the cutter module to the front of the platen roller. Align the cutter bracket screw holes to the screw holes that fix the lower front panel. Make sure the two locating protrusions on the cutter module snap into the locating holes on the platen holder plate.

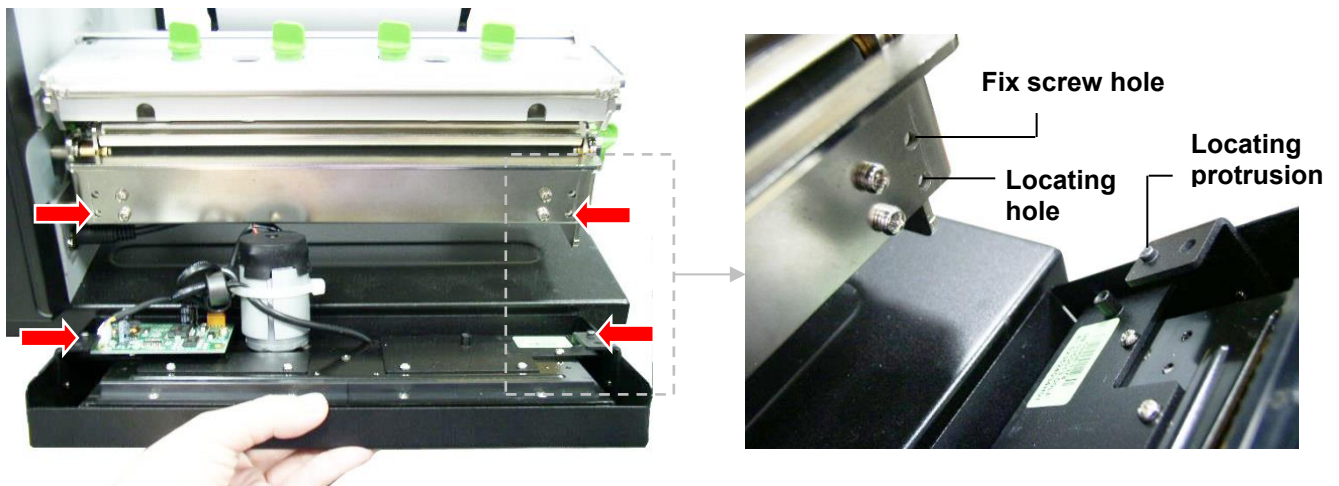

6. Fasten the 2 screws at the cutter bracket to fix the cutter module to the printer mechanism.



**Note:**

**Except for the linerless cutter, all regular/ heavy duty/ care label cutters DO NOT cut on media with glue.  
For more details, please refer to the cutter specification in the user's manual.**

### 3.12 Replacing the Cutter Driver IC Board

1. Remove 2 connectors on the cutter driver IC board.

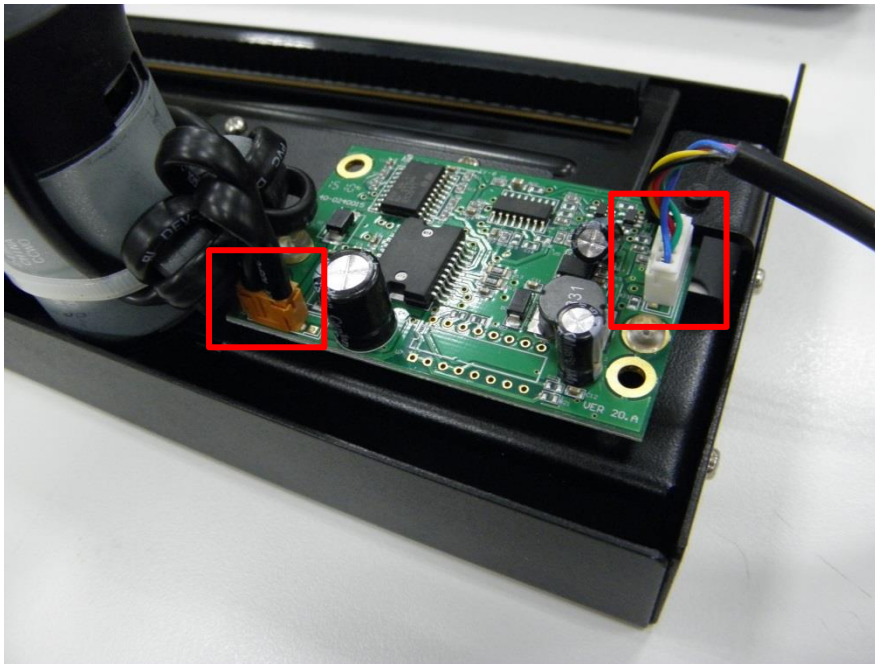

2. Remove 2 screws to remove/replace the cutter driver IC board.

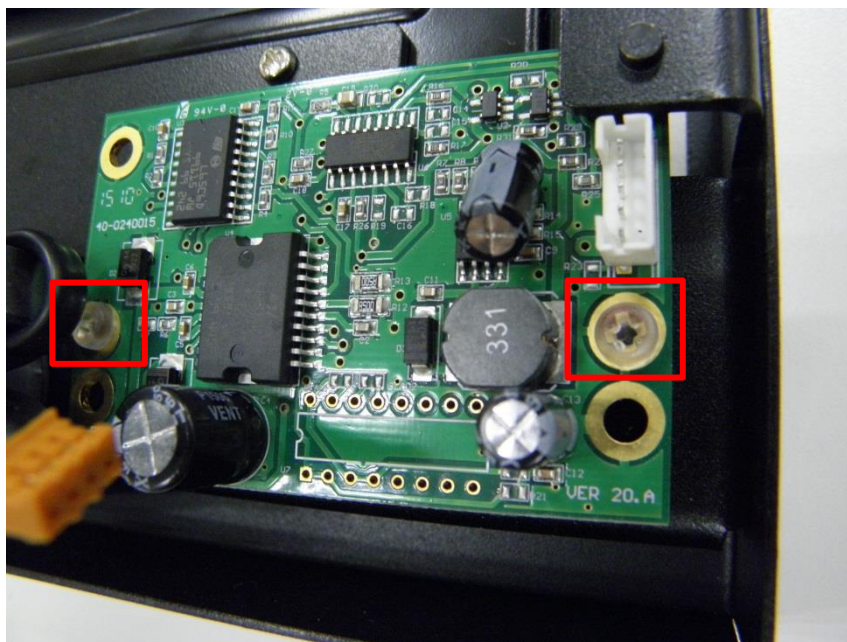

3. Reassemble the parts in the reverse procedures.



## 4. TROUBLESHOOTING

### 4.1 Common Problems

The following guide lists the most common problems that might be encountered when operating this bar code printer. If the printer still does not function after all suggested solutions have been invoked, please contact the Customer Service Department of your purchased reseller or distributor for assistance.

Problem	Possible Cause	Recovery Procedure
<b>Power indicator does not illuminate</b>	<ul style="list-style-type: none"> <li>* The power cord is not properly connected.</li> </ul>	<ul style="list-style-type: none"> <li>* Plug the power cord in printer and outlet.</li> <li>* Switch the printer on.</li> </ul>
<b>Carriage Open</b>	<ul style="list-style-type: none"> <li>* The printer carriage is open.</li> </ul>	<ul style="list-style-type: none"> <li>* Please close the print carriage.</li> </ul>
<b>No Ribbon</b>	<ul style="list-style-type: none"> <li>* Running out of ribbon.</li> <li>* The ribbon is installed incorrectly.</li> </ul>	<ul style="list-style-type: none"> <li>* Supply a new ribbon roll.</li> <li>* Please refer to the steps in user's manual to reinstall the ribbon.</li> </ul>
<b>No Paper</b>	<ul style="list-style-type: none"> <li>* Running out of label.</li> <li>* The label is installed incorrectly.</li> <li>* Gap/black-mark sensor is not calibrated.</li> </ul>	<ul style="list-style-type: none"> <li>* Supply a new label roll.</li> <li>* Please refer to the steps in user's manual to reinstall the label roll.</li> <li>* Calibrate the gap/black-mark sensor.</li> </ul>
<b>Paper Jam</b>	<ul style="list-style-type: none"> <li>* Gap/black-mark sensor is not set properly.</li> <li>* Make sure label size is set properly.</li> <li>* Labels may be stuck inside the printer mechanism.</li> </ul>	<ul style="list-style-type: none"> <li>* Calibrate the gap/black-mark sensor.</li> <li>* Set label size correctly.</li> </ul>
<b>UP: Fwd.</b> <b>DOWN: Rev.</b> <b>MENU: Exit</b>	<ul style="list-style-type: none"> <li>* Cutter jam.</li> <li>* There is no cutter installed on the printer.</li> <li>* Cutter PCB is damaged.</li> </ul>	<ul style="list-style-type: none"> <li>* If the cutter module is installed, please press UP or DOWN key to rotate the cutter up or down to make the knife back to the right position.</li> <li>* Remove the label.</li> <li>* Make sure the thickness of label is less than 0.254 mm (10mil)</li> <li>* Replace a cutter PCB.</li> </ul>



<p><b>Not Printing</b></p>	<ul style="list-style-type: none"> <li>* Cable is not well connected to serial or USB interface or parallel port.</li> <li>* The serial port cable pin configuration is not pin to pin connected.</li> </ul>	<ul style="list-style-type: none"> <li>* Re-connect cable to interface.</li> <li>* If using serial cable, <ul style="list-style-type: none"> <li>- Please replace the cable with pin to pin connected.</li> <li>- Check the baud rate setting. The default baud rate setting of printer is 9600,n,8,1.</li> </ul> </li> <li>* If using the Ethernet cable, <ul style="list-style-type: none"> <li>- Check if the Ethernet RJ-45 connector green LED is lit on..</li> <li>- Check if the Ethernet RJ-45 connector amber LED is blinking.</li> <li>- Check if the printer gets the IP address when using DHCP mode.</li> <li>- Check if the IP address is correct when using the static IP address.</li> <li>- Wait a few seconds let the printer get the communication with the server then check the IP address setting again.</li> </ul> </li> <li>* Change a new cable.</li> <li>* Ribbon and media are not compatible.</li> <li>* Verify the ribbon-inked side.</li> <li>* Reload the ribbon again.</li> <li>* Clean the printhead.</li> <li>* The print density setting is incorrect.</li> <li>* Printhead's harness connector is not well connected with printhead. Turn off the printer and plug the connector again.</li> <li>* Check if the stepping motor is plugging in the right connector.</li> <li>* Check your program if there is a command PRINT at the end of the file and there must have CRLF at the end of each command line.</li> </ul>
<p><b>Memory full ( FLASH / DRAM )</b></p>	<ul style="list-style-type: none"> <li>* The space of FLASH/DRAM is full.</li> </ul>	<ul style="list-style-type: none"> <li>* Delete unused files in the FLASH/DRAM.</li> <li>* The max. numbers of file of DRAM is 256 files.</li> <li>* The max. user addressable memory space of DRAM is 2048 KB.</li> <li>* The max. numbers of file of FLASH is 256 files.</li> <li>* The max. user addressable memory space of FLASH is 6656KB.</li> </ul>
<p><b>SD card is unable to use</b></p>	<ul style="list-style-type: none"> <li>* SD card is damaged.</li> <li>* SD card doesn't insert correctly.</li> <li>* Use the non-approved SD card manufacturer.</li> </ul>	<ul style="list-style-type: none"> <li>* Use the supported capacity SD card.</li> <li>* Insert the SD card again.</li> <li>* The supported SD card spec. <ul style="list-style-type: none"> <li>- 128MB</li> <li>- 256MB</li> <li>- 512MB</li> <li>- 1GB</li> <li>- 4GB SDHC CLASS 6</li> </ul> </li> <li>* Approved SD card manufacturers; SanDisk, Transcend</li> </ul>
<p><b>PS/2 port does not work</b></p>	<ul style="list-style-type: none"> <li>* Did not turn off power prior to plug in the PS/2 keyboard.</li> <li>* PS/2 keyboard is damaged.</li> <li>* PS/2 keyboard doesn't plug-in correctly.</li> <li>* There is no BAS file in the printer.</li> </ul>	<ul style="list-style-type: none"> <li>* Turn off printer power prior to plug in the PS/2 keyboard</li> <li>* Plug the PS/2 keyboard again.</li> <li>* Make sure the keyboard is fine.</li> <li>* Make sure if there is any BAS file downloaded into printer.</li> </ul>

<p><b>Poor Print Quality</b></p>	<ul style="list-style-type: none"> <li>* Ribbon and media is loaded incorrectly</li> <li>* Dust or adhesive accumulation on the printhead.</li> <li>* Print density is not set properly.</li> <li>* Printhead element is damaged.</li> <li>* Ribbon and media are incompatible.</li> <li>* The printhead pressure is not set properly.</li> </ul>	<ul style="list-style-type: none"> <li>* Reload the supply.</li> <li>* Clean the printhead.</li> <li>* Clean the platen roller.</li> <li>* Adjust the print density and print speed.</li> <li>* Run printer self-test and check the printhead test pattern if there is dot missing in the pattern.</li> <li>* Change proper ribbon or proper label media.</li> <li>* Adjust the printhead pressure adjustment knob. <ul style="list-style-type: none"> <li>- If the left side printout is too light, please adjust the left side pressure adjustment knob to the higher index (higher pressure). If the pressure adjustment knob has been adjust to index "5" and the poor print quality is still at the left side of the printout, please adjust the pressure adjustment knob to index "1"</li> <li>- If the right side printout is too light, please adjust the right side pressure adjustment knob to the higher index (higher pressure) to improve the print quality.</li> </ul> </li> <li>* If the label thickness is more than 0.22 mm, the print quality might be not good enough, please adjust the heater line adjustment screw counter clockwise to get the best print quality.</li> <li>* The release lever does not latch the printhead properly.</li> </ul>
<p><b>LCD panel is dark and keys are not working</b></p>	<ul style="list-style-type: none"> <li>* The cable between main PCB and LCD panel is loose.</li> </ul>	<ul style="list-style-type: none"> <li>* Check if the cable between main PCB and LCD is secured or not.</li> </ul>
<p><b>LCD panel is dark but the LEDs are light</b></p>	<ul style="list-style-type: none"> <li>* The printer initialization is unsuccessful.</li> </ul>	<ul style="list-style-type: none"> <li>* Turn OFF and ON the printer again.</li> <li>* Initialize the printer.</li> </ul>
<p><b>LCD panel is dark and LEDs are lit on, but the label is feeding forward</b></p>	<ul style="list-style-type: none"> <li>* The LCD panel harness connector is loose.</li> </ul>	<ul style="list-style-type: none"> <li>* The LCD panel harness connector is plugged upside down.</li> </ul>
<p><b>Ribbon encoder sensor doesn't work</b></p>	<ul style="list-style-type: none"> <li>* The ribbon encoder sensor connector is loose.</li> </ul>	<ul style="list-style-type: none"> <li>* Fasten the connector.</li> </ul>
<p><b>Ribbon end sensor doesn't work</b></p>	<ul style="list-style-type: none"> <li>* The connector is loose.</li> <li>* The ribbon sensor hole is covered with dust.</li> </ul>	<ul style="list-style-type: none"> <li>* Check the connector.</li> <li>* Clear the dust in the sensor hole by the blower.</li> </ul>
<p><b>Cutter is not working</b></p>	<ul style="list-style-type: none"> <li>* The connector is loose.</li> </ul>	<ul style="list-style-type: none"> <li>* Plug in the connect cable correctly.</li> </ul>
<p><b>Label feeding is not stable (skew) when printing</b></p>	<ul style="list-style-type: none"> <li>* The media guide does not touch the edge of the media.</li> </ul>	<ul style="list-style-type: none"> <li>* If the label is moving to the right side, please move the label guide to left.</li> <li>* If the label is moving to the left side, please move the label guide to right.</li> </ul>
<p><b>Skip labels when printing</b></p>	<ul style="list-style-type: none"> <li>* Label size is not specified properly.</li> <li>* Sensor sensitivity is not set properly.</li> <li>* The media sensor is covered with dust.</li> </ul>	<ul style="list-style-type: none"> <li>* Check if label size is setup correctly.</li> <li>* Calibrate the sensor by Auto Gap or Manual Gap options.</li> <li>* Clear the GAP/Black-mark sensor by blower.</li> </ul>
<p><b>The left side printout position is incorrect</b></p>	<ul style="list-style-type: none"> <li>* Wrong label size setup.</li> <li>* The parameter Shift X in LCD menu is incorrect.</li> </ul>	<ul style="list-style-type: none"> <li>* Set the correct label size.</li> <li>* Press [MENU] → [SELECT] x 3 → [DOWN] x 5 → [SELECT] to fine tune the parameter of Shift X.</li> </ul>

<b>Missing printing on the left or right side of label</b>	* Wrong label size setup.	* Set the correct label size.
<b>RTC time is incorrect when reboot the printer</b>	* The battery has run down.	* Check if there is a battery on the main board.
<b>Multi interface board doesn't work</b>	* The installation is incorrect.	* Check if the board is plugged in the right connector.
<b>Power and Error LEDs are blinking fast</b>	* Power switch OFF and ON too fast.	* Turn off the printer and wait all LEDs are dark, and turn on the printer again.
<b>Wrinkle Problem</b>	* Printhead pressure is incorrect. * Ribbon installation is incorrect. * Media installation is incorrect. * Print density is incorrect. * Media feeding is incorrect.	* Make sure the label guide touch the edge of the media guide. * Make sure label, paper core and ribbon are set at the center of the spindle.
<b>Gray line on the blank label</b>	* The printhead is dirty. * The platen roller is dirty.	* Clean the printhead. * Clean the platen roller.
<b>Irregular printing</b>	* The printer is in Hex Dump mode. * The RS-232 setting is incorrect.	* Turn off and on the printer to skip the dump mode. * Re-set the Rs-232 setting.

## 5. MAINTENANCE

This session presents the clean tools and methods to maintain your printer.

1. Please use one of following material to clean the printer.

- Cotton swab (Head cleaner pen)
- Lint-free cloth
- Vacuum / Blower brush
- 100% ethanol

2. The cleaning process is described as following

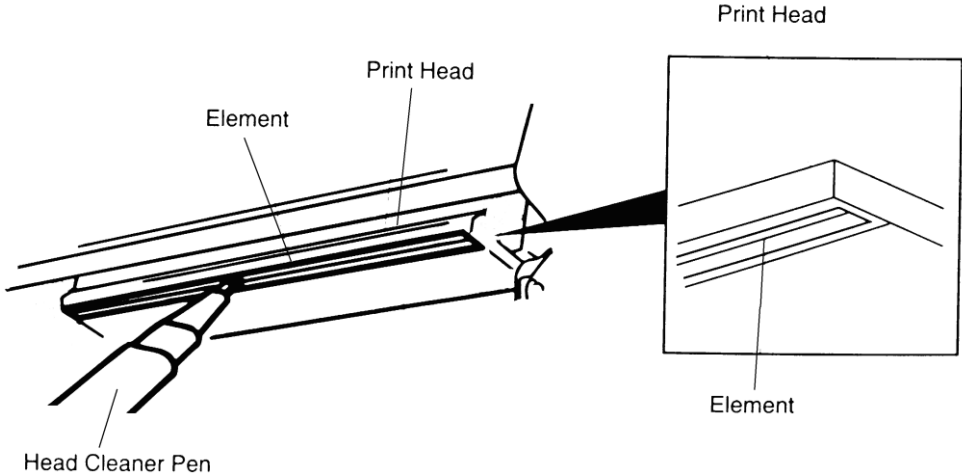
Printer Part	Method	Interval
<p><b>Print Head</b></p>	<p>1. Always turn off the printer before cleaning the print head.            2. Allow the print head to cool for a minimum of one minute.            3. Use a cotton swab (Head cleaner pen) and 100% ethanol to clean the print head surface.</p>	<p>Clean the print head when changing a new label roll</p>
		
<p><b>Platen Roller</b></p>	<p>1. Turn the power off.            2. Rotate the platen roller and wipe it thoroughly with 100% ethanol and a cotton swab, or lint-free cloth.</p>	<p>Clean the platen roller when changing a new label roll</p>
<p><b>Sensor</b></p>	<p>Compressed air or vacuum</p>	<p>Monthly</p>
<p><b>Exterior</b></p>	<p>Wipe it with water-dampened cloth</p>	<p>As needed</p>

<b>Interior</b>	Brush or vacuum	As needed
-----------------	-----------------	-----------

**Note:**

- Do not touch printer head by hand. If you touch it careless, please use ethanol to clean it.
- Please use 100% Ethenol. DO NOT use medical alcohol, which may damage the printer head.
- Regularly clean the print head and supply sensors once change a new ribbon to keep printer performance and extend printer life.

## UPDATE HISTORY

Date	Content	Editor
<b>2015/9/8</b>	* Modify section 3.11 (Installing cutter module) * Add section 3.12 (Replacing cutter driver IC board)	Camille
<b>2015/10/21</b>	Modify section 1.1 (Recommended SD card specification)	Camille
<b>2024/9/4</b>	Modify section 2.2 (GPIO)	Camille



